

# Design and Practical Evaluation of the PVT Concentrator System Concept

Alena Okhorzina<sup>1</sup>, Alexander Bikbulatov<sup>1</sup>, Alexey Yurchenko<sup>1,4</sup>, Wang Tai Dinh<sup>1</sup>,  
Ali Mekhtiev<sup>2</sup>, Aliya Alkina<sup>2</sup> and Yerkin Khidolda<sup>3</sup>

<sup>1</sup>National Research Tomsk Polytechnic University, Lenin Avenue 30, Tomsk, Russia,

<sup>2</sup>Faculty of Power Engineering, Automation and Telecommunications, Karaganda State Technical University,  
Mira blvd 56, Karaganda, Kazakhstan

<sup>3</sup>Kazakh National Research Technical University after K.I. Satpaev, Satpaev Str. 22, Almaty, Kazakhstan

<sup>4</sup>National Research Tomsk State University, Lenin Avenue 36, Tomsk, Russia  
ohra.avit@gmail.com, niipp@inbox.ru, barton.kz@mail.ru, alika\_1308@mail.ru

Keywords: PVT System, PV System, Concentrators, Thermal Performance.

Abstract: The purpose of this work is to propose a novel and effective photovoltaic-thermal hybrid solar system (PVT) with thermal and electrical output for small households. Such design allows the use of standard industrial photovoltaic modules in areas with low solar irradiation. The base of the system is a parabolic solar concentrator that increases the density of an irradiation flow on the photovoltaic module surface. To prevent the system from damage caused by overheating, redundant thermal energy can be used in a house heating system or should be removed by a cooler, boiler, etc. The proof of concept has been realized as a standalone PVT system with thermal and electrical output and successfully tested under natural conditions.

## 1 INTRODUCTION

Nowadays, the public consciousness is growing the conviction that the energy of the future should be based on large-scale use of solar energy, and in its most diverse manifestations. The sun is a huge, inexhaustible, safe source of energy. The growth rates of wind and solar energy in the world have been 30% or more for several years, which exceeds the growth rates of traditional coal and gas energy by an order of magnitude.

Reducing the cost of electricity production is possible in two ways: decreasing the cost of a solar battery and improving the efficiency of energy collection.

The implementation of the first method of possible ways [1]:

- Cost of production reduction - the creation of automated production plants;
- Cheaper silicon by replacing monocrystalline silicon by polycrystalline and multicrystalline silicon;
- Replacement of silicon by other materials, such as gallium arsenide.

As for the second method, you can increase efficiency [2]:

- Using tandem installations, multilayer photodetector at heterojunctions, although this increases the cost;
- Using a double-sided photoelectric converter, this significantly increases efficiency;
- Various concentrations are added, which are accompanied by an increase in generated energy, and accompanied by an increase in temperature, which negatively affects the efficiency;
- Introduced a tracking system for the sun.

## 2 DESCRIBE OF PVT SYSTEM

The installation is a hybrid system that converts solar energy into electricity and heat (Fig. 1). The sunlight falling silicon photovoltaic modules are converted into electricity. Production of heat occurs at the expense of the cooling of photovoltaic modules.

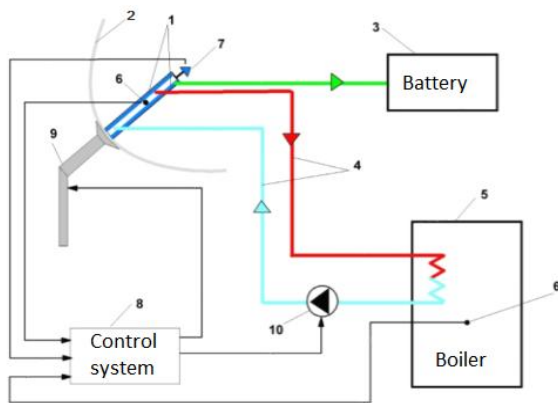

Figure 1: PV concentrator system with a heat sink: 1 is PV module, 2 is Concentrator, 3 is Accumulator Battery, 4 is Copper Tubes, 5 is Boiler, 6 is Temperature Sensors, 7 is Sensor of Tracking System, 8 is Control System, 9 is Rotating device, 10 is Pump.

The low concentrator is added to the system to increase energy production. The concentrator is a parabolic reflector.

Coming radiation flux falls on the concentrator and is reflected on the photovoltaic module. The plane of the solar module is located perpendicular to the flow of the reflected radiation. Direct light is not incident on a photovoltaic module.

The photovoltaic module consists of the two panels arranged in parallel to each other. The area between the photovoltaic modules is filled with the liquid. The photovoltaic modules are cooled by the liquid flow at the same time the liquid is heating.

The concentrator consists of two parabolic reflecting surfaces. The concentrator can be made of any material that meets the economic and operational tasks, such as metal or plastic with a reflective coating [2].

To increase the energy production is added in the low reflective concentrator. The concentrator provides increased density of the incoming solar energy flow in 2-3 times, thereby increasing the efficiency and the production of electricity. Also because of the increase in incoming solar flux on the surface of the PV module is heated; which leads to loss of efficiency and, when heated to a temperature above 130 °C, delamination or deterioration of elements of ohmic contacts photocells [1, 2].

The cooling system is a typical thermal solar system. Any liquid with a high specific heat capacity, such as glycol, mineral oil or water, can be used as a coolant. The easiest and most affordable option is water. Water is pumped from the bottom and moved upward by the pump. A configuration of cooling system is coil.

The control system consists of the several subsystems that control individual units. Harmonization of all subsystems is based on a microcomputer BeagleBon. Power for BeagleBon will be provided directly by PV modules as well as other sensors. The microcomputer will form a database of system and save it. That will optimize the system.

Management of PV: Battery control will be based on the MPPT-controller.

The system orientation to the sun is realized on the basis of the active tracking system [3]. The active system determines itself the position of the sun and issues a control signal to correct the position. Accordingly, the passive system works according to given astronomical data on the position of the sun during the day. Passive system is less effective on cloudy days.

The solar tracking system based on the photoelectric sensor. In our system we use three photovoltaic inverters A, B and C [4].

Control cooling system. The subsystem monitors the temperature of the coolant at the inlet and outlet of the solar panel [5, 6].

If the temperature difference at the inlet and outlet is less than the minimal value (approximately 5°), the pump power is decreased; if greater than the maximum value, it is increased (approximately 20°).

Authors see a prospect for alternative energy usage for small villages and private houses in distant and remote terrain (example, villages in a taiga, and houses of forestry officers in national parks).

### 3 THE MATHEMATICAL MODEL OF PVT SYSTEM

Numerical modeling of a PV concentrator system is designed with the help of Simulink/MatLab and is presented in [7]. MatLab works with matrix data and enables to create a custom calculated program. Simulink implements the principle of visual programming: the user uses the library to construct the model, configures the solver and calculation step.

The electrical model is based on the double exponential model of the photovoltaic cell. The model for the proposed range of the equivalent circuit elements, irradiance and temperature as model inputs, with the corresponding values of voltages, currents, and power as outputs is presented [8].

The voltage is set by uniformly time-varying signals. The current values are calculated for a definite voltage value at each step. The temperature effect is taken into account when modeling the photocurrent and diode saturation current [9]. Possible differences in the parameters of the diodes in the equivalent circuit are taken into account, as they have a significant impact on open-circuit voltage and power output.

The thermal model bases on the transfer of heat from hot to cold bodies. The model takes into account the heat flow from the heat protective glass flow and heat energy directly to the photovoltaic cells [10, 11]. In the thermal part of the calculated temperature value transmitted to the module and the electric part, wherein on the basis of this temperature is determined by the operating current and voltage.

#### 4 THE FIELD TEST FOR PVT SYSTEM

The field experiment was conducted. The experimental results have shown efficiency of the installation. A great influence on the electrical output has a minimal deviation from the direction of the sun (Fig. 2).



Figure 2: The concept of PVT system with concentrator.

The temperature of the photovoltaic modules was measured prior to testing and was 22 °C, which corresponds to the ambient temperature (Fig. 3).

At the first stage, the heating time of the entire system on a sunny, clear day was monitored using a concentrating system (Fig. 4 and Fig.5).

The temperature of both PV modules is the same (Fig. 4 and Fig. 5) since the concentrator reflects the same stream of sunlight and has an identical design. The tracking system also provides accurate position to the sun, which ensures the equality of energy that

comes to each concentrator. Therefore, thermograms for only one module will be given below.

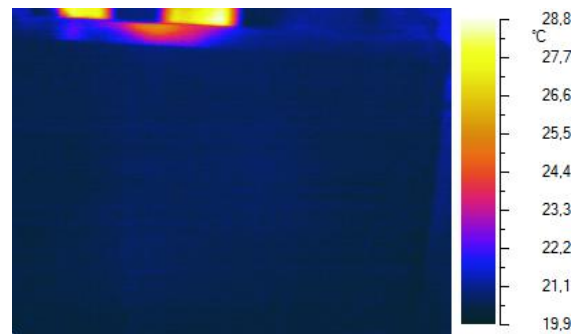

Figure 3: PV module in the initial state. Module temperature is equal to ambient temperature.

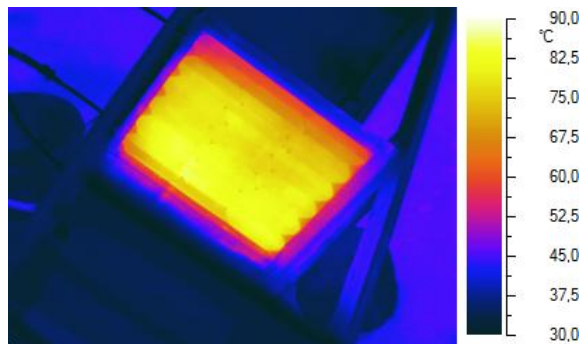

Figure 4: Operating, without cooling: Side A– 10 minutes.

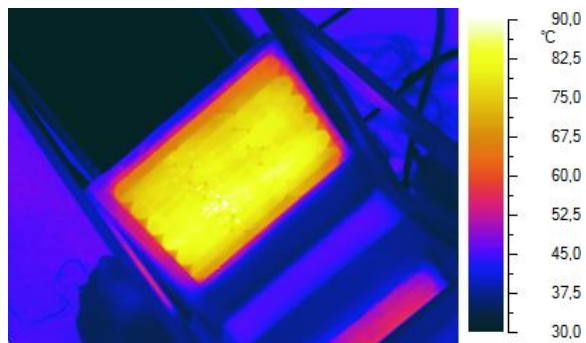

Figure 5: Operating, without cooling: Side B– 10 minutes.

At the second stage, the cooling system was connected, and observations were made on the quality of the cooling system (Fig. 6-8).

After the cooling system has been operating for 10 minutes (Fig. 6), the heating of the module has slightly decreased.

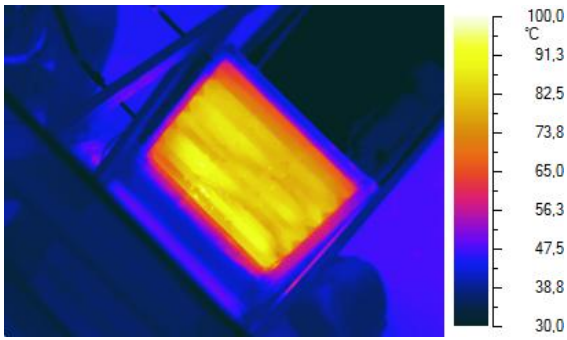

Figure 6: Operating with cooling: side A: Cooling - 10 minutes.

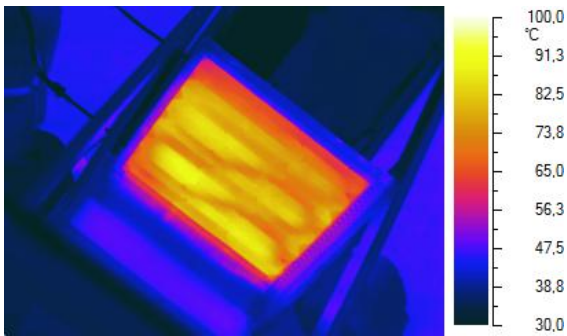

Figure 7: Operating with cooling: side A: Cooling - 15 minutes.

After the cooling system had been running from 15 minutes (Fig. 7), the heating of the module decreased. Maximum cooling is achieved in the zone of direct contact of the cooling tubes with the module. For better cooling, it is necessary to increase the area of this contact.

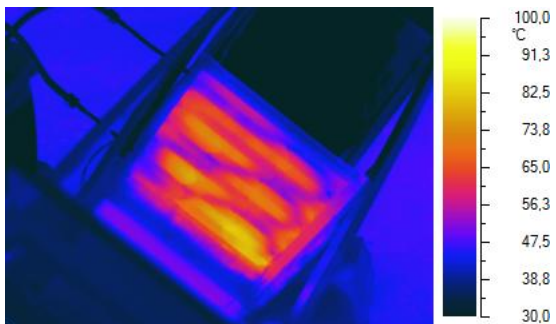

Figure 8: Operating with cooling: side A: Cooling - 50 minutes.

After the cooling system had been operated for 50 minutes (Fig. 8), the system went into balance. The temperature level of the modules remains the same. The average temperature is about 50°C, this

mode of operation does not lead to the destruction of the module structure and significant energy loss.

As a result of the field experiment, it was revealed that this system works. The heating of the PV modules surface with a 2-times concentration of solar radiation occurs quickly. Achieving a temperature that is dangerous for a photovoltaic device at a temperature of 90 °C occurs within 10 minutes (Fig. 3-5). When the temperature setting to 60 °C, power generation decreased by 8,2% and at a temperature of 90 °C decline in power output is 18%. When the cooling is turned on there is a significant cooling (about 30 °C).

According to the results of the experiment can be said that the cooling system is functioning well. To increase the cooling uniformity in the design can be changed or to add absorber, as well to augment the number of turns of the coil. It is possible constructive change of the system to provide more uniform cooling.

## 5 PVT OPERATION MANAGEMENT

The management system provides for the collection of information about the PVT system, the processing of information and the issuance of control actions. The central control unit is the BeagleBone Black mini-computer. The control system controls the orientation of the sun and cooling.

The priority of the cooling system is to keep the panel temperature below 60 °C. At the same time, if possible, the system will circulate in the system to ensure its heating for the consumer.

The priority of the tracking system is the accuracy of the orientation of the position of the sun for uniform and maximum energy production by each concentrator.

The system loop control algorithm is shown in Appendix.

First, the temperature sensor is read and the temperature  $t_0$  of the photovoltaic panel is calculated. The mode of operation of the pump is selected depending on what range is the temperature of the panel. For example, if the panel temperature is below 40 °C, cooling is not required and the pump is turned off. When the temperature rises, the pump speed automatically begins to increase, which provides more intensive cooling of the photovoltaic panel.

After performing the control and temperature adjustment, the program proceeds to the execution

of the system positioning algorithm. The solar tracking system based on the photoelectric sensor [4]. In our system we use three photovoltaic inverters A, B and C (Ipv\_1 is signal A, Ipv\_2 is signal B, Ipv\_3 is signal C). Two obverse of elements A and B define the position of the sun; the third rear element (C) accepts influence of scattered radiation. The signal of the received element C is subtracted from signals of the elements A and B. The device compares the signals and then generates a control signal to the motor (whether to east or to west), which directs the solar battery. The maximal signal from the rear element returns the solar module to its original position at sunrise

## 6 CONCLUSION

The proposed solution is a novel and effective PVT system aimed to use in small households as an electrical and thermal source.

To increase the efficiency of the PVT system, several methods have been applied:

- Solar tracking has been used to achieve smooth and highest straight irradiation.
- The parabolic solar concentrator has been used to increase the amount of incoming solar irradiation. As the negative impact such method leads to overheating of the PV module surface.
- The cooling system has been used to remove redundant and dangerous heat from the PV module surface and used in the house heating system.
- Control and monitoring system has been implemented under BeagleBone Black microcomputer. Such a platform is relatively cheap, flexible and easy to deploy.

The proof of concept has been implemented and tested under natural conditions. Experimental results show that usage of the proposed combined PVT system with an included parabolic concentrator and cooling system leads to a significant rise of the converting solar energy.

## REFERENCES

- [1] T. Markvart and L. Castafier, "Practical Handbook of Photovoltaics: Fundamentals and Applications" Elsevier Science Ltd., 2003, p. 985.
- [2] H.A. Zondag, "Flat-plate PV-Thermal collectors and systems: A review", *Renew Sustain Energy Rev*, 12, 2008, pp. 891-959.
- [3] L. Chia-Yen, Ch. Po-Cheng, Ch. Che-Ming and L. Chiu-Feng, "Sun tracking systems: A review", *Sensors*, no. 9, 2009, pp. 3875-3890.
- [4] M. Kitaeva, A. Yurchenko and A. Okhorzina, "Efficiency of PV systems with solar trackers for Russian regions", *Proceedings: 7th International Forum on Strategic Technology*, Tomsk: TPU Press, vol. 2, 2012, p. 103-106.
- [5] P. Dupeyrat, C. Mnzo, M. Rommel and H.M Henning, "Efficient single glazed flat plate photovoltaic-thermal hybrid collector for domestic hot water system" *Solar Energy*, vol. 85, 2011, pp. 1457-1468.
- [6] M. Rosa-Clot, P. Rosa-Clot and G.M. Tina "TESPI: thermal electric solar panel integration" *Solar Energy*, vol. 85, 2011, pp. 2433-2442.
- [7] A. Okhorzina, A. Yurchenko and N. Bernhard, "Numerical modelling of a PV concentrator system based on a dual-diode cell model taking into account cooling by a heat sink" *Proceedings of 31st European Photovoltaic Solar Energy Conference and Exhibition*, WIP Munich, 2015, pp. 1444-1447.
- [8] T. Salmi et al., "Matlab/Simulink based modelling of solar photovoltaic cell". *International journal of renewable energy research*, vol. 2, no. 2, 2012, p. 6.
- [9] H.L. Tsai, C.S. Tu and Y.J. Su, "Development of generalized photovoltaic model Using Matlab/Simulink, WCECS 2008, San Francisco, USA, p. 6, October 2008.
- [10] K. Kant, A. Shukla, A.Sharma and P.H. Biwol, "Heat transfer studies of photovoltaic panel coupled with phase change material", *Solar Energy*, vol. 140, 2016, pp. 151-161.
- [11] N. Gakkhar, M.S.Soni and S, Jakhar, "Analysis of water cooling of CPV cells mounted on absorber tube of a Parabolic Trough Collector" *Energy Procedia*, vol. 90, pp. 78-88, Desember 2016.

APPENDIX

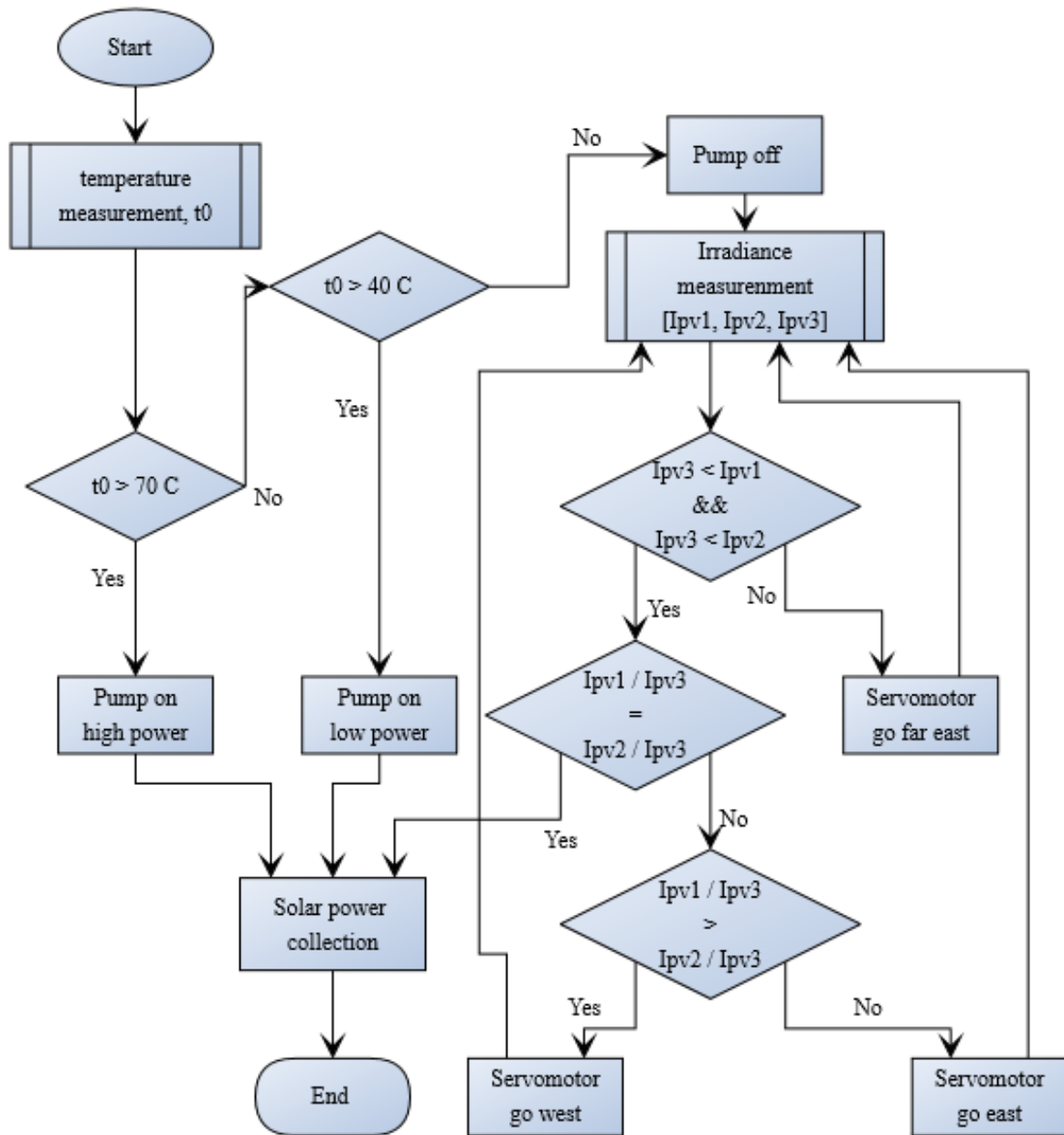

Figure A: Algorithm of PVT operate cycle.