

Methods to improve throughput and energy need in movement strategies of storage vehicle

Dissertation

zur Erlangung des akademischen Grades

Doktoringenieur

(Dr.-Ing.)

von M.Sc. Thanh Dung Cao

geb. am 16.05.1980 in Bac Giang, Vietnam

genehmigt durch die Fakultät für Maschinenbau
der Otto-von-Guericke-Universität Magdeburg

Gutachter:

Prof. Dr.-Ing. Hartmut Zadek

Prof. Dr.-Ing. habil. Thorsten Schmidt

Promotionskolloquium am 24.10.2018

Declaration of Honor

I hereby declare that I produced this thesis without prohibited external assistance and that none other than the listed references and tools have been used. I did not make use of any commercial consultant concerning graduation. A third party did not receive any nonmonetary perquisites neither directly nor indirectly for activities which are connected with the contents of the presented thesis.

All sources of information are clearly marked, including my own publications.

In particular, I have not consciously:

- Fabricated data or rejected undesired results
- Misused statistical methods with the aim of drawing other conclusions than those warranted by the available data
- Plagiarized data or publications
- Presented the results of other researchers in a distorted way

I do know that violations of copyright may lead to injunction and damage claims of the author and also to prosecution by the law enforcement authorities. I hereby agree that the thesis may need to be reviewed with an electronic data processing for plagiarism.

This work has not yet been submitted as a doctoral thesis in the same or a similar form in Germany or in any other country. It has not yet been published as a whole.

Magdeburg, 03.09.2018

M.Sc. Thanh Dung Cao

Acknowledgment

This work has been financially supported by Project No. 911, Ministry of Education and Training (MOET) of the Socialist Republic of Vietnam. I wish to express my deep acknowledgment to MOET since its support was vital.

I wish to express my heartfelt gratitude to my supervisor, **Prof. Dr.-Ing. Hartmut Zadek**, who gave me the opportunity to work at Institute of Logistics and Material Handling Systems - Otto von Guericke University Magdeburg. Throughout my PhD project, he was a constant source of energy, ideals and enthusiasm. We had many fruitful discussions with large impact on the results of this work. It was my privilege to work under him.

I would like to warmly thank **Dipl.-Ing. Jörg Monecke**, who helped me to set up and perform my first experiments. Besides, he supported me in understanding the basics of the kinematic equations.

I also thank all my colleagues at Institute of Logistics and Material Handling Systems for the warmth they showed on me. We had a very friendly and relaxed atmosphere in our office as well as outside the university.

Last but not least, my whole-hearted gratitude goes to my family, who have been supporting me throughout my life. Without their unconditional love, encouragement and support, I would never have been able to come this far.

Due to the requirement for productivity and cost of goods, most industries have become more and more complete in terms of control process, rules and regulations. One of the important stages of the work process is the goods storage and retrieval phase. Saving the energy and increasing the throughput during the storage and retrieval phase are major factors affecting the productivity and cost of goods. As a result, it is more competitive for enterprises when the transportation cost in the storage and retrieval phase is reduced and the productivity is increased. Automated storage and retrieval vehicle plays an important role in the goods storage planning of logistics centers and warehouses. Depending on the requirements of storage goods, dimensions of the system and the vehicle parameters, different movement strategies of the vehicle are applied to achieve the high efficiencies of throughput and energy need.

When the storage and retrieval vehicle moves in distances for only the startup and braking phases, the speed does not reach the required input value and the kinematic parameters are adjusted differently from long distances to achieve the high efficiencies of the moving time and the energy need. A simulation model of the single operation cycle is created from the theory and the results of the experimental model at the Otto-von-Guericke University Magdeburg. It simulates the kinematic parameters, the power and the energy need of the vehicle based on the moving time. The energy recovery is included in this simulation. The analysis about effective methods to control the vehicle in the distances for only the startup, braking phases and to optimize the energy need by adjusting simultaneously the speed and the acceleration are shown by the results of the simulation model.

A simulation model of the double operation cycle developed from the simulation model of single operation cycle is established. From the theoretical formulas to determine the average values when the system is divided by the ABC zoning or the non-zoning and the results received from the simulation models, the average values of the throughput and the energy need in the operation cycles are shown. The efficient percentages of the average energy need and the average throughput of the movement strategies in the ABC zoning or the non-zoning are determined.

The logical choice between a storage position and a retrieval position in the double operation cycle is aimed at reducing the energy need and the moving time of the vehicle. To find the logical choice between the storage and retrieval positions in the double operation cycle, the energy need and the moving time of the vehicle in the double operation cycle are compared to the ones in the single operation cycle when the storage and retrieval positions are changed in the system. The efficiencies of choosing the storage

and retrieval positions to reduce the energy need and the moving time in the double operation cycle of the system are shown by the results of the simulation models and the specific analyses.

After the efficiencies of choosing between a storage position and a retrieval position in the double operation cycle are determined, this thesis focuses on determining the logical choice method among the storage and retrieval positions in the double operation cycle of the entire system. It is derived from simple choices for a few of the pairs and then extended to the entire system to achieve the best efficiencies of the energy need and the moving time. The efficiencies of the logical choice method among the storage and retrieval positions to reduce the energy need and the moving time in the double operation cycle of the system are shown out by the results of the simulation model and the specific analyses. The logical choice method of the pairs of the double operation cycle in the entire system is compared with the chaotic storage method when the system is divided by the time ABC zoning, the energy ABC zoning or the non-zoning to prove its advantages. As the advantages of the logical choice method, it can be put into practical applications depending on the throughput and the required number of the double operation cycles.

Aufgrund Anforderungen hinsichtlich Produktivität und Preis sind in den meisten Industrien die Lücken in Überwachungsprozessen, Regeln und Regularien geschlossen worden. Eine der wichtigen Etappen im Arbeitsprozess ist die Ein- und Auslagerung der Waren. Einsparung von Energie und Erhöhung des Durchsatzes während der Ein- und Auslagerung sind Hauptfaktoren, die Produktivität und Preis beeinflussen. Hieraus resultiert, dass ein Unternehmen wettbewerbsfähiger wird, wenn Transportkosten während Ein- und Auslagerung reduziert und die Produktivität erhöht werden. Die Regalbediengeräte spielen eine wichtige Rolle in der Planung der Warenlagerung in Logistikzentren und Lagerhallen. Abhängig von den Anforderungen der zu lagernden Waren, den Dimensionen des Systems und den Regalbediengerätparametern werden verschiedene Bewegungsstrategien angewandt, um hohe Effizienz im Warendurchsatz und Energiebedarf zu erlangen.

Wenn sich das Regalbediengerät in Distanzen bewegt, in denen es nur beschleunigt und bremst, erreicht die Geschwindigkeit nicht den nötigen Eingangswert und die kinematische Parameter werden anders eingestellt als auf großen Distanzen, um hohe Effizienz in Bewegungszeit und Energiebedarf zu erreichen. Ein Simulationsmodell des Einzelspiels wird aus der Theorie und die Ergebnisse in einem experimentellen Modell von der Otto-von-Guericke Universität Magdeburg entwickelt. Es simuliert die kinematische Parameter, die Leistung und den Energiebedarf des Regalbediengeräts abhängig von der Bewegungszeit. Die Energierückgewinnung ist auch ein Teil dieser Simulation. Die Ergebnisse des Simulationsmodells werden für die Analyse effektiver Methoden zur Ansteuerung des Regalbediengeräts in Distanzen, in denen nur der Brem- und Beschleunigungsvorgang stattfindet, benutzt. Daneben werden die Methoden zur Optimierung des Energiebedarfs bei gleichzeitiger Anpassung der Geschwindigkeit und Beschleunigung in der Simulation gezeigt.

Ein Simulationsmodell des Doppelspiels, das auf Grundlage des Einzelspiels entwickelt wurde, wurde eingeführt. Aus den theoretischen Formeln zur Ermittlung der Durchschnittswerte bei der Aufteilung des Systems nach der zeitlichen ABC-Zonierung oder der Nicht-Zonierung und den aus den Simulationsmodellen erhaltenen Ergebnissen werden die Durchschnittswerte des Durchsatzes und des Energiebedarfs in den Betriebszyklen gezeigt. In der ABC-Zonierung oder der Nicht-Zonierung werden die effizienten Prozentsätze des durchschnittlichen Energiebedarfs und des durchschnittlichen Durchsatzes der Bewegungsstrategien bestimmt.

Die logische Wahl zwischen einer Einlagerungsposition und einer Auslagerungsposition in dem Doppelspiel ist für die Reduzierung des Energiebedarfs und der Bewegungszeiten des Regalbediengeräts verantwortlich. Um die logische Wahl zwischen den Ein- und Auslagerungspositionen in dem Doppelspiel zu finden, werden der Energiebedarf und die Bewegungszeit des Regalbediengeräts in dem Doppelspiel mit denjenigen in dem Einzelspiel verglichen, wenn die Ein- und Auslagerungspositionen im System geändert werden. Die Effizienz der Wahl zwischen der Ein- und Auslagerungspositionen zur Reduzierung des Energiebedarfs und der Bewegungszeit in dem Doppelspiel des Systems werden durch die Ergebnisse der Simulationsmodelle und der spezifischen Analyse gezeigt.

Nachdem die Effizienz der Auswahl zwischen einer Einlagerungsposition und einer Auslagerungsposition im Doppelspiel bestimmt sind, konzentriert sich diese Dissertation auf die Bestimmung des logischen Auswahlverfahrens zwischen den Ein- und Auslagerungspositionen im Doppelspiel des gesamten Systems. Es wird aus einfachem Wählen für einige der Paare abgeleitet und dann auf das gesamte System ausgedehnt, um die höchste Effizienz des Energiebedarfs und der Bewegungszeit zu erreichen. Die Effizienz des logischen Auswahlverfahrens zwischen Ein- und Auslagerungspositionen zur Reduzierung des Energiebedarfs und der Bewegungszeit im Doppelspiel des Systems werden durch die Ergebnisse des Simulationsmodells und der spezifischen Analysen gezeigt. Das logische Auswahlverfahren der Paare des Doppelspiels im gesamten System wird mit dem chaotischen Einlagerungsverfahren verglichen, wenn das System durch die zeitliche ABC-Zonierung, die energetische ABC-Zonierung oder der Nicht-Zonierung unterteilt wird, um seine Vorteile zu beweisen. Aus den Vorteilen des logischen Auswahlverfahrens kann es in Abhängigkeit von dem Durchsatz und der erforderlichen Anzahl der doppelten Spiele in die praktische Anwendung gebracht werden.

Table of contents

Declaration of Honor	i
Acknowledgment	ii
Abstract	iii
Kurzfassung	v
Table of contents	vii
Nomenclature	xi
List of Figures	xix
List of Tables	xxiii
1 Introduction	1
1.1 Motivation and scope	1
1.2 Research method and structure of the dissertation	3
2 Automatic small parts warehouse in Intralogistics	5
2.1 Concept of Intralogistics	6
2.2 Automatic small parts warehouse.....	7
2.3 Storage and retrieval machine in the automatic small parts warehouse.....	10
2.4 Literature review about the throughput and the energy efficiency of automatic small parts warehouse	17
2.4.1 Throughput of the system	17
2.4.2 Energy efficiency of the system	19
2.5 Storage operation strategies and the effect of the different operating conditions of the vehicle to the storage and retrieval system	23
2.5.1 Classical warehouse operation strategies.....	25
2.5.1.1 Warehouse management strategies.....	25
2.5.1.2 Movement strategies.....	29
2.5.2 Affecting of the different operating conditions	31
2.5.2.1 Input/output point's position	31
2.5.2.2 Moving distance of the vehicle.....	31
2.5.2.3 Speed of the vehicle.....	32

2.5.2.4	Acceleration of the vehicle	32
2.5.2.5	Mass of the goods	33
2.5.2.6	High effective combinations.....	33
3	Establishing the mathematical models to determine the storage vehicle parameters in the single operation cycle	35
3.1	Theoretical basis for determining typical parameters of the vehicle.....	35
3.1.1	Kinematic parameters	35
3.1.2	Power of the motors and energy need of the vehicle.....	43
3.2	Analyzing the working cases of the vehicle according to kinematic parameters..	47
3.2.1	When acceleration values in the acceleration and deceleration phases are quantitatively identical	47
3.2.2	When acceleration values in the acceleration and deceleration phases are quantitatively different	56
3.3	Block diagram of the simulation model when acceleration values in the acceleration and deceleration phases are quantitatively identical	58
3.4	Application of the simulation model of the vehicle at an experimental facility ...	60
3.4.1	Description of the experimental model.....	60
3.4.2	Determining the coefficients of the driving unit and the lifting unit.....	62
3.5	Model validation.....	63
4	Control the kinematic parameters of the vehicle to achieve high efficiencies and analyze the average energy need and throughput of working cycles.....	67
4.1	Vehicle moves in the distances for only the startup and braking phases	67
4.1.1	Driving unit.....	67
4.1.2	Lifting unit	70
4.2	Optimizing the energy need with the required time in the given distances	70
4.2.1	Driving unit.....	70
4.2.2	Lifting unit	75
4.3	Analyzing average energy need and average throughput of working cycles	77
4.3.1	Simulation model of the double operation cycle	78
4.3.2	Theoretical basis for determining the average values.....	79
4.3.3	Influence of the movement strategies	81
4.3.4	Combination of the single operation cycle and double operation cycle.....	87
5	Efficiencies of choosing the storage and retrieval positions in the double operation cycle	91

5.1	Energy need and the working time of the operation cycles	92
5.2	Efficiencies of choosing the positions in the double operation cycle	94
5.2.1	When vehicle moves firstly to one of any two defined positions P1 and P2....	94
5.2.2	When P1 and P2 are on the same height and P1 is fixed.....	95
5.2.3	When P1 and P2 are on the same height and s_{d12} is constant	97
5.2.4	When P1 and P2 are on the same length and P1 is fixed.....	98
5.2.5	When P1 and P2 are on the same length and s_{l12} is constant.....	101
5.2.6	When P1&P2 are located on a tilt line with the constant distance of P1P2 ...	101
5.2.7	When P1 is fixed and P2 changes.....	103
5.3	Summary	104
6	Logical choice method among the positions in the double operation cycle and its effective evaluation	105
6.1	Logical choice method among the positions of the double operation cycle	105
6.1.1	Some remarks before choosing the logical positions	106
6.1.2	Some cases to determine the logical choice method among the positions	108
6.1.3	Synthesizing the logical choice method among positions of double operation cycle	111
6.2	Efficiencies of the logical choice method among the positions in the double operation cycle	111
6.2.1	Efficiency of the logical choice method when the system is the non-zoning.	112
6.2.2	Efficiency of the logical choice method when the system is divided by the ABC zonings	115
6.2.2.1	When the system is divided by the time ABC zoning.....	115
6.2.2.2	When the system is divided by the energy ABC zoning	118
6.2.3	Average effective percentages of the storage methods in double operation cycle	122
6.2.3.1	Average effective percentages in the time ABC zoning compared to the non-zoning when chaotic storage method is performed.....	122
6.2.3.2	Average effective percentages in the ABC zoning compared to the non-zoning when logical choice method is performed.....	126
6.2.3.3	Average effective percentages of logical choice method in the ABC zoning compared to the ones of chaotic storage method in the non-zoning	129
6.2.3.4	Average effective percentages of chaotic storage method in the ABC zoning compared to the ones of logical choice method in the non-zoning..	132
6.2.4	Summary the efficiencies of the storage methods in double operation cycle.	135

6.2.5	Influence of the driving unit speed and the required number of the double operation cycles to throughput and energy need for the logical choice method .	137
7	Conclusion and outlook.....	141
7.1	Conclusion.....	141
7.2	Outlook.....	145
	References.....	148
	Appendices	154
	Appendix A: Positions to experiment and primary data from the experimental results	154
	Appendix B: The experimental coefficient of the driving unit	171
	Appendix C: Proof by Induction in Section 6.1.3	172
	Appendix D: The ABC zonings when kinematic parameters change.	174

Nomenclature

a	acceleration	m/s^2
a_{ac}	acceleration in acceleration phase	m/s^2
a_{achi}	achieved acceleration	m/s^2
a_{achi_ac}	achieved acceleration in acceleration phase	m/s^2
a_{achi_de}	achieved acceleration in deceleration phase	m/s^2
a_d	driving unit acceleration	m/s^2
$a_{d\text{inp}}$	input acceleration of the driving unit	m/s^2
$a_{d\text{max}}$	maximum acceleration of the driving unit	m/s^2
a_{de}	acceleration in deceleration phase	m/s^2
a_{inp}	input acceleration	m/s^2
a_l	lifting unit acceleration	m/s^2
$a_{l\text{inp}}$	input acceleration of the lifting unit	m/s^2
$a_{l\text{max}}$	maximum acceleration of the lifting unit	m/s^2
A_{ve}	frontal area of the vehicle	m^2
C_d	aerodynamic drag coefficient	-
d	diameter of the wheel gudgeon	m
d_j	diameter of the roller gudgeon	m
D	diameter of the wheel	m
D_j	diameter of the roller	m
\overline{DC}_{Combi}	average number of double operation cycle per hour in combination	-
E	energy need	kWs
E_{Dij}	energy need of the driving unit from position i to position j	kWs
E_{DC}	energy need of the double operation cycle	kWs
$E_{d\text{pos}}$	energy need of driving unit on one distance excluding energy recovery	kWs
$E_{d\text{reco}}$	energy recovery of the driving unit on one distance	kWs
$E_{dn\text{Exper}}$	energy recovery of the driving unit of the experimental model	kWs
$E_{dn\text{Simul}}$	energy recovery of the driving unit of the simulation model	kWs
$E_{dp\text{Exper}}$	energy consumption of the driving unit of the experimental model	kWs

$E_{dp\ Simul}$	energy consumption of the driving unit of the simulation model	kWs
E_{dri}	energy need of driving unit on one distance including energy recovery	kWs
$E_{in/out}$	energy need of picking goods into or out of the load handling device	kWs
E_{Ldif}	different energy need of the lifting unit by two choice ways of double operation cycle	kWs
E_{Lij}	energy need of the lifting unit from position i to position j	kWs
$E_{l\ pos}$	energy need of the lifting unit on one height excluding energy recovery	kWs
$E_{l\ reco}$	energy recovery of the lifting unit on one height	kWs
E_{lift}	energy need of the lifting unit on one height including energy recovery	kWs
$E_{ln\ Exper}$	energy recovery of the lifting unit of the experimental model	kWs
$E_{lp\ Exper}$	energy consumption of the lifting unit of the experimental model	kWs
E_{SC}	energy need of single operation cycle	kWs
E_{TSC}	total energy need of two single operation cycles	kWs
E_{TDC}	total energy need of two double operation cycles	kWs
\overline{E}_{Combi}	average energy need per unit load of the combination	kWs/UL
$\overline{E}_{Combi\ h}$	average energy need per hour of the combination	kWh/h
\overline{E}_{DC}	average energy need per unit load of the double operation cycle	kWs/UL
$\overline{E}_{DC\ ABC}$	average energy need of double operation cycle in the ABC zoning	kWs/UL
$\overline{E}_{DC\ ABC\ t}$	average energy need of double operation cycle in the time ABC zoning	kWs/UL
$\overline{E}_{DC\ ABC\ h}$	average energy need per hour of double operation cycle in ABC zoning	kWh/h
$\overline{E}_{DC\ h}$	average energy need per hour of the doule operation cycle	kWh/h
\overline{E}_{LOG}	average energy need of logical choice method in double operation cycle	kWs/UL
$\overline{E}_{LOG\ ABC\ E}$	average energy need of logical choice method in the energy ABC zoning	kWs/UL
$\overline{E}_{LOG\ ABC\ t}$	average energy need of logical choice method in the time ABC zoning	kWs/UL
$\overline{E}_{LOG\ ABC\ h}$	average energy need per hour of logical choice method in ABC zoning	kWh/h
$\overline{E}_{LOG\ h}$	average energy need per hour of logical choice method	kWh/h
\overline{E}_{SC}	average energy need per unit load of the single operation cycle	kWs/UL
$\overline{E}_{SC\ ABC}$	average energy need of the single operation cycle in the ABC zoning	kWs/UL
$\overline{E}_{SC\ ABC\ h}$	average energy need per hour of the single operation cycle in the ABC zoning	kWh/h
$\overline{E}_{SC\ h}$	average energy need per hour of the single operation cycle	kWh/h
$\overline{\Delta E}_{DC_ABC-DC}$	efficient percentage of average energy need per unit load in ABC zoning compared to the non-zoning of double operation cycle	%
$\overline{\Delta E}_{DC_ABC-DC\ h}$	efficient percentage of average energy need per hour in ABC zoning compared to the non-zoning of double operation cycle	%

$\overline{\Delta E_{DC_ABC-L}}$	efficient percentage of average energy need of the chaotic storage method in the time ABC zoning compared to the logical choice method in the non-zoning	%
$\overline{\Delta E_{DC_ABC-Lh}}$	efficient percentage of average energy need per hour of the chaotic storage method in the time ABC zoning compared to the logical choice method in the non-zoning	%
$\overline{\Delta E_{DC_ABC-SC}}$	efficient percentage of average energy need in ABC zoning of double operation cycle compared to non-zoning of single operation cycle	%
$\overline{\Delta E_{DC_ABC-SC_ABC}}$	efficient percentage of average energy need per unit load of double operation cycle compared to single operation cycle in ABC zoning	%
$\overline{\Delta E_{DC-SC}}$	efficient percentage of average energy need per unit load of double operation cycle compared to single operation cycle	%
$\overline{\Delta E_{E_t}}$	effective percentage of average energy need of the time ABC zoning compared to the one of the energy ABC zoning in logical choice method	%
$\overline{\Delta E_{LC}}$	effective percentage of average energy need of logical choice method compared to chaotic storage method	%
$\overline{\Delta E_{LC h}}$	effective percentage of average energy need per hour of logical choice method compared to chaotic storage method	%
$\overline{\Delta E_{LC ABC h}}$	effective percentage of average energy need per hour of logical choice method compared to chaotic storage method in ABC zoning	%
$\overline{\Delta E_{LC ABC t}}$	effective percentage of average energy need of logical choice method compared to chaotic storage method in the time ABC zoning	%
$\overline{\Delta E_{L_ABC-DC}}$	efficient percentage of average energy need of logical choice method in the time ABC zoning compared to chaotic storage method in non-zoning	%
$\overline{\Delta E_{L_ABC-DC h}}$	efficient percentage of average energy need per hour of logical choice method in the time ABC zoning compared to chaotic storage method in non-zoning	%
$\overline{\Delta E_{L_ABC-L}}$	efficient percentage of average energy need of the time ABC zoning compared to the non-zoning in logical choice method	%
$\overline{\Delta E_{L_ABC-L h}}$	efficient percentage of average energy need per hour of the time ABC zoning compared to the non-zoning in logical choice method	%
$\overline{\Delta E_{SC_ABC-SC}}$	efficient percentage of average energy need per unit load of ABC zoning compared to the non-zoning in single operation cycle	%
F	total resistance forces	N
F_d	total resistance force impacting on vehicle	N
F_{dw}	resistance force by the rail slope angle	N
F_{f1}	friction force on the wheel-rail and in the bearing	N
F_{f2}	friction force on rolls-rails	N
F_g	resistance force of the earth's gravity	N
F_i	inertial resistance force on vehicle	N
F_{il}	inertial resistance force on lifting unit	N
F_l	total resistance force on lifting unit	N
F_r	resistance force when vehicle rotates to the other direction	N

F_{srj}	Force of rollers to rails	N
F_w	aerodynamic drag force on vehicle	N
$\sum F_{ext}$	other resistance forces on vehicle	N
$\sum F_u$	other resistance forces on lifting unit	N
g	gravitational acceleration	m/s ²
H	height of system	m
K_l	experimental coefficient of lifting unit	-
K_{ll}	experimental coefficient of lifting unit when it lifts the goods	-
K_{lr}	experimental coefficient of lifting unit when it lowers the goods	-
k_{ra}	coefficient of the slope angle of rail	-
K_t	experimental coefficient of driving unit	-
K_{ta}	experimental coefficient of driving unit when it is acceleration	-
K_{tcs}	experimental coefficient of driving unit when speed is constant	-
K_{td}	experimental coefficient of driving unit when it is deceleration	-
L	length of system	m
m_l	mass of unit load	kg
m_{li}	mass of lifting unit	kg
m_{lmax}	maximum loading capacity	kg
m_{lm}	total mass of lifting unit and unit load	kg
m_t	total mass of vehicle and unit load	kg
m_v	mass of vehicle	kg
P	power of motor	W; kW
P_d	motor power of driving unit	W; kW
$P_{d\text{ Exper}}$	motor power of driving unit of the experimental model	W; kW
$P_{d\text{ Simul}}$	motor power of driving unit of the simulation model	W; kW
P_l	motor power of lifting unit	W; kW
$PE(\%)$	The saving energy percentage of double operation cycle compared to single operation cycle	%
$PEN(\%)$	The saving energy percentage of the first choice compared to the second choice in double operation cycle	%
$PMT(\%)$	The saving time percentage of the first choice compared to the second choice in double operation cycle	%
$PT(\%)$	The saving time percentage of double operation cycle compared to single operation cycle	%
\overline{Q}_{Combi}	average throughput per hour in the combination	UL/h

$\overline{Q_{DC}}$	average throughput per hour of double operation cycle	UL/h
$\overline{Q_{DC\ ABC}}$	average throughput per hour of double operation cycle in the ABC	UL/h
$\overline{Q_{DC\ ABC\ t}}$	average throughput per hour of double operation cycle in the time ABC zoning	UL/h
$\overline{Q_{LOG}}$	average throughput per hour of logical choice method	UL/h
$\overline{Q_{LOG\ ABC\ E}}$	average throughput of logical choice method in the energy ABC zoning	UL/h
$\overline{Q_{LOG\ ABC\ t}}$	average throughput of logical choice method in the time ABC zoning	UL/h
$\overline{Q_{SC}}$	average throughput per hour of single operation cycle	UL/h
$\overline{Q_{SC\ ABC}}$	average throughput per hour of single operation cycle in the ABC zoning	UL/h
$\overline{\Delta Q_{DC_ABC-DC}}$	efficient percentage of average throughput per hour of the ABC zoning compared to the non-zoning in double operation cycle	%
$\overline{\Delta Q_{DC_ABC-L}}$	efficient percentage of average throughput per hour of the chaotic storage method in the time ABC zoning compared to the logical choice method in the non-zoning	%
$\overline{\Delta Q_{DC_ABC-SC}}$	efficient percentage of average throughput per hour in the ABC zoning of double operation cycle compared to non-zoning of single operation cycle	%
$\overline{\Delta Q_{DC_ABC-SC_ABC}}$	efficient percentage of average throughput per hour of double operation cycle compared to single operation cycle in the ABC zoning	%
$\overline{\Delta Q_{DC-SC}}$	efficient percentage of average throughput per hour of double operation cycle compared to single operation cycle	%
$\overline{\Delta Q_{E_t}}$	effective percentage of average throughput of the time ABC zoning compared to the one of the energy ABC zoning in logical choice method	%
$\overline{\Delta Q_{LC}}$	effective percentage of average throughput of logical choice method compared to chaotic storage method in double operation cycle	%
$\overline{\Delta Q_{LC\ ABC\ t}}$	effective percentage of average throughput of logical choice method compared to chaotic storage method in the time ABC zoning	%
$\overline{\Delta Q_{L_ABC-DC}}$	efficient percentage of average throughput per hour of logical choice method in the time ABC zoning compared to chaotic storage method in the non-zoning	%
$\overline{\Delta Q_{L_ABC-L}}$	efficient percentage of average throughput per hour of the time ABC zoning compared to the non-zoning in logical choice method	%
$\overline{\Delta Q_{SC_ABC-SC}}$	efficient percentage of average throughput per hour in the ABC zoning compared to the non-zoning of single operation cycle	%
R^2	coefficient of determination	-
r	jerk	m/s ³
$r_{d\ imp}$	Jerk of driving unit	m/s ³
$r_{l\ imp}$	Jerk of lifting unit	m/s ³
s	distance	m
s_{ac}	acceleration distance	m
s_d	driving distance	m
s_{de}	deceleration distance	m

$S_{d\,inp}$	input distance of driving unit	m
S_{inp}	input distance	m
S_l	lifting distance	m
$S_{l\,inp}$	input distance of lifting unit	m
S_{sb}	distance for only the startup and braking phases of the vehicle	m
S_{v_const}	moving distance when speed is constant	m
$\overline{S}_{d\,P1P2}$	average distance of P1P2 in the horizontal	m
\overline{SC}_{Combi}	average number of single operation cycle per hour in the combination	-
t	time	s
t_{ac}	acceleration time	s
t_{DC}	working time of double operation cycle	s
t_{de}	deceleration time	s
t_{dri}	driving time of driving unit on one distance	s
$t_{d\,Exper}$	driving time of driving unit of the experimental model	s
$t_{d\,Simul}$	driving time of driving unit of the simulation model	s
t_{ij}	working time of the vehicle on one distance	s
$t_{in/out}$	time of picking goods into or out of vehicle	s
t_{lift}	lifting time of lifting unit on one distance	s
t_{SC}	working time of single operation cycle	s
t_{TDC}	total working time of two double operation cycles	s
t_{tot}	total moving time	s
t_{TSC}	total working time of two single operation cycles	s
t_{v_const}	moving time when speed is constant	s
\overline{t}_{DC}	average working time per unit load of double operation cycle	s/UL
$\overline{t}_{DC\,ABC}$	average working time of double operation cycle in the ABC zoning	s/UL
$\overline{\Delta t}_{DC-SC\,mo}$	efficient percentage of average moving time per unit load of double operation cycle compared to single operation cycle	%
\overline{t}_{SC}	average working time of single operation cycle	s/UL
$\overline{t}_{SC\,ABC}$	average working time of single operation cycle in the ABC zoning	s/UL
v	speed	m/s
v_{achi}	achieved speed	m/s
v_d	driving unit speed	m/s
$v_{d\,inp}$	input speed of driving unit	m/s

v_{dmax}	maximum speed of driving unit	m/s
v_{inp}	input speed	m/s
v_l	lifting unit speed	m/s
v_{linp}	input speed of lifting unit	m/s
v_{lmax}	maximum speed of lifting unit	m/s
v_w	longitudinal wind's speed	m/s
v_x	speed by horizontal	m/s
v_y	speed by vertical	m/s
w	parameter of rack	-

Greek symbols

f	coefficient of the rolling resistance friction between the wheel and the rail
f_j	coefficient of rolling resistance friction between roller and rail
μ_r	coefficient of the friction in the bearings
μ_{rj}	coefficient of the friction in the roller's bearings
η_l	general efficiency of lifting unit
η_t	general efficiency of system
ρ	mass density of air, kg/m ³
ρ_A	goods access frequency in zone A
ρ_B	goods access frequency in zone B
ρ_C	goods access frequency in zone C
ρ_{DC}	movement percentage of double operation cycle, %

Abbreviations

ABC t	the time ABC zoning
ABC E	the energy ABC zoning
ASPW	automatic small parts warehouse
ASRS	automatic storage and retrieval system
DC	the chaotic storage method applied in the non-zoning
DC_ABC	the chaotic storage method applied in the ABC zoning
DOC	double operation cycle
FEM	Fédération Européenne de la Manutention
FIFO	First in First out

GC-point	goods-out checking point
GI-point	goods-in identification point
I-point	Input point
I/O	Input/Output point
ILM	Institute of Logistics and Material Handling Systems
LHD	load handling device
LIFO	Last in First out
LOG	the logical choice method applied in the non-zoning
LOG_ABC	the logical choice method applied in the ABC zoning
O-point	Output point
SOC	single operation cycle
SRV	storage and retrieval vehicle
UL	unit load
VLAN	Wireless Local Area Network

List of Figures

Figure 2.1:	Energy consumption in Logistics.....	6
Figure 2.2:	Cost trade - offs required in a logistics system.....	7
Figure 2.3:	Automatic storage and retrieval system.....	9
Figure 2.4:	Shuttle system.....	10
Figure 2.5:	Movement directions of a storage and retrieval vehicle.....	11
Figure 2.6:	Different types of the stacker crane: single mast (a) and twin mast (b).....	12
Figure 2.7:	Development of the types of stacker cranes.....	13
Figure 2.8:	Stacker crane (SSI Schäfer).....	14
Figure 2.9:	LHDs of stacker cranes for handling containers, trays and cardboard.....	15
Figure 2.10:	Curved stacker cranes (a) and convertible stacker cranes (b).....	16
Figure 2.11:	Economic impacts of the energy efficiency.....	20
Figure 2.12:	The energy efficiency as a new requirement for logistics.....	21
Figure 2.13:	Process of selecting the classical warehouse operation strategies and the effect of the different operating conditions of SRV.....	24
Figure 2.14:	The Lorenz curve of the ABC zoning analysis.....	26
Figure 2.15:	Isochronal compartments.....	27
Figure 2.16:	Parameters of the rack.....	28
Figure 2.17:	The operating order of single and double operation cycles of SRV.....	30
Figure 3.1:	General illustration of distance, speed, acceleration and jerk by the time.....	37
Figure 3.2:	Differentiation of movement cases with identical magnitude of acceleration values.....	48
Figure 3.3:	The simplification of the speed curves in the acceleration and deceleration phases.....	48
Figure 3.4:	Example of movement curves when the speed and the acceleration do not reach the input values.....	49
Figure 3.5:	Example of movement curves when the speed does not reach the input speed and the acceleration reaches the input acceleration.....	51
Figure 3.6:	Example of movement curves when the speed is reached the input speed and the acceleration does not reach the input acceleration.....	53
Figure 3.7:	Example of movement curves when the speed and the acceleration reach the input values.....	55
Figure 3.8:	Differentiation of the movement cases when the acceleration values in the acceleration and deceleration phases are different.....	56
Figure 3.9:	Block diagram of simulation model of ASPW, when acceleration values in the acceleration and deceleration phases are quantitatively identical.....	58
Figure 3.10:	Automatic small parts warehouse (ASPW) at the Institute (ILM).....	60

Figure 3.11:	Comparison among the motor powers of the driving unit by the time when the input acceleration is 3 m/s^2	64
Figure 3.12:	Comparison among the driving times of the models by the storage compartments when the input acceleration is 2 m/s^2	64
Figure 3.13:	Comparison among the driving times of the models by the storage compartments when the input acceleration is 3 m/s^2	65
Figure 3.14:	Comparison among the energy need of the driving unit by the storage compartments when the input acceleration is 2 m/s^2	65
Figure 3.15:	Comparison among the energy need of the driving unit by the storage compartments when the input acceleration is 3 m/s^2	66
Figure 4.1:	Moving distances for only the startup and braking phases.....	68
Figure 4.2:	Relationship between the speed and the driving time when the distance is 3 m	71
Figure 4.3:	Relationship between the speed and the driving time when the distance is 8 m	71
Figure 4.4:	Relationship between the energy need and the driving time when the distance is 3 m and SRV has the energy recovery system.....	72
Figure 4.5:	Relationship between the energy need and the driving time when the distance is 3 m and SRV has not the energy recovery system.....	73
Figure 4.6:	Relationship between the energy need and the driving time when the distance is 8 m and SRV has the energy recovery system.....	73
Figure 4.7:	Relationship between the energy need and the driving time when the distance is 8 m and SRV has not the energy recovery system.....	74
Figure 4.8:	Relationship between the lifting unit speed and the lifting time when the height is 4.96 m (the eighteenth compartment).....	76
Figure 4.9:	Position of the storage and retrieval compartments.....	78
Figure 4.10:	Division of the ABC zoning in the storage and storage system.....	82
Figure 4.11:	Average energy need per unit load and average throughput per hour for chaotic storage.....	83
Figure 4.12:	Comparison the efficient percentages of average throughput per hour and average energy need per unit load for chaotic storage in the pairs of all cases...	86
Figure 4.13:	Average throughput per hour with variation of the driving unit speeds and the movement percentages of DOC for chaotic storage, transferring point X00Y02.....	88
Figure 4.14:	Average energy need per unit load with variation of the driving speeds and the movement percentages of DOC for chaotic storage, transferring point X00Y02	89
Figure 4.15:	Average energy consumption per hour with variation of driving speeds and movement percentages of DOC for chaotic storage, transferring point X00Y02.....	90
Figure 5.1:	Some specific positions of the storage and retrieval system.....	92
Figure 5.2:	P1 and P2 are on the same height and P2 is farther than P1.....	95
Figure 5.3:	P1 and P2 are on the same height and P1 is farther than P2.....	97
Figure 5.4:	P1 and P2 are on the same length and P2 is higher than P1.....	99
Figure 5.5:	P1 and P2 are on any position.....	102

Figure 6.1:	Cases of storage and retrieval positions vertically.....	107
Figure 6.2:	Cases of the storage and retrieval positions horizontally.....	108
Figure 6.3:	Average effective percentage of throughput in DOC of the logical choice method when the system is the non-zoning.....	113
Figure 6.4:	Average effective percentage of energy need per unit load in DOC of the logical choice method when the system is the non-zoning.....	115
Figure 6.5:	Average effective percentage of throughput in DOC of the logical choice method when the system is divided by the time ABC zoning.....	116
Figure 6.6:	Average effective percentage of the energy need per unit load in DOC of the logical choice method when the system is divided by the time ABC zoning.....	118
Figure 6.7:	Effective percentage of energy need per hour (kWh/h) of the logical choice method when the system is the non-zoning.....	121
Figure 6.8:	Effective percentage of energy need per hour (kWh/h) of the logical choice method when the system is divided by the time ABC zoning.....	122
Figure 6.9:	Average effective percentage of throughput in the time ABC zoning compared to one in the non-zoning when chaotic storage method is performed.....	123
Figure 6.10:	Average effective percentage of energy need per unit load in the time ABC zoning compared to one in the non-zoning when chaotic storage method is performed.....	124
Figure 6.11:	Average effective percentage of energy need per hour in the time ABC zoning compared to one in the non-zoning when chaotic storage method is performed.....	125
Figure 6.12:	Average effective percentage of throughput in the time ABC zoning compared to one in the non-zoning when the logical choice method is performed.....	126
Figure 6.13:	Average effective percentage of energy need per unit load in the time ABC zoning compared to one in the non-zoning when the logical choice method is performed.....	127
Figure 6.14:	Average effective percentage of energy need per hour in the time ABC zoning compared to one in the non-zoning when the logical choice method is performed.....	128
Figure 6.15:	Average effective percentage of throughput of logical choice method in the ABC zoning compared to one of chaotic storage method in the non-zoning.....	129
Figure 6.16:	Average effective percentage of energy need of logical choice method in the ABC zoning compared to one of chaotic storage method in the non-zoning.....	130
Figure 6.17:	Average effective percentage of energy need per hour of logical choice method in ABC zoning compared to one of chaotic storage method in non-zoning.....	131
Figure 6.18:	Average effective percentage of throughput of chaotic storage method in the ABC zoning compared to one of logical choice method in the non-zoning.....	133
Figure 6.19:	Average effective percentage of energy need per unit load of chaotic storage method in the ABC zoning compared to one of logical choice method in the non-zoning.....	134

Figure 6.20:	Average effective percentage of energy need per hour of chaotic storage method in ABC zoning compared to one of logical choice method in non-zoning.....	135
Figure 6.21:	Relationship of average effective percentages of throughput and energy need of the storage methods in DOC.....	135
Figure 6.22:	Average throughput per hour of logical choice method with variation of driving unit speeds and required number of DOCs, transferring point X00Y02 when the system is the non-zoning.....	137
Figure 6.23:	Average energy need per unit load of logical choice method with variation of driving unit speeds and required number of DOCs, transferring point X00Y02 when the system is the non-zoning.....	138
Figure 6.24:	Average throughput per hour of logical choice method with variation of driving unit speeds and required number of DOCs in the time ABC zoning, transferring point X00Y02.....	138
Figure 6.25:	Average energy need per unit load of logical choice method with variation of driving unit speeds and required number of DOCs in the time ABC zoning, transferring point X00Y02.....	139
Figure 6.26:	Average energy need per hour of logical choice method with variation of driving unit speeds and required number of DOCs, transferring point X00Y02 when the system is the non-zoning.....	139
Figure 6.27:	Average energy need per hour of logical choice method with variation of driving unit speeds and required number of DOCs in the time ABC zoning, transferring point X00Y02	140

List of Tables

Table 2.1:	The ABC-XYZ matrix.....	27
Table 3.1:	Important parameters of the system.....	61
Table 4.1:	Moving time and energy need when the speed changes.....	69
Table 4.2:	Moving time and energy need when the acceleration changes.....	69
Table 4.3:	Comparison of average throughput per hour and average energy need per unit load for chaotic storage in whole system of SOC and DOC.....	84
Table 4.4:	Comparison of average throughput per hour and average energy need per unit load for chaotic storage in ABC zoning of SOC and DOC.....	84
Table 4.5:	Comparison of average throughput per hour and average energy need per unit load for chaotic storage in whole system and in ABC zoning of SOC...	85
Table 4.6:	Comparison of average throughput per hour and average energy need per unit load for chaotic storage in whole system and in ABC zoning of DOC...	85
Table 4.7:	Comparison of average throughput per hour and average energy need per unit load for chaotic storage in whole system of SOC and in ABC zoning of DOC.....	85
Table 5.1:	Saving capacities of DOC when SRV moves firstly to one of any two defined positions.....	95
Table 5.2:	Saving capacities of moving time and energy need by horizontal direction of DOC.....	96
Table 5.3:	Saving capacities of the moving time and energy need by vertical direction of DOC.....	100
Table 5.4:	Saving capacities of moving time and energy need in the general cases of DOC.....	102
Table 6.1:	Some examples to determine logical choice method among four positions, when driving unit speed is 4 m/s and driving unit acceleration is 3 m/s ²	109
Table 6.2:	Comparison average throughput per hour between chaotic storage method and logical choice method in DOC when the system is the non-zoning.....	113
Table 6.3:	Comparison average energy need per unit load between chaotic storage method and logical choice method in DOC when the system is the non-zoning.....	114
Table 6.4:	Comparison average throughput per hour between chaotic storage method and logical choice method in DOC of the time ABC zoning.....	116
Table 6.5:	Comparison average energy need per unit load between chaotic storage method and logical choice method in DOC of the time ABC zoning.....	117
Table 6.6:	Comparison average throughput between the time ABC zoning and the energy ABC zoning in the logical choice method of DOC.....	119
Table 6.7:	Comparison average energy need between the time ABC zoning and the energy ABC zoning in the logical choice method of DOC.....	119

Table 6.8:	Comparison average energy need per hour between chaotic storage method and logical choice method in DOC when the system is the non-zoning.....	120
Table 6.9:	Comparison average energy need per hour between chaotic storage method and logical choice method in DOC of the time ABC zoning.....	121
Table 6.10:	Comparison average throughput per hour between the ABC zoning and the non-zoning when the chaotic storage method is performed.....	123
Table 6.11:	Comparison average energy need per unit load between the ABC zoning and the non-zoning when the chaotic storage method is performed.....	124
Table 6.12:	Comparison average energy need per hour between the ABC zoning and the non-zoning when the chaotic storage method is performed.....	125
Table 6.13:	Comparison average throughput per hour between the ABC zoning and the non-zoning when the logical choice method is performed.....	126
Table 6.14:	Comparison average energy need per unit load between the ABC zoning and the non-zoning when the logical choice method is performed.....	127
Table 6.15:	Comparison average energy need per hour between the ABC zoning and the non-zoning when the logical choice method is performed.....	128
Table 6.16:	Comparison average throughput per hour between chaotic storage method of the non-zoning and logical choice method of the ABC zoning.....	129
Table 6.17:	Comparison average energy need per unit load between chaotic storage method of the non-zoning and logical choice method of the ABC zoning....	130
Table 6.18:	Comparison average energy need per hour between chaotic storage method of the non-zoning and logical choice method of the ABC zoning.....	131
Table 6.19:	Comparison average throughput per hour between logical choice method of the non-zoning and chaotic storage method of the ABC zoning.....	132
Table 6.20:	Comparison average energy need per unit load between logical choice method of the non-zoning and chaotic storage method of the ABC zoning....	133
Table 6.21:	Comparison average energy need per hour between logical choice method of the non-zoning and chaotic storage method of the ABC zoning.....	134

Chapter 1

Introduction

1.1 Motivation and scope

The world is changing day by day, the natural resources are more limited and the environment is more polluted and as a result, the high science technologies are developing to meet the requirements of the modern world. These require countries, organizes and individuals to mobilize more resources to save natural resources, shorten working time, reduce cost. The scientists focus on researching methods to develop challenges in reserving the natural resources, particularly in the energy efficiency to provide new solutions and can foster it in all aspects.

The developed countries consider the energy efficiency as a keyword to speed up the sustainable strategies, in which the European Commission worked out the energy efficiency plan 2011: “Energy efficiency is at the heart of the EU’s Europe 2020 Strategy for smart, sustainable and inclusive growth and of the transition to a resource efficient economy. Energy efficiency is one of the most cost effective ways to enhance security of energy supply and to reduce emissions of greenhouse gases and other pollutants” [1]. To achieve the energy efficiency, the energy need and the throughput are potential and play an important role in the operation strategies of the companies due to the costs of the energy and the labor force are increasing. They directly affect the productivity, the cost of goods and the greenhouse gas emissions.

Reducing energy need and increasing throughput are to increase the energy efficiency per unit of product. Therefore, most industries have become more and more complete in the work process to reduce the energy need and increase the throughput, particularly the work process is more concerned in the logistics companies due to the high logic requirements. One of the important steps of the work process in the logistics companies is the storage and retrieval phase. Saving the energy and reducing the moving time during the storage and retrieval phase are major factors affecting to the productivity, the cost of goods and the greenhouse gas emissions. It helps companies bring their products onto the market more competitively when the transportation cost in the storage and retrieval phase is reduced and the productivity is increased respectively. In addition, the energy efficiency products and services are increasingly preferred to use by the customers.

To store and distribute goods in the logistics companies, the warehouses are gradually being automated, in which, automatic small parts warehouse (ASPW) has many advantages such as: traveling speedily in long distances and in heights of the storage and retrieval vehicle (SRV); storing, supplying and carrying stock instantly. ASPWs facilitate the delivery of products (items, cases or pallets), saving the space; increasing the productivity and the competitiveness. They can be installed in process plants, production or assembly, or in distribution centers.

The storage and retrieval vehicle is at the heart of ASPW. An automatic small parts warehouse works effectively depending on the operation strategies of SRV. The efficiency of the vehicle's operation strategies is reflected in the energy need and the throughput of the system. The throughput of automatic storage and retrieval system (ASRS) has been researched extensively but the energy efficiency is still a new factor for many companies. In particular, the combination of increasing productivity and reducing energy need brings the highest efficiency of the system. However, the studies on this combination of SRV have only been considered in some aspects as the separate study on the kinematic parameters or the effect of the input and output points on the efficiency of the energy need and the throughput. The criteria for the energy need and the throughput in warehouse operation strategies are evaluated accordingly [2,3]. There are still lacks of research to improve the efficiency of the throughput and the energy need such as:

The specific relationship between the energy need and the moving time shown out by the simultaneous adjustment of the speed and the acceleration in order to achieve the best energy efficiency in the single operation cycle (SOC);

The moving time of SRV depends mainly on the acceleration when it moves in the distances for only the startup and braking phases and in this case, the stability speed phase on the way does not appear. The kinematic parameters should be adjusted by the new measures in these distances to change the moving time and reduce the energy consumption accordingly;

The distance among the storage and retrieval positions has not been specifically analyzed to reduce the energy need and the moving time in double operation cycle (DOC) when the storage and retrieval positions are chosen in pairs, etc.

To meet the requirements of using the energy efficiency, these above factors should be considered thoroughly and the scope is worked out to reduce the energy need and increase the throughput of SRV.

1.2 Research method and structure of the dissertation

The research results of the dissertation are derived from simulation models of SOC and DOC, which are established from the theory and the data of the experimental model to simulate the kinematic parameters, the power and the energy of SRV by the moving time. After that, the warehouse operation strategies are shown to improve the throughput and the energy need.

The dissertation is organized and described as follows:

In Chapter 2, the concept of Intralogistics and the importance of an automatic small parts warehouse in Intralogistics are introduced. A detailed literature review of the throughput and the energy need of the storage and retrieval system is shown after the storage and retrieval vehicle is presented. The classic storage operation strategies and the effect of the different operating conditions of SRV to the storage and retrieval system are mentioned accordingly.

In Chapter 3, a simulation model to determine the storage vehicle parameters in SOC is established. Firstly, the theoretical basis for typical parameters of SRV is calculated. Secondly, the block diagram of the simulation model is established after the working cases of SRV according to the kinematic parameters are analyzed. Finally, the simulation model is applied to an experimental model to validate its reliability.

In Chapter 4, from the data of the simulation model in SOC, the kinematic parameters of SRV are analyzed in different ways to achieve the high efficiencies of the throughput and the energy efficiency. And then, the average energy need and the average throughput of working cycles also are analyzed to clarify the effectiveness of the strategies after the double operation cycle is established.

In Chapter 5, the choice between a storage position and a retrieval position in DOC of SRV are analyzed. In this section, the energy need and the moving time of SRV in DOC are compared to the ones in SOC when the storage and retrieval positions are changed in every compartment of the system. After that, the relationship between the storage and retrieval positions to achieve the high efficiencies of the energy need and the throughput is discussed in detail.

In Chapter 6, the logical choice method among storage and retrieval positions of DOC in the entire system is considered to reduce the energy need and increase the throughput of

SRV. The method of choosing the pairs of DOC is derived from simple choices with a few of the compartments. And then, it is extended to the entire system to achieve the best efficiencies of the energy need and the moving time. The efficiencies of the logical choice method among the positions in DOC are considered in detail as well.

Chapter 7 presents the conclusion, which is obtained from the dissertation and suggestions for future work are also made.

Chapter 2

Automatic small parts warehouse in Intralogistics

Logistics defined by the Council of Logistics Management, 1991 is a process of planning, implementing and controlling the efficient, effective flow and storage of goods, services, and related information from point of origin to point of consumption for the purpose of conforming to customer requirements [4,5].

Nowadays, logistics represents an important factor in terms of competitiveness and economy for manufacturing companies as well as commercial enterprises. This mainly lies in the dynamic market development caused, among others, by globalization. Those changes result in extremely high-level requirements towards logistics [6].

In a logistics center, the goods receiving, processing, storage, order picking, packaging and shipping are performed as the main functions. The standard operating services are warehousing, order picking and handling of goods. The corresponding operating service areas include the goods receipt and storage, transport systems, sorting systems and goods distribution. Based on these above service areas, the following services can be the quality assurance, goods processing, filling and packaging, packing, unpacking and repacking, assembling, repairing, returning and complaints processing [2,7].

All above mentioned functions and areas can be performed not only in logistic centers, but also in the warehouses of the companies. The industry's real potentiality for cost-reduction and innovation lies in the warehouses. They are as a part of internal logistics, the so-called "Intralogistics".

2.1 Concept of Intralogistics

Regarding the logistics-journal, Intralogistics describes the organization, realization and optimization of internal material flow and logistic technologies as well as the goods transshipment in industry, trade and in public institutions by means of technical components, partial and full systems and services [8]. In addition, Intralogistics is the art of optimizing, integrating, automating, and managing the logistical flow of information and material goods within the walls of a fulfillment or distribution center [9]. In the frame of "Supply Chain Management" Intralogistics controls the material flow along the complete value-added chain. Intralogistics is the term of a trendsetting industry which in Germany alone comprises thousands of companies, from manufacturers of lifting devices and cranes, forklift trucks and warehouse technology up to software developers and providers of complete systems [8]. Intralogistics, the most important link in comprehensive supply chains, is the heart of the supply chain. Intralogistics requires a high degree of operational control - the highly complex interlocking processes of Intralogistics must be perfectly coordinated and constantly respond to changing market conditions since the entire supply chain depends on them [10].

Complex delivery strategies require one hundred percent efficient supply chains. The rule of a chain being as strong as its weakest link can be transferred to supply chains. Consequently, the requirements concerning reliability and availability of each link increase, because logistics services cannot be produced to stock. This applies to production facilities and particularly to their Intralogistics systems, which ensure the in-house flow of material and information. Experts agree on Intralogistics being the crucial element of a successful supply chain and its bottleneck at the same time [6].

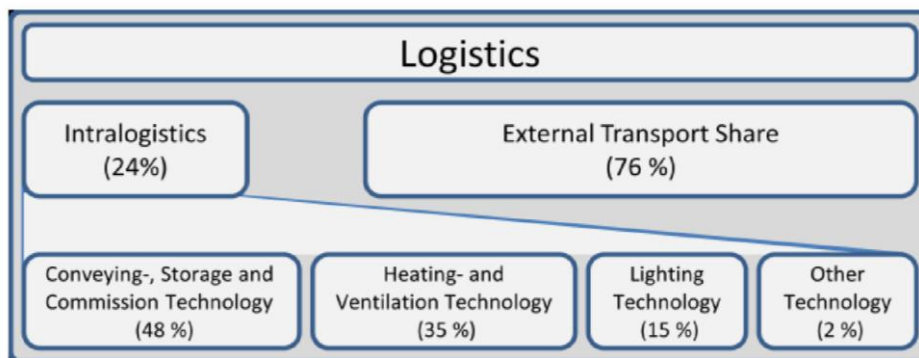

Figure 2.1: Energy consumption in Logistics [11].

In Logistics, Intralogistics is calculated for about 24% of energy consumption and the conveying, storage and commission technology of manufacturing plants is part of the activities in the category of Intralogistics. It contains potentials with great impact. As it can be seen on the basis of the analysis in Figure 2.1, it consumes about 48% of Intralogistics costs. Besides, the heating - and ventilation engineering consumes about 35 % and lighting

engineering consumes about 15 % of Intralogistics. On closer inspection of these areas in most of the factories potentials do exist and could be changed without bigger efforts and investments [11].

For Intralogistics systems, the technical logistics provides the function modules for the conveying, storage, picking and sorting techniques including the necessary control and information technologies [2,12]. The automatic small parts warehouses are designed to perform these functions.

2.2 Automatic small parts warehouse

Warehouse is an integral part of every logistics system. It plays a vital role in providing a desired level of customer service at the lowest possible total cost. The warehousing activity is the link between the producer and the customer (Fig. 2.2). Warehouse stores products (raw materials, parts, goods-in-process, finished goods) at and between point-of-origin and point-of-consumption, and provides information to management on the status, condition, and disposition of items being stored [13].

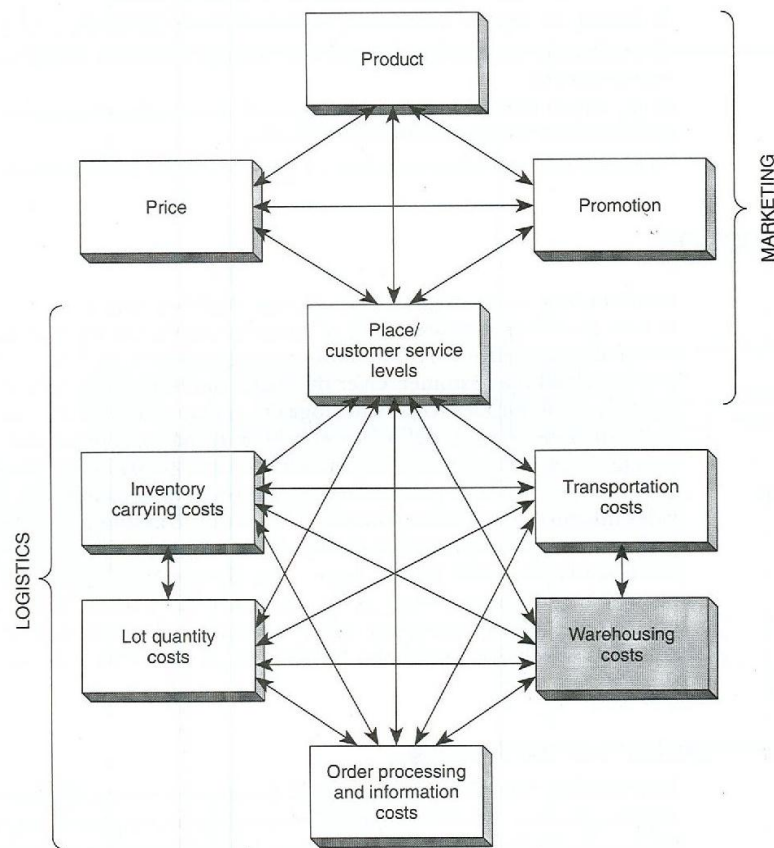

Figure 2.2: Cost trade - offs required in a logistics system [13].

Warehouse should be operated to meet defined objectives, which may be to achieve any or a combination of such things as a defined level of customer service, a given throughput level, a given stock level or a minimum cost of operation. Meeting such objective requires

the appropriate storage and handling methods and equipment in a properly planned and controlled system of operation and an appropriate and secure environment [14].

Regarding the material group and the product, it can be necessary to have several warehouses available. One of the reasons for appliance of multiple warehouses is the specific product which has to be stored [11]. In recent years, the trend for the warehouse design has moved towards high bay racking, which reduces the energy demand in combination with software applications [11,15]. The high bay racking is necessary due to the demand for space increases, while available space decreases at the same moving time.

Benefits realized from the strategic warehouse are classified on the basis of economics and service. Economic benefits of the warehouse result when overall logistics costs are directly reduced by utilizing one or more facilities. It is not difficult to quantify the return-on-investment of an economic benefit because it is reflected in a direct cost-to-cost trade-off. Service benefits gained from warehouses in a logistical system are primarily justified on the supporting rationale that the time and place capabilities of the overall logistical system are improved [16].

In general, warehouse has many types of operation from manual to semi-automatic and automatic. In order to improve the productivity and reduce the labor force of the workers, warehouses are gradually being automated and they are divided into three categories as follows: The first type of the warehouses is automatic high-bay warehouse used for the industrial pallets. The weight of these pallets is usually from 300 to 3.000 kg. The warehouses can be built up to a height of 50 m. The second type of the warehouses is silo structure warehouse. It has lower height and usually higher than 18 m. It is possible for tray to reach up to 300 kg in weight. The third type of the warehouses is automatic small parts warehouse (ASPW). An automatic small parts warehouse is designed for lightweight and small units up to 50 kg that are stored in totes, cardboard boxes or on trays depending on the goods type, weight, requirements of throughput and application field. The height is usually below 18 m [17].

For three above types, the first type and the second type are not subject to study in this topic. The automatic small parts warehouse is increasingly used in the Intralogistics to guarantee the high profitability due to its suitable storage characteristics and optimal existing storage space.

An automatic small parts warehouse is an automatic storage and retrieval system including the following components (Fig. 2.3): the warehouse front zone consists of the goods-in identification point (GI - point), the distribution area of the storage goods, the collection area of the retrieval goods, the goods-out checking point (GC - point), the goods receipt area and the goods issue area. The areas of goods receipt and goods issue are unnecessary to be part of the storage system. They are usually separated in other areas of the factory. The shelf zone includes the input point (I) or the pick-up location for goods to be stored,

the racks and the output point (O) or the transfer location for goods retrieved. I and O are usually located at the same location as an input and output point (I/O point) [2,18].

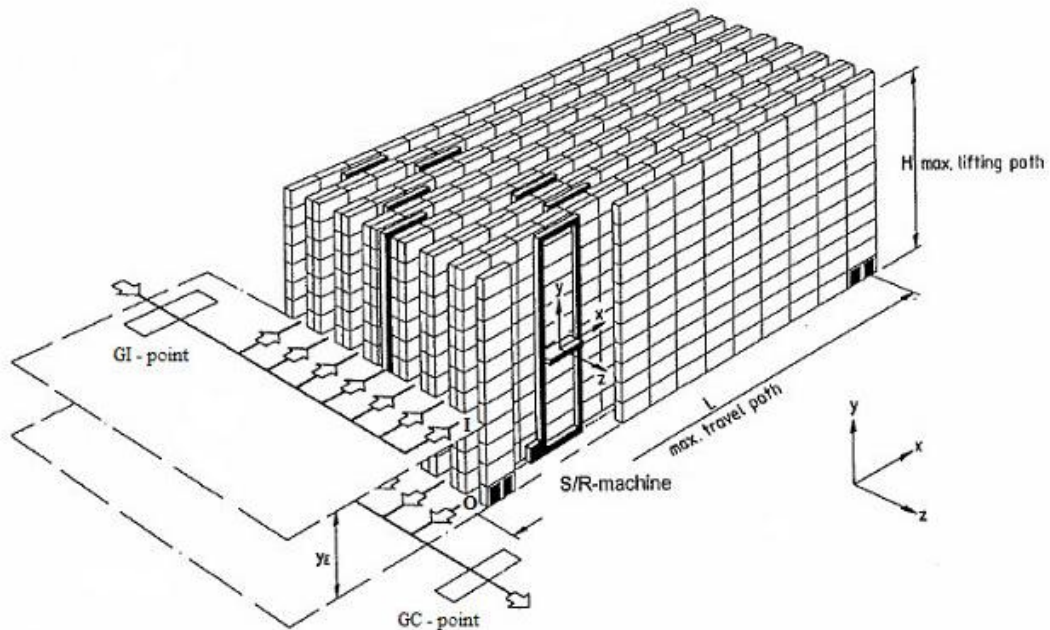

Figure 2.3: Automatic storage and retrieval system [19].

A goods receipt and a quality inspection are carried out at the goods receipt area. Besides, unit loads (ULs) are formed, labeled and then checked (e.g. profile or weight) at the GI – point. The goods and data (e.g. goods, quantity and storage date) are linked together. The distribution area of the storage goods includes the conveyor area and the storage buffers in front of the aisle of the warehouse. The collection area of the retrieval goods also includes the conveyor area and the retrieval buffers in front of the aisle of the warehouse. The devices of the distribution area and the collection area can be shared or used separately. At GC - point, the goods and data are checked before the storage goods are moved out of the storage system. At the goods issuing area, the goods are delivered and the shipping units are subsequently formed, packaged, labeled and ready for dispatch. The shelf zone includes the racks and SRV. The compartments are divided into the racks to store goods. SRV runs in the middle of the racks and is controlled from the computer system to receive goods from I-point to the storage compartments or take goods from the storage compartment to deliver to other compartments or to the O-point [2].

The technical components of ASRS contain the storage vehicle, the load handling device, the shelving system, the safety equipment, the fire protection equipment, the conveyors and the controller. The throughput performance of automatic storage systems depends primarily on the dimensions of the rack and the number of the rack aisles, the type and performance of the load handling device, the warehouse operation strategy, the performance and the number of SRVs, the time of processing computer and the controlling cycle.

ASPW are operated by the means of the storage and retrieval cranes or the shuttle systems. It has outstanding advantages such as short accessing time, using space optimization, high-reliability processing with low error rates, high throughput and high energy efficiency. The storage and retrieval machine of the warehouse is the most important part of the system and needs to be analyzed in more detail.

2.3 Storage and retrieval machine in the automatic small parts warehouse

A storage and retrieval machine is a handling and lifting device limited on the rails and it travels within and out of the aisles for the storage and retrieval of unit loads and/or for order picking or similar duties. This machine shall either include lifting means and/or lateral handling facilities. It also includes the transfer equipment for changing between aisles. Control of machines may range from manual to fully automatic [20].

In ASRS, the selected goods are transported from a storage position to a predetermined position or from input point to a storage position. When goods are stored, the information about the goods is recorded. If a goods is transported to another position or taken out, information about this goods is also included [21].

General goals of the optimization of a storage and retrieval system are the utilization of resources and labor force, the avoidance of non-effective time, the minimization of empty moving of SRV, minimization of order processing time, the adherence of given time frames of order processing [22]. The devices used to store and distribute the goods in ASRS are the stacker crane and the shuttle system. Each device has its own characteristics depending on the storage and retrieval requirements of which the device is selected with more remarkable advantages.

Shuttle system is autonomous vehicle in the individual storage levels and is row-rack carrier device. It moves on guide rails along a rack aisle (Fig. 2.4). Depending on the required throughput of the system, it can be fixed on the respective shelf level or used to serve several shelf levels.

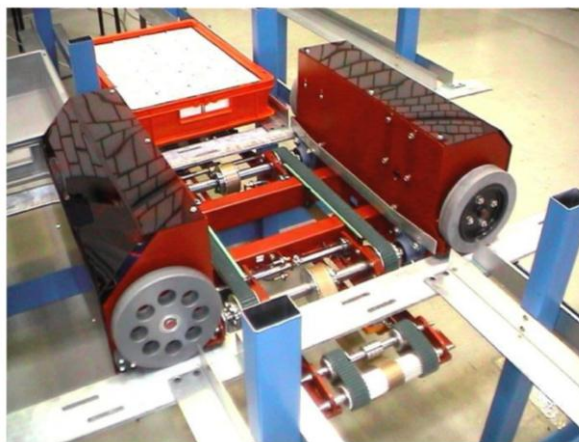

Figure 2.4: Shuttle system [2].

When the throughput is low, a shuttle system is used for some shelf levels. To change the shelf level, the shuttle system moves to the start or end position of the corresponding shelf level and then the vertical conveyor is used to move the shuttle system to another shelf level. When the throughput is high, each shelf level is allocated a shuttle system, which can work independently or together through the vertical conveyor. The vertical conveyor only picks goods up or takes goods out the shelf levels. The shuttle system can pick up, take out and transport a wide variety of ULs by equipping them with different load handling devices (LHDs). The shuttle system is powered by electric motors. The energy supply can be done by integrating on the rails, the batteries or inducting on the rails. The shuttle system is controlled by Wireless Local Area Network (WLAN) [23,24]. The shuttle system has some advantages such as the high throughput, the low floor, the flexibility, the scalability and the modularity. Besides, it has some disadvantages: the investment costs for the rails, the power supply and the safety devices are high; the space requirements for the rails and for the maintenance aisles are wide; the control is complex by many drives, the sensors and the interfaces in the storage system. The shuttle system is not the goal of this study so it is not considered further.

The stacker crane named the storage and retrieval vehicle is a major component of automatic high-bay warehouse and automatic small parts warehouse. It works in three different directions including the movement of the entire vehicle in the x-direction by the driving unit; the movement of the lifting unit along the mast in the y-direction; the extension and the retraction of the load handling device in the z-direction (Fig. 2.5).

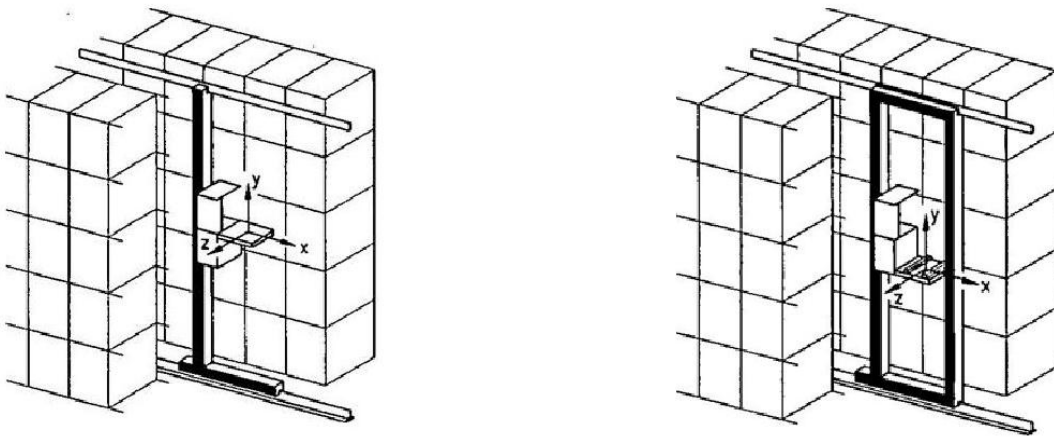

Figure 2.5: Movement directions of a storage and retrieval vehicle [20].

The stacker crane was developed from the rolling ladder and the crane. At the beginning of the sixties, more and more containers were used in production to store the manufacturing parts and to provide the necessary small parts for production. The appropriate container racks were subsequently designed to store the containers. The rolling ladder was used to reach the higher levels. The shelves were required to be larger and higher performance was

necessary to the industry growth. Thus, the first manual stacker crane was developed for container storage. To increase the operational efficiency, the stacker crane was moved on the floor rails and supported by an overhead rail. The containers were increasingly used in other areas, such as the distribution centers or the warehouses. In addition, the storage of cardboard boxes became more important. At that time, the information technology upgraded, the automatic devices increased and the fully automatic storage and retrieval warehouses for the carton boxes were established. Initially, LHDs were designed on the principle of the person-to-goods and the efficiency was not high due to the storage and retrieval time was slow. After that, the principle of the goods-to-person was developed [2].

SRVs are designed to be single mast or twin mast machines. Masts are usually made of box profiles of aluminum or steel but may consist of extruded aluminum profiles as well. Alternatively, a framework structure can be used [20]. To make the device neater and lighter, the twin mast devices are replaced by the single mast devices (Fig. 2.6) and the lightweight aluminum construction of the mast is used. The twin mast devices are only used for big unit loads and the high storage system. In the mid-80s, the online controls were applied to allow order data to be transferred directly to warehouse management and warehouse control [12]. In the past, the storage machine was developed from the crane and then the suspension crane. Due to meet the increasing requirements of the throughput, the stacker crane is designed with high speed and acceleration. The stacker crane is actuated by toothed belts to ensure its high-speed working conditions. In SRV, the driving unit and lifting unit are improved by new control and regulating techniques, which could reduce the working times and increase the better position control. The development of SRV types is shown in Figure 2.7.

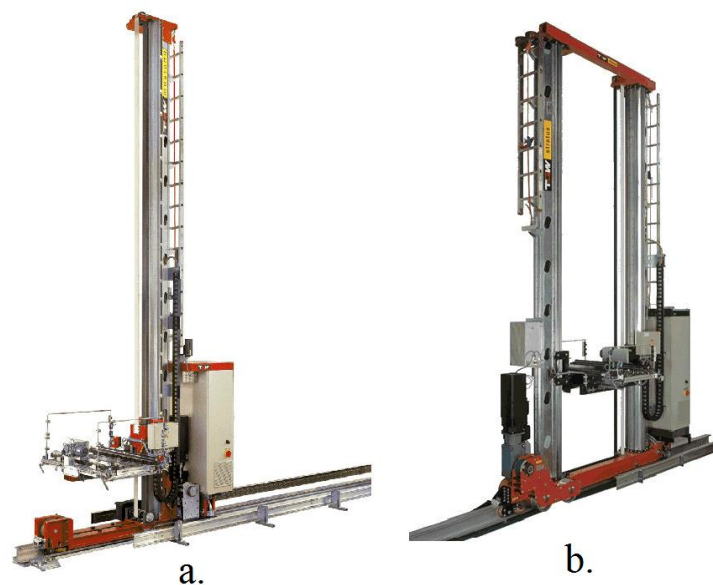

Figure 2.6: Different types of the stacker crane: single mast (a) and twin mast (b) [25].

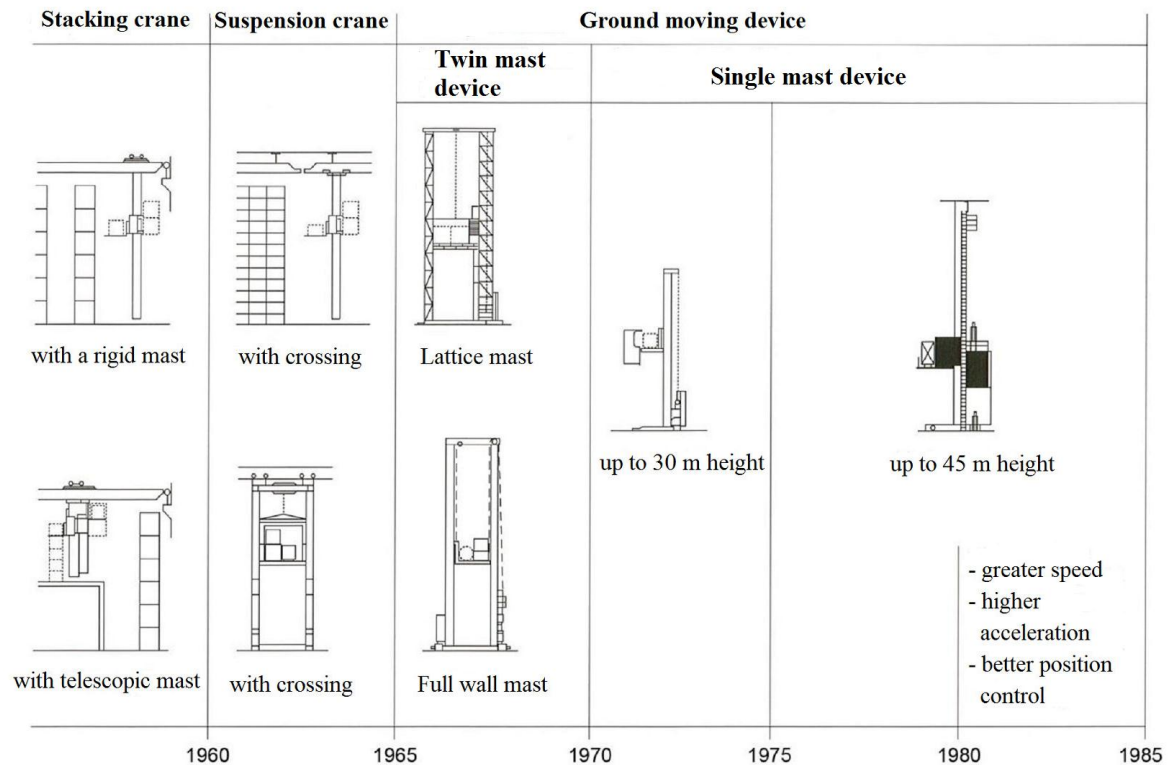

Figure 2.7: Development of the types of stacker cranes [12].

The main components of SRV consist of the driving unit, the lifting unit, the mast, the load handling device, the controller and the energy recovery system (used for modern devices to save the energy) (Fig. 2.8). The mast is fixed to the chassis and holds the lifting unit which moves along the mast. In addition, the top navigating rail is set to prevent the oscillation and the tilting of SRV. The chassis is a frame, which carries the mast as well as all necessary components for a driving of SRV. It includes the driving unit, the driving wheels and the navigating wheels to keep the SRV moving on the rails. The driving unit moves on the rails and adjusts the speed, the acceleration and the movement of SRV along the aisle. A driving unit always consists of driving controller (inverter machine), driving motor, gearbox, mechanical brake, positional control and further application-specific transfer elements. The driving motor of SRV can be a three-phase motor, an asynchronous servo motor or a synchronous servo motor [20,26]. The vehicle can be driven directly by the wheels or the toothed belt. The toothed belt ensures better working conditions when the vehicle moves at high speed and the limited lane length. The lifting unit is driven by a hoist and moved vertically by the mast to lift or lower the goods. There may be one or more LHDs placed on the lifting unit to pick up or take out goods. The control technology is normally connected to the computer via the infrared light barriers in the rack aisle. And then, the vehicle can work automatically to store and distribute goods through the position sensors [2].

- 1 - Top crosshead
- 2 - Mast
- 3 - Braking resistance
- 4 - Cabinet
- 5 - Hoist
- 6 - Three-phase traction drive
- 7 - Driving unit
- 8 - Back wheel
- 9 - Mechanical actuator
- 10 - Load handling device
- 11 - Front wheel
- 12 - Lifting unit

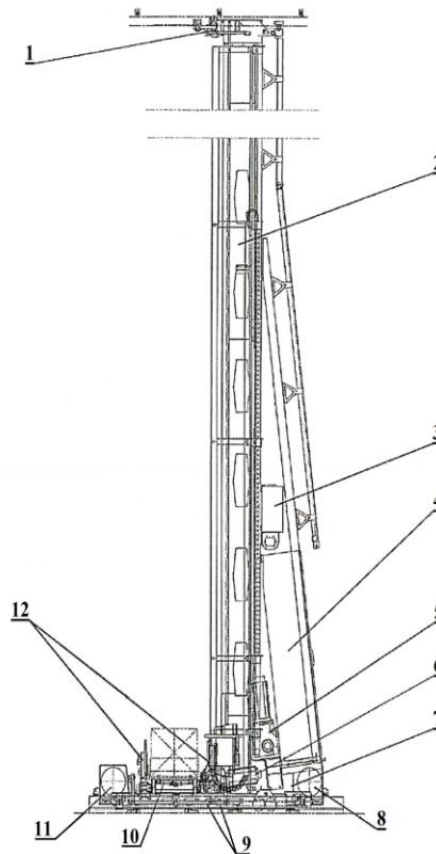

Figure 2.8: Stacker crane (SSI Schäfer).

The energy recovery system includes the regenerative braking, the batteries, the supercapacitor and the buck-boost converter. When the vehicle is acceleration or runs at constant speed, the energy is transferred from the grid power or the battery to the motor. When the vehicle is deceleration or braking, the energy flow is reversed immediately and the motor acts as a generator. The wheels are moved by the potential energy and the experience braking force. The power flows back to the grid power or the battery pack accordingly. Therefore, some portion of energy lost is returned to the grid power or the battery. This system is used more efficiently for short moving distances where brakes are applied frequently. The supercapacitors are significant for two below reasons: Firstly, during braking, they can achieve a big amount of energy in short intervening time and batteries cannot provide; Secondly, during acceleration, there is a significant rise in power demand, the supercapacitor can provide abrupt power which battery cannot provide and the deep charging/discharging cycle of battery causes heating which ultimately reduces the life and the capacity of battery. Supercapacitor has high power density so it can accept/provide big power during braking and acceleration simultaneously [27]. In addition, the energy recovery system is used to reduce the power peak requested by the traction drive [28]. Therefore, the energy recovery system installed on the stacker crane is very reasonable due to the vehicle often moves with short distances and high speeds.

SRV has two main movements: the first movement is its driving unit and the second movement is its lifting unit. These movements, which are driven from the independent motors through the transmission systems, are used by the same control system. SRV is moved in the given orbits (rails). The speeds, positive and negative accelerations and the starting points of the driving unit and the lifting unit can be adjusted independently, depending on the driving and lifting distances to achieve high energy efficiency and to reduce peak load. Another device on SRV is the load handling device, which is put on the lifting unit and used for the storage and retrieval of the unit loads in or out of the position and for the transfer at I/O point. The storage, the retrieval and the transference of SRV are automatically executed and transferred by a control system. It can be operated by the single orders or the sequential orders. In addition, when SRV operates, the energy can be recovered by using the internal energy recovery system or by providing the released energy to the other drives by the direct current intermediate link circuit during braking and lowering processes of SRV.

The control and safety equipment is designed in SRV and in the racks to drive exactly as requirement and to ensure the safety of the system when errors occur during work.

Depending on the goods type and the storage compartment structure, the different LHDs are used to load and unload the ULs such as pulling device, underground telescope, friction belt, gripper (Fig 2.9). The trays, the containers or the cartons can be subsequently pulled/pushed in front of or back to; supported at the bottom or gripped to pick up or take out of the vehicle.

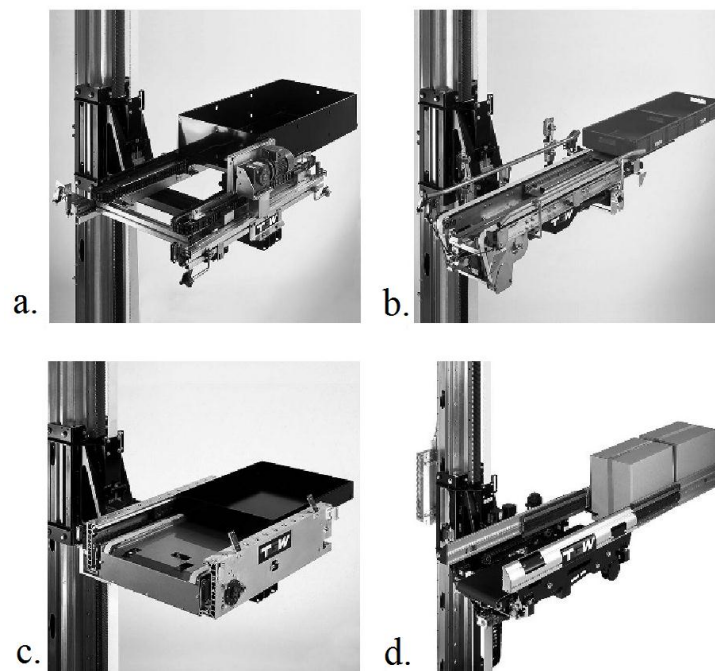

Figure 2.9: LHDs of stacker cranes for handling containers, trays and cardboard
a. pulling device, b. underground telescope, c. friction belt, d. gripper [23].

It is uneconomical for the stacker cranes to be used at the height of upper 15 m [29]. When the storage and retrieval volume is large and the required throughput is small, ASRS can be designed by the different aisles and then SRVs can be automatically changed on the lanes, supported by the curves (Fig. 2.10a) or converters (Fig. 2.10b). The number of rack aisles is larger than the required number of SRVs to increase the SRV's efficiency.

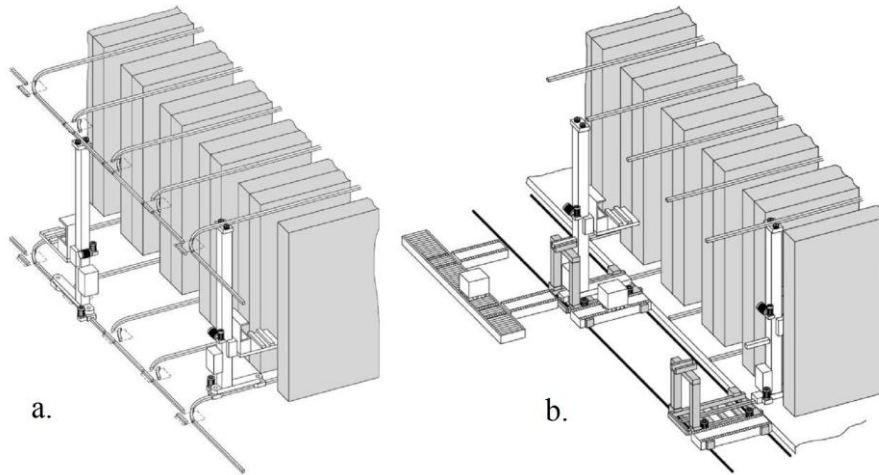

Figure 2.10: Curved stacker cranes (a) and convertible stacker cranes (b) [23].

In order to increase the storage efficiency of SRV in ASRS, several LHDs on the lifting unit, the double deep racks or the double deep lane can be installed by the storage requirements to find out the best one or the combined solution. The reason is that each solution has own advantages and disadvantages, e.g. when the double deep rack is used, the average working time of SRV increases more than the single deep rack in the same moving area due to necessary re-arrangements to store and distribute ULs in the inside compartments. Otherwise, the average moving time to store and distribute UL is reduced by shorter average moving distance and the throughput can be increased by the use of multiple LHDs.

In general, the stacker cranes have some advantages such as high efficiency, LHD installed possibly for up to 6 unit loads, low maintenance, high working availability, big conveyed mass, double and multi-depth storage possibility. Besides, the stacker cranes have some disadvantages as the restriction of very high required throughput rates and big mass; when a stacker crane has a breakdown, the whole alley cannot work.

SRVs are often used in the warehouses with the average throughput and high storage capacity. Furthermore, they are used in warehouses with many different and relatively constant goods, the high requirement of the storage and retrieval efficiency [2]. The SRV technology and control must be developed to reduce the energy need and increase the throughput of ASPW. If the energy efficiency and the throughput of SRVs are improved, many companies will prefer to choose SRVs for the storage and retrieval systems to reduce the operating costs and greenhouse gas emissions.

2.4 Literature review about the throughput and the energy efficiency of automatic small parts warehouse

The throughput and the energy efficiency of ASPW are two important factors affecting the productivity and cost of goods. The control process is logically selected in the storage and retrieval system to increase the competitiveness of the enterprises by reducing the energy consumption and increasing the productivity of the system.

2.4.1 Throughput of the system

The throughput of a system is the rate of the average flow of the transported units per unit of time in the specific conditions. The throughput is calculated from the cycle time. The cycle time of an SRV is the sum total of constant time periods and variable travel periods. These periods depend on the specific technical SRV data and the travel paths in the x, y and z-directions [19]. Improving throughput is the research on the efficient moving time of SRV.

Many studies on the throughput or the moving time of SRV in the storage system have been focused on the establishment of mathematical models to compute the moving time of SRV, e.g. the specific efficiency on the moving time of DOC compared to SOC [30,31]; the moving time of SRV considered in a nondeterministic environment of ASRS [32]. The impact of different operations sequencing strategies on the level of performance was analyzed by using the nearest neighbor sequencing rule; the storage position assignment of each unit load and the interleaving sequencing of the storage and retrieval operations were handled at the same time to minimize the moving time with duration-of-stay based shared storage policy [33]; the routing problem for unit load automated storage and retrieval systems with separate input and output points under the shared storage policy is considered [34]. The resulting problem was formulated as a mixed-integer problem similar for the traveling salesman problem. An exact solution procedure solving a relaxed problem version is also presented and shown to efficiently solve instances of the moving time with up to 400 requests; a static scheduling approach solvable in polynomial time by the transportation problem is treated [35]. They allow the double operation cycles but presuppose that sequence of the storage request is given. Their aim is to minimize the moving time.

Some authors combine both the analytical paradigm and the simulation paradigm by proposing analytical models that help to analyze the moving time of an ASRS prior to a simulation [36]; the analytical model for estimating the moving time of SRV with the closest open location load dispatching is determined [37]. The model is used to calculate the moving time of a random storage system by the demand rate corresponding to the arrival storage and retrieval transactions and the service rate corresponding to load turnover expressed as the expected time; the simulation study of ASRS control policies is

presented to compare several storage assignment policies as well as the sequencing of storage and retrieval requests [38]. The simulation response used in the study is the trade-off between crane moving time and retrieval requests completion time; the moving times of SOC and DOC are considered in several input/output points, in the dwell point strategy and in the physical configuration of the storage system when the random storage is used [39] or evaluated by the effect of multiple dock placement on an ASRS to improve the throughput [40]; the optimal dwell point position of SRV is analyzed in order that after an idle period, the expected travel time to the first operation is minimized [41]. The moving time of SOC is determined when the acceleration and the deceleration are taken into account to resemble the actual move of the vehicle [42] and shown that the proposed travel time model could be useful tools for designing a storage and retrieval system in actual applications.

The average moving time of SRV is calculated in the random storage conditions [43–45]. The advantages of the analytical model (see [43]) consist of the discrete model of the distances to/ between shelves and the I/O point and the good reproduction of the different speed profiles of the SRV. These advantages result in more general validity and a better accuracy. In order to study the performance and accuracy of the suggested analytical model, a simulation was performed [44]. It includes the comparison of the analytical and simulation results and shows minor errors, which confirm the accuracy of the suggested analytical model. This result is interesting for both the design of a system to set up and calculating performances of a currently online system; basing on the result combination of other researchers, the detailed study on a travel time model, which really represents ASRS with all its operational aspects, would be to reduce the travel time and improve the productivity of the system [46].

Travel time analysis of storage and retrieval system for very heavy loads has presented [47]. The advantages of this study include high throughput, high lifting capacity, more flexible rack configuration and high fault tolerance; the travel time of SRV also is considered for double-deep automated storage and retrieval systems [48] or for automated warehouses with aisle transferring storage and retrieval vehicle [49] to improve the productivity of the system; the optimal dimensions of a flow rack automated storage and retrieval system are determined to minimize the expected travel time of SRV [50]; the moving time is considered when the system contains several SRVs and the moving efficiency is determined in the different cases of SRVs [51]; the simulation modeling framework of ASRS is established for the multiple-aisles and the moving time is calculated when the number of the aisles changes. The physical design decisions are therefore based on the operational decisions [52]; sequencing approaches for multiple-aisle automated storage and retrieval systems were shown [53]. The numerical results demonstrate that,

when dealing with random storage, globally sequencing multi-aisle ASRS leads to makespan reductions ranging from 14% to 29% for 2 and 3 aisle systems, respectively.

An optimization method working step-by-step is developed to determine for the minimum travel time of a double operation cycle, when a required goods can be in multiple rack positions and there is a set of empty positions [54]. This method approaches closer to reality due to the previous studies often calculated travel time when the positions of the storage and retrieval goods are known and the sequencing problem consists in determining a route of minimal travel time between these positions.

In today's world of rapidly changing customers' demand, small internet orders, tight delivery schedules, high competition and high service level requirements, it will be increasingly difficult to maintain a good performance when using existing static solution techniques. The research in the field of SRV should now move towards developing models, algorithms and heuristics that include the dynamic and stochastic aspects of current business [55]. The efficiency of the system is increased accordingly.

The above studies have only focused on increasing the productivity of the system and not considered to the energy efficiency that affects directly to the cost of production. The energy efficiency has to be considered simultaneously with the moving time to reduce the cost of goods.

2.4.2 Energy efficiency of the system

Energy efficiency means using less input energy while maintaining an equivalent level of economic activity or service. Besides, the energy need of a system corresponds to the minimum amount of the energy for the system activity. The energy efficiency is a key factor in determining whether a system uses energy properly. The energy efficiency is the goal to reduce the amount of the energy required to provide products and services. Improvements in the energy efficiency are generally achieved by using more efficient technologies or better production processes or by applying the commonly accepted methods to reduce the energy losses.

Energy efficiency is one of the most cost effective ways to enhance security of energy supply, and to reduce emissions of greenhouse gases and other pollutants. In many ways, the energy efficiency can be seen as Europe's biggest energy resource. This is why the Union has set itself a target for 2020 of saving 20% of its primary energy consumption compared to projections, and why this objective was identified in the Commission's Communication on Energy 2020 as a key step towards achieving our long-term energy and climate goals [1].

Since 2002, the national sustainability strategies of the German Federal Government have been issued [56] and one of the areas of special interest is the goal of reducing primary energy use in subsequent years about 20% by 2020 and about 50% by 2050 compared to

2008. Besides, the greenhouse gas emissions are required to reduce about 40% by 2020 and from 80% to 95% by 2050 compared to 1990 [57,58]. This is also a goal to curb global climate change as the earth is gradually warming up. These requirements are in line with the European Union's policies: the target for 2030 is to reduce energy usage at least 27% compared with the business-as-usual scenario and to reduce greenhouse gas emissions about 40% compared to 1990 [59]. In the EU-28 countries in 2015, the structure of the final energy consumption by the sectors showed that the industrial sector is responsible for 25.3% of the total energy consumption [60]. Therefore, it is significant factor which needs to be considered to achieve these targets.

The energy efficiency has a great impact on the economy and it is illustrated in Fig. 2.11. It effectively reduces costs of doing business for some segments of the company [61]. The companies accomplish their goals by immediately increasing the spending on purchases and installation of energy-saving equipment and materials. The long-term realization of the energy-saving goals may translate into a reduction in the spending for purchases of energy and then the product is more competitive in the market.

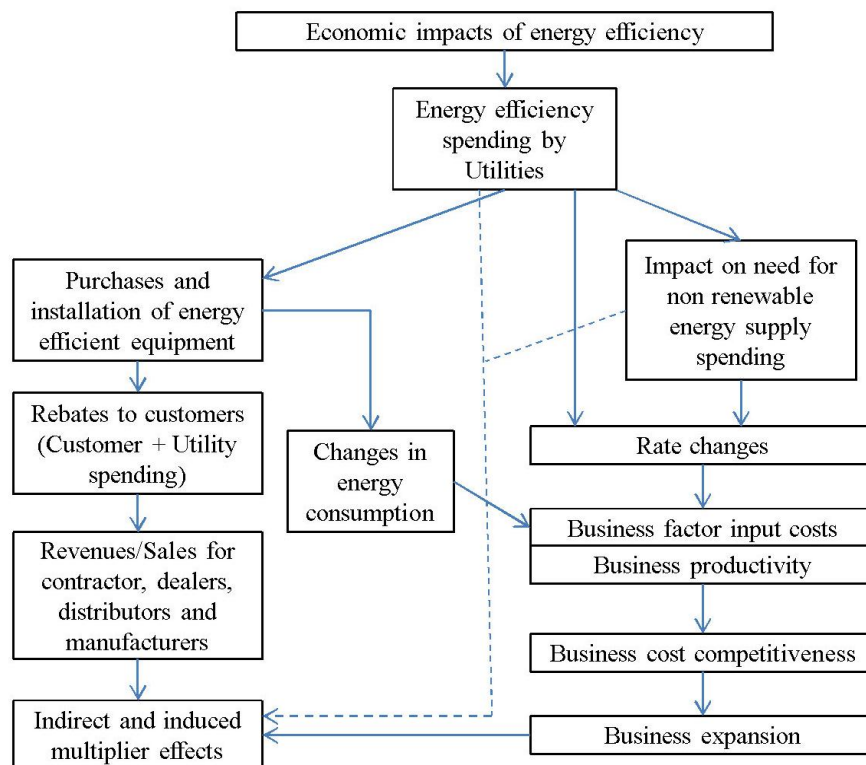

Figure 2.11: Economic impacts of the energy efficiency [61].

The objects of Logistics include the energy need, the goods (materials and products), people, information, material transport means, means of production and infrastructure (buildings, areas and roads) [23]. The energy need in Logistics is subsequently very important to improve both the cost and the greenhouse gas emissions while the logistical performance is maintained. In the past, the work efficiency of the logistics companies was

only considered by costs, time and quality which were reflected in the minimization of throughput time, transport costs or space requirements. Nowadays, they realize the high energy efficiency to be a competitive advantage. Some customers require the logistics service providers to use the energy efficient technologies for the tenders. These can also be seen in Fig. 2.12 which shows the evolution of logistics requirements [62]. The energy efficiency becomes more and more important in logistics due to the improved energy efficiency leads to cost saving or the prices of raw material and energy rise. Thus, the energy efficiency does not affect to product quality of the companies.

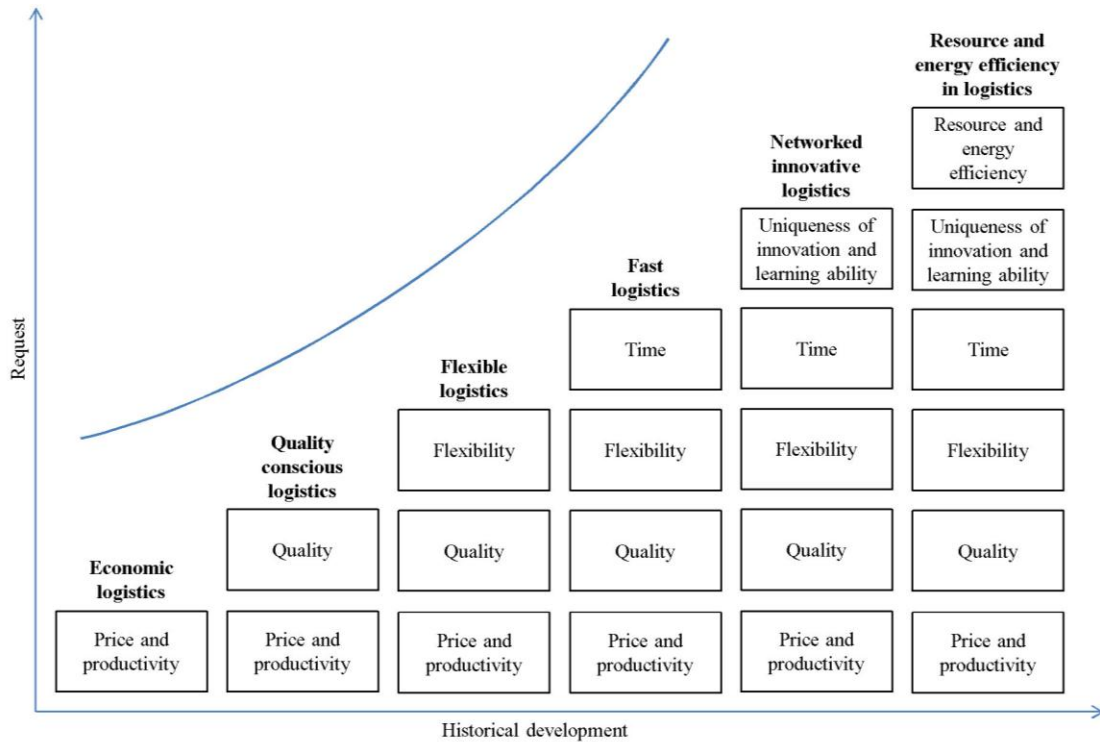

Figure 2.12: The energy efficiency as a new requirement for logistics [62].

Intralogistics is a major part of logistics and the energy consumption in the conveying-, storage and commission technology is very large accounting for 48% of Intralogistics (Fig. 2.1). Therefore, the energy efficiency of ASPW is one of the important factors that should be considered specifically. It impacts on both the cost and the greenhouse gas emissions. In recent years, a large number of the energy efficiency measures including design, technology and control have been subsequently developed in the field of Intralogistics to improve the energy efficiency of the systems. Firstly, the measures of the energy saving in the field of design such as the counterweights usage for stackers, pallet lifters or stacker cranes; the miniaturization of stacker cranes; the lightweight construction and the low rolling friction material combinations between wheel and rail. Secondly, the measures in the field of technology can be the energy efficient drives, the energy recuperation, DC link coupling or the mains feedback. Finally, the measures in the field of control can be the load management, the intelligent distribution of order loads, the necessary rearrangements

during periods of low load, the time-delayed acceleration of stacker cranes, the break time of individual devices/ plant components.

Experts estimate that control measures have greater effects on the energy efficiency than measures in the fields of design and technology. Measures contributing mainly to reduce the energy consumption of SRVs are the low load control and the regenerative power supply. The experts are aware of the further potentialities in the oriented control of Intralogistics systems [2] which is also the subject of the research and analyzed in the following sections.

Processes in Intralogistics can be optimized by the information technology. In general, the improved procedures leads to energy savings, for instance, the relationship between forklift position and material position provides an optimization of the forklift routing or the scenario to remotely monitor by the wireless information technology is proposed for the saving efficiency [63].

Energy efficiency is also affected by the habitual behavior of the worker. Since 2013 to 2016, by implementing a strategy of changing the daily behavior of production workers, a manufacturing plant of Volvo Construction Equipment AB in Sweden reduced its idle electricity spending by 32% and total electricity spending by 14% and its relative idle electricity spending has reached 15% [64].

The absolute energy requirement of a warehouse or a logistics center is influenced by hall size, throughput and automation level. Thus, the absolute total energy demand increases with a higher level of automation or a higher required throughput. On the other hand, the higher the level of automation is, the greater the energy saving potentiality of comparing a standard logistics center with an energy efficient logistics center is [2].

When the energy efficiency measures are implemented in the planning phase, the higher investment costs can be recouped within a few years due to the measures of reducing the energy need during the usage phase. When the energy efficiency methods are applied for a logistics center, the experts estimate the total energy requirement can be reduced up to 65% during the usage phase with the higher investment costs of 10% compared to the total energy requirement of a classic logistics center [2,65]. In this study, the energy efficiency of the storage and retrieval system is analyzed further and then the new methods are shown to reduce the energy need and increase the throughput of the system.

Either technological measures (e.g. reducing friction) or organizational measures (e.g. reducing transport effort or switching off components when they are not currently used) are possible to reduce energy consumption. Technological measures often lead to a change of construction and cause additional costs. Organizational measures are often implemented without additional costs. The main factor to raise the energy efficiency consists of knowledge and model of the relationship between energy consumption and its causes [66].

So far, some studies about the storage and retrieval system consider both of the moving time and energy need to increase their efficiencies, for instance, cycle time and energy need are computed in every position of the system [67], from which the operating process is changed to increase the time efficiency of about 2.52% and the energy saving of 12.66%; the influence of kinematic parameters on the moving time and energy need of SRV [3]; different storage operation strategies are established [2,68] and then the average values of the moving time and energy need are determined when the speed changes, from which the average values are compared to each other to choose a more logical operation strategy. From the simulation results (see [2,68]), the average energy need per unit load of DOC saves about 30% compared to the ones of SOC at all speeds. However, the percentage difference in average throughput increases by decreasing the driving speed (from about 20.5% at 5 m/s to about 36.5% at 1 m/s); the energy is recovered in ASPW to increase the energy efficiency when the driving unit is deceleration or the lifting unit is lower [69]. The energy recovery is determined in some cases of the rack's size and UL to demonstrate the remarkable advantages of the energy recovery system.

Although there have been many studies on the throughput and the energy need of the storage and retrieval systems, they should be considered thoroughly to improve their efficiency in some aspects such as specific relationship between the energy need and the moving time by the simultaneous adjustment of the speed and the acceleration; kinematic parameters needed to adjust in the new measures in the distances for only the startup and braking phases; the logical choice between the storage and retrieval positions in DOC.

In addition, the storage operation strategies, which impact directly to the energy need and the throughput, must be considered in detail to improve the efficiencies of the system. The logical strategy choice depends on the demands of using goods to optimize the efficiencies of the energy need and the throughput.

2.5 Storage operation strategies and the effect of the different operating conditions of the vehicle to the storage and retrieval system

To operate a warehouse as efficiently as possible, the existing storage operation strategies and the different operating conditions of SRV are analyzed specifically [2]. They are summarized and illustrated in Figure 2.13. The storage operation strategies are divided into the storage management strategies and the movement strategies accordingly. The speed and the acceleration, which are two main kinematic parameters of SRV, are considered separately to reduce the energy need and increase the throughput of SRV. The logical choice of the storage operation strategies and the adjustment of the kinematic parameters depend on the layout of the warehouse, the specific storage time of each commodity, the quantity of the goods, the required throughput and the energy need of the system.

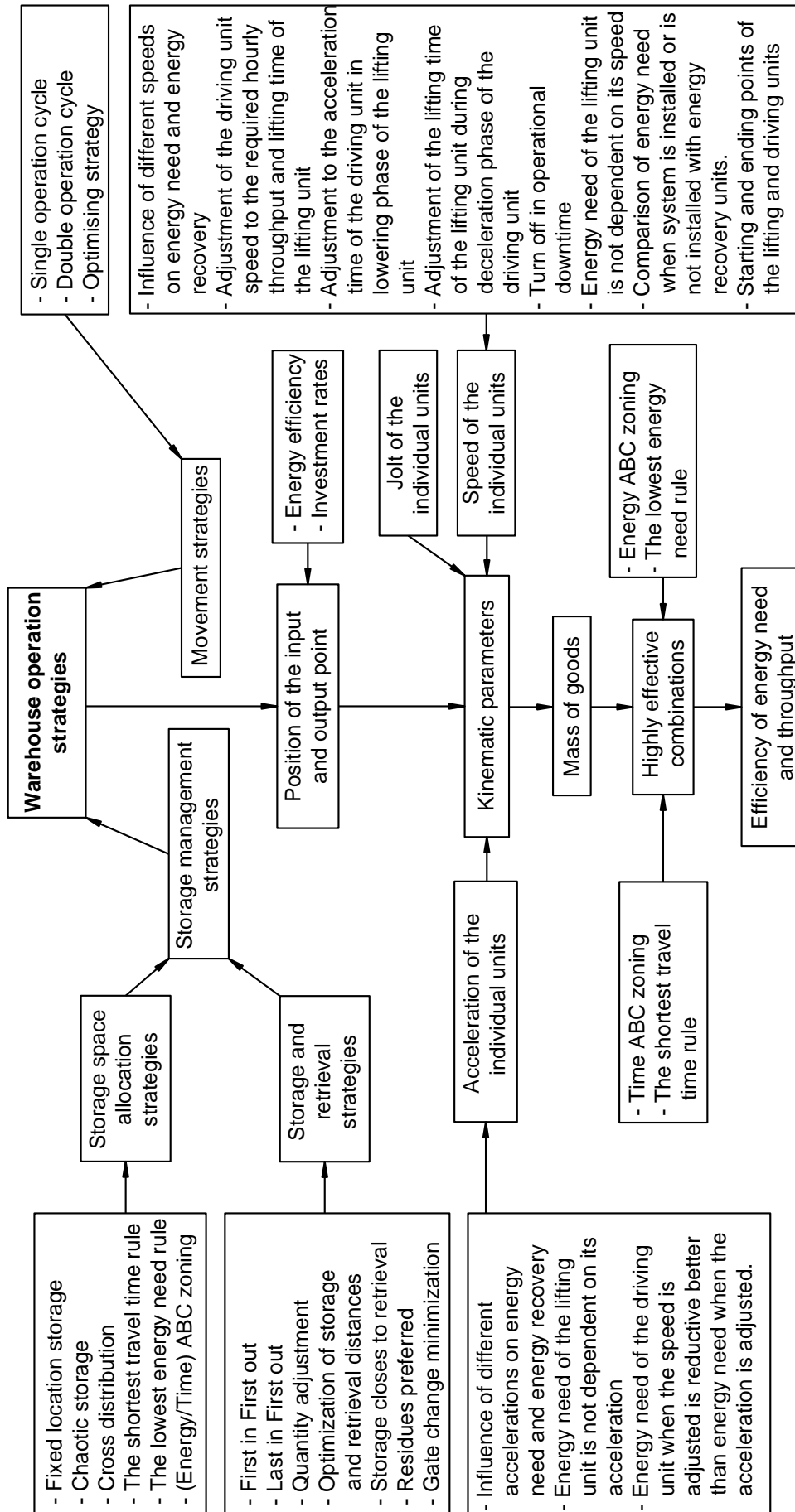

Figure 2.13: Process of selecting the classical warehouse operation strategies and the effect of the different operating conditions of SRV.

2.5.1 Classical warehouse operation strategies

2.5.1.1 Warehouse management strategies

These strategies chosen depend on the requirements of uses, the layout of the system, the choice of the appropriate goods, avoiding the out of date goods, minimizing the moving distance and time of SRV to increase the throughput and reduce the energy need. As a result, the operating costs are reduced and the storage quality is guaranteed.

The warehouse management strategies include the storage space allocation strategies and the storage and retrieval strategies. They are analyzed specifically and have a main influence on the efficiency of the storage compartments [23].

- The storage space allocation strategies are chosen depending on the storage requirements of each goods. These strategies have been analyzed in detail (see [2,7,22,23]) and are summarized in several main points as below:

The fixed location storage is applied when each goods is assigned specifically and the corresponding number of the compartments should be designed for the maximum expected quantity of each goods. These goods are not stored in the location of other goods. This strategy is often applied in manual storage due to be easy to search.

The chaotic storage is applied when each goods can be stored in any free storage space of the system. The storage capacity can be used optimally by this strategy.

The cross distribution is an element of the storage space allocation within fixed areas. This strategy is used when the individual goods are stored in multiple storage aisles, storage areas or storage channels to maximize access capacity and increase warehouse efficiency by processing multiple orders of the same goods simultaneously.

The shortest travel time rule can be combined with some above-mentioned strategies. The storage and retrieval compartments with the lowest movement time are approached. The handling capacity can be increased by minimizing the travel distances. When the compartments are considered for a long time, the compartments closed to the I/O point have a higher storage and retrieval density of ULs.

The lowest energy need rule is applied to the storage and retrieval compartments with the lowest energy need to be approached. It can be combined with some strategies to increase the average energy need and throughput of the system [2].

The storage zone is a mixed element of the fixed location storage and the chaotic storage. The defined goods groups are only stored in free space compartments in fixed storage areas. The purpose of dividing the storage zones of the goods groups is to minimize the average travel distances of SRV or minimize the average energy need. To determine the zones to store goods, the ABC zoning analysis is typically used. Therefore, the corresponding strategy is called the ABC zoning. This strategy is very important for the

further research steps in the following chapters and is analyzed in detail based on the references. The ABC zoning analysis is a method for classifying in three zones (A, B and C) by the importance of the goods based on certain features. The ABC zoning is divided into the time ABC zoning and the energy ABC zoning. When the system is divided into three zones (A, B and C), the required moving time of SRV from the I/O point to the storage and retrieval compartments is from the lowest time to the largest time called the time ABC zoning. The energy ABC zoning is from zone A to zone C and arranged by the requirements from the lowest energy to the highest energy. The ABC zoning is graphically represented [23] as the Lorenz curve (Fig. 2.14).

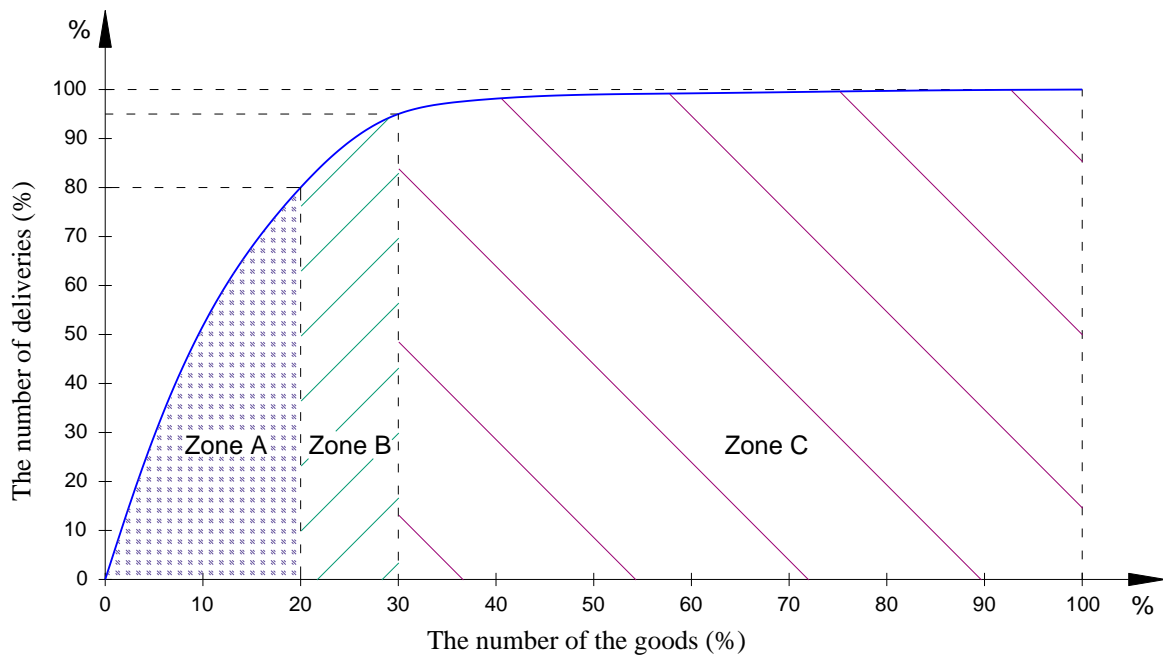

Figure 2.14: The Lorenz curve of the ABC zoning analysis [23].

The boundaries of the classes are defined to assign the goods to different zones. In most companies, few goods (about 10-20%) make up the high traveling density (about 70-80%). This principle is called the Pareto Principle or the rule of 80/20. When the system is divided into three zones (A, B and C), about 20% of the goods often calculated for about 80% of the number of deliveries are stored in the zone A. For zone B, this ratio corresponds to about 10% of the goods for about 15% of the number of deliveries. About 70% of the goods are calculated for about 5% of the number of deliveries called the zone C (Fig 2.14).

If the goods are only assessed by one feature, it won't be enough to decide how to handle them. Therefore, the XYZ analysis is established to assess the goods more clearly. The XYZ analysis is similar to the ABC zoning analysis. The X-goods have a constant access history and thus they have a high prediction accuracy and low access fluctuations. The Y-goods have an average predictive accuracy and have the small fluctuations in demand. The

Z-goods are ordered irregularly with low predictive accuracy. The XYZ classification differs slightly from the ABC analysis, e.g. the X-class is about 10-20% of the goods calculated for approximately 70% of the total access. The Y-class is about 20-40% of the goods calculated for about 20% of the total access. The remainder of the goods (about 40-70%) is determined approximately 10% of the total access and this is the Z-class.

When the ABC and XYZ analysis are merged, a matrix of nine goods classes is created. After that, the specific result and supply strategies of each goods are established [23]. The ABC-XYZ matrix for the feature combination of the access frequency and the prediction accuracy is illustrated in Table 2.1.

		Access frequency		
		A	B	C
Prediction accuracy	X	High access frequency High prediction accuracy	Average access frequency High prediction accuracy	Low access frequency High prediction accuracy
	Y	High access frequency Average prediction accuracy	Average access frequency Average prediction accuracy	Low access frequency Average prediction accuracy
	Z	High access frequency Low prediction accuracy	Average access frequency Low prediction accuracy	Low access frequency Low prediction accuracy

Table 2.1: The ABC-XYZ matrix [23].

In the classical time ABC zoning, the compartments that SRV can move to at the same time are called the isochronal compartments [70]. According to this division, the isochronal compartments depend on the lifting unit speed v_y and driving unit speed v_x . All compartments on the same length l_x and height l_y have the same moving time (Fig. 2.15).

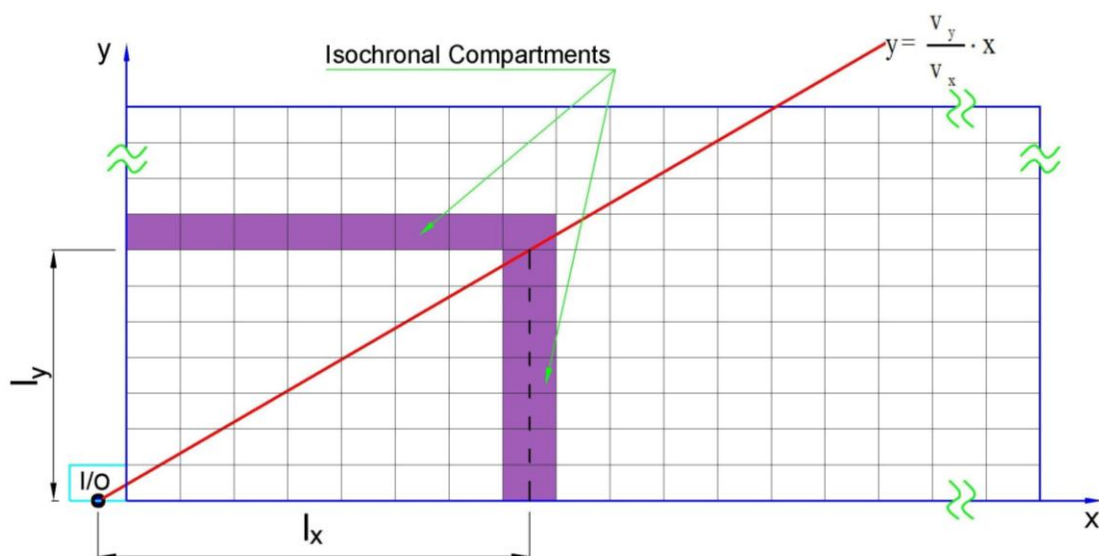

Figure 2.15: Isochronal compartments [2,70,71].

The parameter w is determined by Equation 2.1 [24,70] and used when the system is divided by the time ABC zoning. If $w=1$ and then the kinematic parameters are optimized according to the geometry (the height H and length L) of the system. The description of SRV workspace limit and the zones of the lifting time critical subjects and the driving time critical subjects are illustrated in Figure 2.16.

$$w = \frac{H}{L} \cdot \frac{v_x}{v_y} \quad (2.1)$$

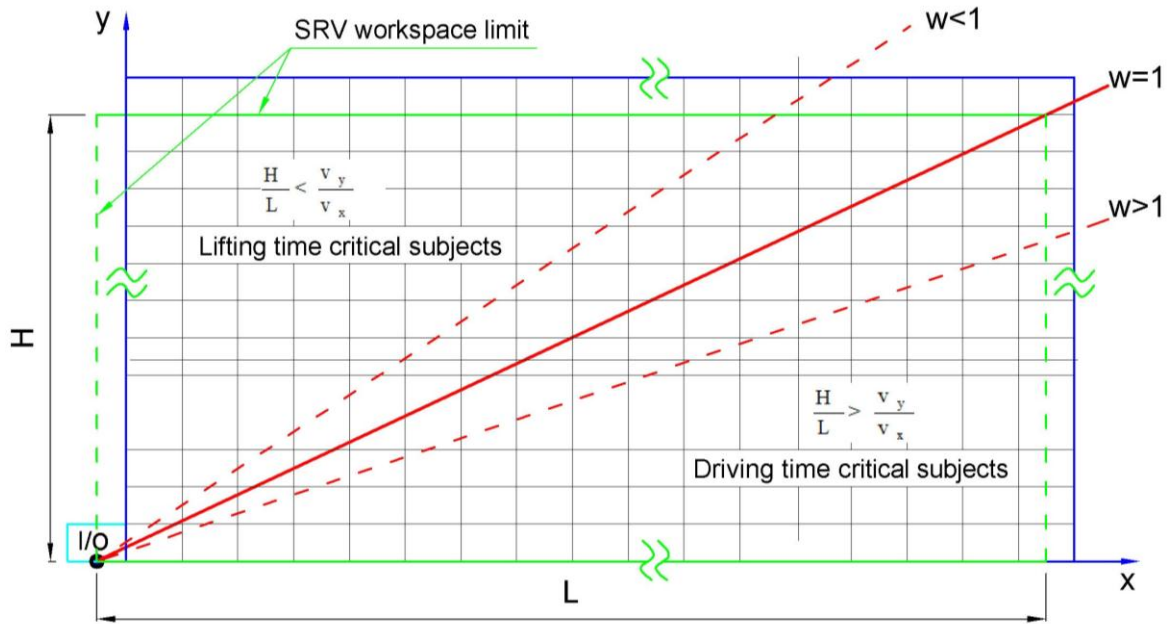

Figure 2.16: Parameters of the rack [2,24,70].

The classical time ABC zoning is determined by the driving unit speed and the lifting unit speed (the acceleration and the jerk of SRV are not considered). Therefore, the isochronal compartments in current practice may be different from the theoretical calculation. The reason is that in the same distances, the moving time in the acceleration and deceleration phases of SRV is changeable when the acceleration and the jerk change.

When the positions of the I/O point are different, the ABC zoning is changeable. The efficiency of the different positions of the I/O point is carefully analyzed [2]. In this study, the I/O point is located in front of the rack at the height of the second row due to its outstanding advantages including practical conditions.

- The storage and retrieval strategies are used to determine which compartments are for the storage and which compartments are for the retrieval in the required time. These strategies are aimed to increase the efficiency of the warehouse. They are analyzed in detail [7,22,72] and are summarized in several main points as below:

First in First out (FIFO) is a commonly used strategy, in which the goods are prioritized for the distribution when they are stored at the earliest time. The advantage of the FIFO

strategy is to avoid obsolescence of the goods, to care about the expiry date of goods and to ensure compliance in a production system.

Last in First out (LIFO) is applied when the last stored goods compared to the others are prioritized for the distribution.

Quantity adjustment is a strategy to adjust the number of the goods according to order requirements. For this strategy, the required number of each goods and the number of the stored goods must be known respectively. Its purpose is to increase throughput by minimizing the re-entry and to improve storage capacity.

Optimization of the storage and retrieval distances is aimed to increase the throughput by minimizing the additional distances. To implement this strategy, the system must always be in control of the storage and retrieval positions (near the I/O point).

Storage closes to retrieval that is a strategy used in DOC to improve its efficiency. To implement this strategy, the distance between the storage and retrieval compartments is chosen as close as possible to minimize the average moving distance.

Residues preferred strategy is used when the total goods with the number of ULs as little as possible are limited to make the most of the storage capacity.

Gate change minimization is used when the relocation order is at first determined by the individual stored aisles in order to minimize time-consuming conversion operations. It minimizes the change in the installation route.

2.5.1.2 Movement strategies

The important movement strategies include the strategies of the single and double operation cycles. Based on the requirements of the throughput and the time of the storage and retrieval, SOC or DOC is performed.

A single operation cycle is required and then SRV carries out two separate processes of the storage and the retrieval. When the storage process is implemented, SRV picks UL up at the transfer point (I/O point), moves it to the storage compartment and stores there and then returns to the transfer point. When the retrieval process is implemented, SRV moves without UL from the transfer point to the retrieval compartment, picks UL up and moves to the transfer point and then takes it out there. In a double operation cycle, SRV executes both storage and retrieval processes in one move. SRV picks UL up at the transfer point, moves it to the storage compartment and stores UL there. On next step, SRV moves without UL to the retrieval compartment, picks UL up there and then moves it to the transfer point and takes UL out. The operating order of the single and double operation cycles of SRV is illustrated in Figure 2.17.

The single and double operation cycles impact to the average throughput and the average energy need of system [2]. In general, all average energy need and average moving time

are saved in the double operation cycles much more than the single operation cycles. In fact, DOC cannot be always executed by SRV due to the goods are sometimes stored only (not distributed) and vice versa. DOC ratio is often below 20% due to the operating requirements of the storage and retrieval system [23]. Therefore, the optimizing operation cycles are analyzed. It is the intelligent storage and retrieval combination of multiple ULs for multiple LHDs. It helps to minimize the average moving distances and the average energy need [2]. The storage vehicles can be equipped with the multiple LHDs to store and distribute the multiple ULs in one move.

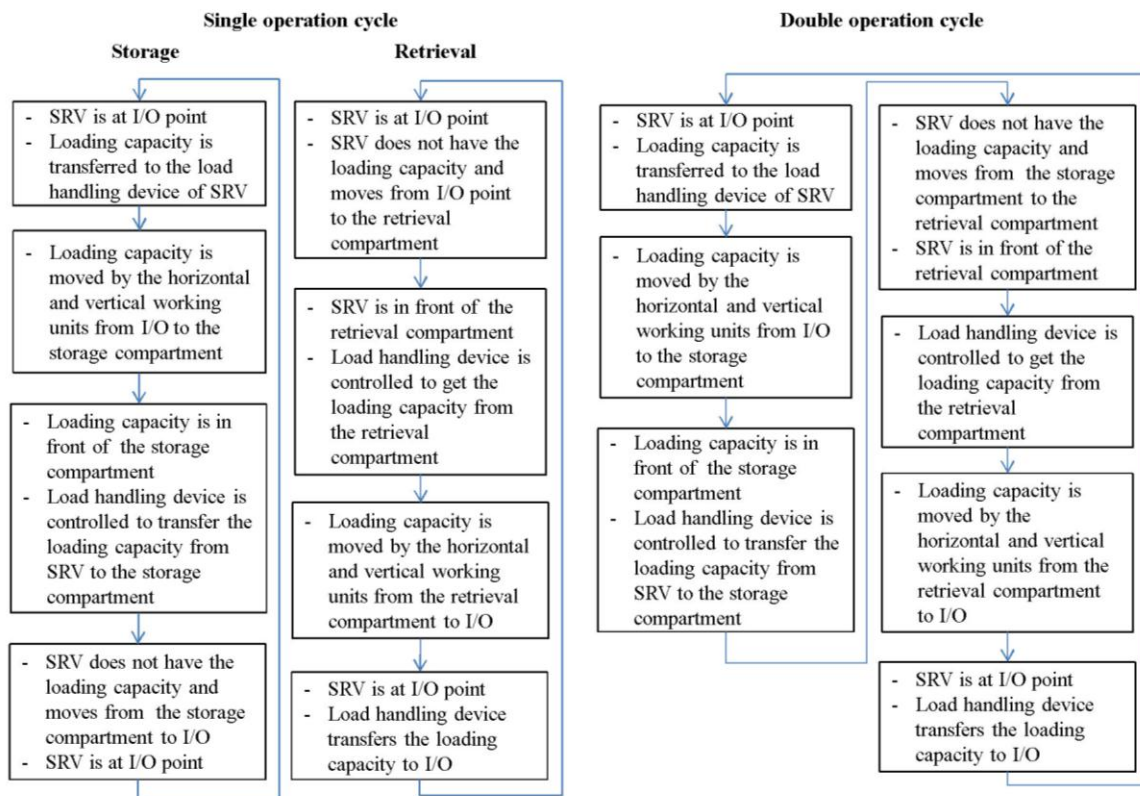

Figure 2.17: The operating order of single and double operation cycles of SRV [2,19].

The re-arrangement strategy also is a movement strategy and used in multi-depth warehouses with the goods-mixed storage compartment allocation. It is often performed in the time period without or with a few orders of the storage and retrieval process. Once the goods are re-arranged more appropriately, the storage and retrieval distances can be shortened and the throughput increases accordingly.

In addition to the above mentioned strategies, others such as the break time position of SRV, the aisles' change, the transfer point and order strategies can be used [17]. However, these strategies are not the subject of this study and not be considered further.

2.5.2 Affecting of the different operating conditions

Further to the storage operation strategies, the different operating conditions also affect significantly to the average throughput and the average energy need of the system. It consists of a number of main factors such as the choice of the input/output point's position, the change in the kinematic parameters of SRV (the distance, the speed, the acceleration and jerk) and the mass of the goods. After that, the highly effective combinations are determined to increase the average throughput and to reduce the average energy need of the system.

2.5.2.1 Input/output point's position

When the input point and the output point are not identical, the efficiency of the throughput is low and the efficiency of the energy need is average [2]. Therefore, the input point and the output point should be selected by the same position (I/O point) to increase the efficiencies of the average throughput and the average energy need.

When the I/O position is changed in the system, the ABC zoning and the efficiencies on the average throughput and the average energy need are also different. The reason is that, in each position, the SRV moves at a certain average distance and its energy recovery capacity is different. To choose the I/O position, it must be based on some criteria, which are the required throughput, the energy efficiency and the investment costs. The effects of the I/O positions on the average throughput and the average energy need per hour are carefully analyzed (see [2]). As the result, two positions are considered. For the first position, the I/O point is located in front of the rack at the height of the second row. For the second position, the I/O point is located in the middle of the rack at the first row. In this study, the I/O point is located in front of the rack at the height of the second row due to it reflects the actual situation of the experimental facilities.

2.5.2.2 Moving distance of the vehicle

For the driving unit, when the vehicle moves in the distances for only the startup and braking phases, the constant speed phase on the way does not appear. The energy recovery rate in the above distances compared with the energy consumption is higher than its rate in the long distances due to the recovery energy is only achieved in the deceleration phase and the energy is consumed in the startup and constant speed phases. When the moving distance of the vehicle is longer than the total distances of the startup and braking phases, the recovered energy is constant. Hence, the long moving distances are not effective due to the energy recovery rate compared with the energy consumption is low.

For the lifting unit, the energy consumption is used when SRV performs the lifting process and the recovery energy is achieved in the lowering process. The energy recovery rate of the lifting unit based on the experimental results is quite high and calculated about 70% of

the energy consumption on every lifting height. Therefore, the efficiencies of the recovery energy of the lifting unit on all heights are the same.

When the driving unit moves in the distances only the startup and braking phases or when the lifting unit lifts/lowers in the height for only the startup and braking phases, the moving time depends mainly on the acceleration of SRV [73]. Therefore, the kinematic parameters should be adjusted in the new measures in these distances to change the moving time and to reduce the energy consumption. This requirement is presented specifically in Chapter 4.

2.5.2.3 *Speed of the vehicle*

For the lifting unit, the energy need of the lifting unit does not depend on the speed and the acceleration [2]. Hence, the speed and the acceleration are only adjusted according to the kinematic parameters of the driving unit to adapt to the required throughput and reduce the peak load and the machine parts' wear.

In general, the lower driving unit speed is, the less energy need is [3]. The driving unit speed depends on the hourly throughput of the goods and therefore, the strategy "*level of the driving unit speed to the required hourly throughput*" is performed [2].

In addition, if the moving time is less than the lifting time, the driving unit speed is adjusted slowly so that all lifting and driving units simultaneously arrive at the destination. The strategy "*level of the driving unit speed at the lifting time*" is therefore developed and calculated [2].

If the driving time is more than the lifting time, the lifting unit speed is adjusted slowly to reduce the peak load and the machine parts' wear due to the energy need does not depend on the lifting unit speed and acceleration.

SRV can get the energy recovery in braking and deceleration process of the driving unit and this energy can be transferred directly to the lifting unit to reduce the peak load so that it is necessary to adjust both the lifting and driving units simultaneously arriving at the destination when SRV performs to lift goods [2,3].

When the lifting unit performs the lowering process, SRV can achieve the energy recovery and this energy can be transferred directly to the driving unit to reduce the peak load. The lowering time of goods is adjusted while the driving unit is in the acceleration phase.

2.5.2.4 *Acceleration of the vehicle*

When the driving unit acceleration is reduced that makes reducing energy need [2,3]. And then the distances of the acceleration and deceleration phases are extended (the distance of the constant speed phase is shortened). Moreover, the peak load also is reduced.

The energy need of the reducing speed is decreased more than the energy need of the reducing acceleration [2]. When the driving and lifting unit acceleration of SRV is small, the machine parts' wear is reduced.

2.5.2.5 *Mass of the goods*

Not only do speed and acceleration affect the energy need of SRV but the goods mass also affects to it and the goods mass does not affect to the throughput of the system. In general, the bigger the goods mass is, the higher the energy need is. The energy recovery also increases when the transported mass increases [2,3]. The energy need and the energy recovery of the lifting unit are more affected by the goods mass than the energy need and the energy recovery of the driving unit due to the mass of SRV is much bigger than the mass of the goods and the mass of the goods usually has a direct impact to the total lifting unit mass. Therefore, the big mass goods can be stored at the positions as low as possible to reduce the energy consumption of the lifting unit. Besides, the storage frame structure also reduces the heavy load on the high.

2.5.2.6 *High effective combinations*

To increase the efficiency of the energy need and the throughput in the process of the system operation, some important combinations defined by some specific strategies are considered including the combination of the time ABC zoning and the shortest travel time rule; the combination of the energy ABC zoning and the lowest energy need rule [2]. When two combinations are compared to each other, the average energy need of the combination of the energy ABC zoning and the lowest energy need rule in every case of the kinematic parameters is less than the average energy need of the combination of the time ABC zoning and the shortest travel time rule. Furthermore, the more the driving unit speed is, the higher the average energy efficiency is and the average throughput of two combinations is not much different [2,68], e.g. when the lifting unit speed is 1.5 m/s and the driving unit speed increases from 2 m/s to 5 m/s, the energy need efficiency percentage of the combination of the energy ABC zoning and the lowest energy need rule increases from 6.35% to 20.08% compared to it of the combination of the time ABC zoning and the shortest travel time rule. However, the average throughput efficiency percentage only changes from +3.74% to -4.76%. These combinations are effectively applied to SOC to increase the throughput and reduce the energy need of the system.

In general, the existing storage operation strategies and the effect of the different operating conditions of SRV to ASRS have shown many effects of increasing the throughput and reducing the energy need during the system operating process. Otherwise, the kinematic parameters of SRV are only studied separately. For the distances for only the startup and braking phases, the kinematic parameters should be adjusted by the new measures to change the moving time and reduce the energy consumption.

Although there have been many studies on the average throughput and the average energy need of the system in the operation cycles, the efficiency of choosing the pairs of the storage and retrieval positions in DOC has not been analyzed in detail to reduce the energy

need and the moving time of SRV. To establish the most appropriate method, some cases of choosing the pairs of the storage and retrieval positions are determined accordingly. The energy need and the moving time in each case are compared to the individual compartments of SOC and compared directly to each other to find the most appropriate choice method for DOC. The following chapters will solve the above requirements to increase the efficiencies of the throughput and the energy need of the system.

Chapter 3

Establishing the mathematical models to determine the storage vehicle parameters in the single operation cycle

In order to make the operation strategies of ASRS more effective in the energy need and the throughput, the mathematical models are established to determine SRV parameters based on the theoretical basis and the experimental results. The automatic small parts warehouse at the Institute of Logistics and Material Handling Systems (ILM) at Otto-von-Guericke University Magdeburg is considered as an example for applying the simulation model. The simulation parameters of SRV are verified by this experimental model.

3.1 Theoretical basis for determining typical parameters of the vehicle

The typical parameters of SRV include the kinematic parameters (speed, acceleration and jerk) and the energy parameters (power and energy need). These parameters are considered in detail as below.

3.1.1 Kinematic parameters

In general, the moving speeds of the driving unit and the lifting unit in some standards and documents [7,19,70] are quite low and impact directly to the horizontal and vertical movement times. The acceleration is therefore assumed to be the constant value for calculating the movement times and the jerk is ignored. In the recent days, the moving speeds of the driving unit and the lifting unit of SRV can achieve to 5 m/s and then the accelerations affect directly to the moving times in the acceleration and deceleration processes of SRV. Especially, when the vehicle moves on the short distance, the startup

and braking distances make up most of the total distance and then the deviations between the theoretical time and the real time are large. The reason is that the jerks limit the change of the acceleration value by the time [74,75]. The real average working time (including the jerk) of SRV in SOC is greater 6% than the theoretical average working time (basing on FEM standard and excluding the jerk) at some given positions of the system [2]. This deviation is not permitted by FEM rule and then the jerk is considered in this research and it is assumed to be constant ($r(t) = r$). After that, the acceleration $a(t)$, the speed $v(t)$ and the distance $s(t)$ of the driving unit and the lifting unit are calculated by the time.

Some general equations to calculate the speed $v(t)$, the acceleration $a(t)$, the jerk $r(t)$ are determined by Equations from 3.1 to 3.3.

$$v(t) = \frac{ds(t)}{dt} \quad (3.1)$$

$$a(t) = \frac{dv(t)}{dt} \quad (3.2)$$

$$r(t) = \frac{da(t)}{dt} = \frac{d^2v(t)}{dt^2} = \frac{d^3s(t)}{dt^3} \quad (3.3)$$

When the jerk is assumed to be constant ($r(t) = r$), the acceleration $a(t)$, the speed $v(t)$ and the distance $s(t)$ are determined by Equation from 3.4 to 3.6 [75,76].

$$a(t) = \int_{t_0}^t r \cdot dt = r \cdot t + a_0 \quad (3.4)$$

$$v(t) = \int_{t_0}^t a \cdot dt = \frac{1}{2} \cdot r \cdot t^2 + a_0 \cdot t + v_0 \quad (3.5)$$

$$s(t) = \int_{t_0}^t v \cdot dt = \frac{1}{6} \cdot r \cdot t^3 + \frac{1}{2} \cdot a_0 \cdot t^2 + v_0 \cdot t + s_0 \quad (3.6)$$

To calculate the kinematic parameters of SRV in the specific phases, the general relationships between the distance s (m), the speed v (m/s), the acceleration a (m/s²) and the jerk r (m/s³) by the time are illustrated in Figure 3.1. For example, the area under the acceleration curve represents the speed at the respective time.

When SRV moves on the general distance and the input parameters (speed, acceleration and jerk) reach the maximum values, the moving process of SRV is divided into seven phases (Fig. 3.1). The acceleration values in the acceleration and deceleration phases can be the same or different and they depends on the operating requirements. Therefore, seven phases are considered individually [2,76]. The phases are calculated in detail from phase 1 to 7 as below:

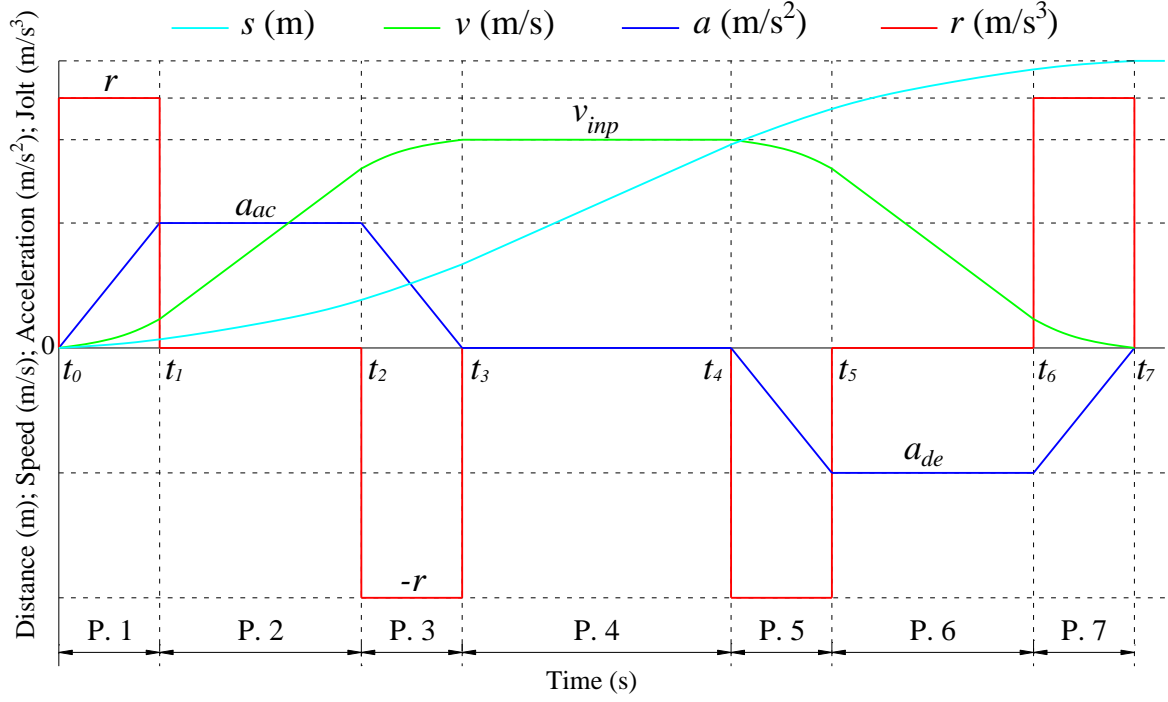

Figure 3.1: General illustration of distance, speed, acceleration and jerk by the time [2].

Phase 1 (P. 1): The movement of SRV is started by this phase. The jerk is a constant positive value and then the linear acceleration increases from $0(\text{m/s}^2)$ to the input value a_{ac} . The acceleration, the speed and the distance in this phase are calculated by Equation (3.7) to (3.9).

$$r(t) = r$$

$$a(t) = \int_{t_0}^t r \cdot dt = r \cdot (t - t_0) + a_0 = r \cdot t \quad (t_0 = 0\text{s and } a_0 = 0\text{m/s}^2) \quad (3.7)$$

$$v(t) = \int_{t_0}^t a \cdot dt = \frac{r}{2} \cdot t^2 + v_0 = \frac{r}{2} \cdot t^2 \quad (v_0 = 0\text{m/s}) \quad (3.8)$$

$$s(t) = \int_{t_0}^t v \cdot dt = \frac{r}{6} \cdot t^3 + s_0 = \frac{r}{6} \cdot t^3 \quad (s_0 = 0\text{m}) \quad (3.9)$$

When $t = t_1$ from Equation (3.7) hence $a_1 = a_{ac} = r \cdot t_1$

$$t_1 = \frac{a_{ac}}{r}$$

$$a_1 = a_{ac} = r \cdot t_1$$

$$v_1 = \frac{1}{2} \cdot r \cdot t_1^2 = \frac{a_{ac} \cdot t_1}{2} = \frac{a_{ac}^2}{2 \cdot r}$$

$$s_1 = \frac{r \cdot t_1^3}{6} = \frac{a_{ac} \cdot t_1^2}{6} = \frac{a_{ac}^3}{6 \cdot r^2}$$

Phase 2 (P. 2): In this phase, the jerk is zero and then the acceleration is constant and equal to the input value a_{ac} . The speed increases with the linear equation. The acceleration, the speed and the distance in this phase are shown by Equation (3.10) to (3.12).

$r(t) = 0$ then:

$$a(t) = \int_{t_1}^t r \cdot dt = r \cdot (t - t_1) + a_1 = a_1 = a_{ac} \quad (3.10)$$

$$v(t) = \int_{t_1}^t a \cdot dt = a_{ac} \cdot (t - t_1) + v_1 = a_{ac} \cdot (t - t_1) + \frac{a_{ac}^2}{2 \cdot r} \quad (3.11)$$

$$s(t) = \int_{t_1}^t v \cdot dt = \frac{a_{ac}}{2} \cdot (t - t_1)^2 + \frac{a_{ac}^2}{2 \cdot r} \cdot (t - t_1) + s_1 = \frac{a_{ac}}{2} \cdot (t - t_1)^2 + \frac{a_{ac}^2}{2 \cdot r} \cdot (t - t_1) + \frac{a_{ac}^3}{6 \cdot r^2} \quad (3.12)$$

When $t = t_2$ hence:

$$a_2 = a_1 = a_{ac}$$

$$v_2 = a_{ac} \cdot (t_2 - t_1) + \frac{a_{ac}^2}{2 \cdot r} \quad (3.13)$$

$$s_2 = \frac{a_{ac}}{2} \cdot (t_2 - t_1)^2 + \frac{a_{ac}^2}{2 \cdot r} \cdot (t_2 - t_1) + \frac{a_{ac}^3}{6 \cdot r^2} \quad (3.14)$$

Phase 3 (P. 3): In this phase, the jerk is a constant negative value and then the linear acceleration decreases from the input value a_{ac} to 0 (m/s²). The speed increases from v_2 to the input value v_{inp} . The acceleration, the speed and the distance in this phase are calculated by Equation (3.15) to (3.17).

$r(t) = -r$ hence:

$$a(t) = \int_{t_2}^t r \cdot dt = -r \cdot (t - t_2) + a_2 = -r \cdot (t - t_2) + a_{ac} \quad (3.15)$$

$$v(t) = \int_{t_2}^t a \cdot dt = -\frac{r}{2} \cdot (t - t_2)^2 + a_{ac} \cdot (t - t_2) + v_2 \quad (3.16)$$

$$s(t) = \int_{t_2}^t v \cdot dt = -\frac{r}{6} \cdot (t - t_2)^3 + \frac{a_{ac}}{2} \cdot (t - t_2)^2 + \left(v_{inp} - \frac{a_{ac}^2}{2 \cdot r} \right) \cdot (t - t_2) + s_2 \quad (3.17)$$

When $t = t_3$ then:

$$a_3 = -r \cdot (t_3 - t_2) + a_{ac} = 0$$

$$t_3 - t_2 = \frac{a_{ac}}{r} = t_1$$

From (3.16):

$$v_3 = v_{inp} = -\frac{r}{2} \cdot (t_3 - t_2)^2 + a_{ac} \cdot (t_3 - t_2) + v_2 = -\frac{r}{2} \cdot \left(\frac{a_{ac}}{r}\right)^2 + a_{ac} \cdot \frac{a_{ac}}{r} + v_2$$

$$v_2 = v_{inp} - \frac{a_{ac}^2}{2 \cdot r}$$

From (3.13):

$$v_2 = a_{ac} \cdot (t_2 - t_1) + \frac{a_{ac}^2}{2 \cdot r} = v_{inp} - \frac{a_{ac}^2}{2 \cdot r}$$

$$t_2 = \frac{1}{a_{ac}} \cdot \left(v_{inp} - \frac{a_{ac}^2}{r} \right) + t_1 = \frac{v_{inp}}{a_{ac}} - \frac{a_{ac}}{r} + \frac{a_{ac}}{r} = \frac{v_{inp}}{a_{ac}}$$

From (3.14):

$$s_2 = \frac{v_{inp}^2}{2 \cdot a_{ac}} - \frac{v_{inp} \cdot a_{ac}}{2 \cdot r} + \frac{a_{ac}^3}{6 \cdot r^2}$$

Therefore:

$$t_3 = \frac{a_{ac}}{r} + t_2 = \frac{a_{ac}}{r} + \frac{v_{inp}}{a_{ac}}$$

$$s_3 = -\frac{r}{6} \cdot (t_3 - t_2)^3 + \frac{a_{ac}}{2} \cdot (t_3 - t_2)^2 + \left(v_{inp} - \frac{a_{ac}^2}{2 \cdot r} \right) \cdot (t_3 - t_2) + s_2 = \frac{v_{inp}^2}{2 \cdot a_{ac}} + \frac{v_{inp} \cdot a_{ac}}{2 \cdot r}$$

Phase 4 (P. 4): In this phase, the jerk and the acceleration are zero and then the speed is constant and equal to the input value v_{inp} . The distance increases with the linear equation.

The acceleration, the speed and the distance in this phase are presented by Equation (3.18) to (3.20).

$$r(t) = 0$$

$$a(t) = \int_{t_3}^t r \cdot dt = r \cdot (t - t_3) + a_3 = a_3 = 0 = a_4 \quad (3.18)$$

$$v(t) = \int_{t_3}^t a \cdot dt = \frac{r}{2} \cdot (t - t_3)^2 + a_3 \cdot (t - t_3) + v_3 = v_3 = v_{inp} = v_4 \quad (3.19)$$

$$s(t) = \int_{t_3}^t v \cdot dt = v_{inp} \cdot (t - t_3) + s_3 = v_{inp} \cdot (t - t_3) + \frac{v_{inp}^2}{2 \cdot a_{ac}} + \frac{v_{inp} \cdot a_{ac}}{2 \cdot r} \quad (3.20)$$

$$t_4 = t_3 + t_{v_const} = \frac{a_{ac}}{r} + \frac{v_{inp}}{a_{ac}} + \frac{s_{v_const}}{v_{inp}}$$

When $t = t_4$ then:

$$s_4 = v_{inp} \cdot (t_4 - t_3) + \frac{v_{inp}^2}{2 \cdot a_{ac}} + \frac{v_{inp} \cdot a_{ac}}{2 \cdot r} = s_{v_const} + \frac{v_{inp}^2}{2 \cdot a_{ac}} + \frac{v_{inp} \cdot a_{ac}}{2 \cdot r}$$

If $a_{ac} = |a_{de}| = a_{inp}$ then:

$$s_4 = v_{inp} \cdot (t_4 - t_3) + \frac{v_{inp}^2}{2 \cdot a_{ac}} + \frac{v_{inp} \cdot a_{ac}}{2 \cdot r} = s_{inp} - s_3 = s_{inp} - \frac{v_{inp}^2}{2 \cdot a_{ac}} - \frac{v_{inp} \cdot a_{ac}}{2 \cdot r}$$

$$t_4 - t_3 = \frac{s_{inp}}{v_{inp}} - \frac{v_{inp}}{a_{ac}} - \frac{a_{ac}}{r} = t_{v_const}$$

$$t_4 = \frac{s_{inp}}{v_{inp}}$$

Phase 5 (P. 5): In this phase, the movement is started to decelerate. The jerk is a constant negative value and then the linear acceleration decreases from $0(\text{m/s}^2)$ to a_{de} . The speed decreases from the input value v_{inp} to v_5 . The acceleration, the speed and the distance in this phase are calculated by Equation (3.21) to (3.23).

$r(t) = -r$ hence:

$$a(t) = \int_{t_4}^t r \cdot dt = -r \cdot (t - t_4) + a_4 = -r \cdot (t - t_4) \quad (3.21)$$

$$v(t) = \int_{t_4}^t a \cdot dt = -\frac{r}{2} \cdot (t - t_4)^2 + v_4 = -\frac{r}{2} \cdot (t - t_4)^2 + v_{inp} \quad (3.22)$$

$$s(t) = \int_{t_4}^t v \cdot dt = -\frac{r}{6} \cdot (t - t_4)^3 + v_{inp} \cdot (t - t_4) + s_4 \quad (3.23)$$

When $t = t_5$ then:

$$a_5 = -r \cdot (t_5 - t_4) = a_{de}$$

$$t_5 - t_4 = -\frac{a_{de}}{r}$$

$$t_5 = t_4 - \frac{a_{de}}{r} = \frac{a_{ac}}{r} + \frac{v_{inp}}{a_{ac}} + \frac{s_{v_const}}{v_{inp}} - \frac{a_{de}}{r}$$

$$v_5 = -\frac{r}{2} \cdot (t_5 - t_4)^2 + v_{inp} = v_{inp} - \frac{a_{de}^2}{2 \cdot r}$$

$$s_5 = -\frac{r}{6} \cdot (t_5 - t_4)^3 + v_{inp} \cdot (t_5 - t_4) + s_4 = \frac{a_{de}^3}{6 \cdot r^2} - \frac{v_{inp} \cdot a_{de}}{r} + s_{v_const} + \frac{v_{inp}^2}{2 \cdot a_{ac}} + \frac{v_{inp} \cdot a_{ac}}{2 \cdot r}$$

If $a_{ac} = |a_{de}| = a_{inp}$ then:

$$t_5 = \frac{2 \cdot a_{ac}}{r} + \frac{v_{inp}}{a_{ac}} + \frac{s_{v_const}}{v_{inp}}$$

$$s_5 = \frac{a_{de}^3}{6 \cdot r^2} - \frac{v_{inp} \cdot a_{de}}{r} + \frac{v_{inp}^2}{2 \cdot a_{de}} + \frac{v_{inp} \cdot a_{de}}{2 \cdot r} = s_{inp} + \frac{a_{de}^3}{6 \cdot r^2} - \frac{v_{inp} \cdot a_{de}}{2 \cdot r} + \frac{v_{inp}^2}{2 \cdot a_{de}}$$

Phase 6 (P. 6): In this phase, the jerk is zero and then the acceleration is a constant negative value and equal to the input negative value a_{de} . The speed decreases with the linear equation. The acceleration, the speed and the distance in this phase are shown by Equation (3.24) to (3.26).

$r(t) = 0$ hence:

$$a(t) = \int_{t_5}^t r \cdot dt = r \cdot (t - t_5) + a_5 = a_5 = a_{de} \quad (3.24)$$

$$v(t) = \int_{t_5}^t a \cdot dt = a_{de} \cdot (t - t_5) + v_5 = a_{de} \cdot (t - t_5) + v_{inp} - \frac{a_{de}^2}{2 \cdot r} \quad (3.25)$$

$$s(t) = \int_{t_5}^t v \cdot dt = \frac{a_{de}}{2} \cdot (t - t_5)^2 + v_5 \cdot (t - t_5) + s_5$$

$$s(t) = \frac{a_{de}}{2} \cdot (t - t_5)^2 + \left(v_{inp} - \frac{a_{de}^2}{2 \cdot r} \right) \cdot (t - t_5) + \frac{a_{de}^3}{6 \cdot r^2} - \frac{v_{inp} \cdot a_{de}}{r} + s_{v_const} + \frac{v_{inp}^2}{2 \cdot a_{ac}} + \frac{v_{inp} \cdot a_{ac}}{2 \cdot r} \quad (3.26)$$

When $t = t_6$ then:

$$v_6 = a_{de} \cdot (t_6 - t_5) + v_{inp} - \frac{a_{de}^2}{2 \cdot r} \quad (3.27)$$

$$s_6 = \frac{a_{de}}{2} \cdot (t_6 - t_5)^2 + \left(v_{inp} - \frac{a_{de}^2}{2 \cdot r} \right) \cdot (t_6 - t_5) + \frac{a_{de}^3}{6 \cdot r^2} - \frac{v_{inp} \cdot a_{de}}{r} + s_{v_const} + \frac{v_{inp}^2}{2 \cdot a_{ac}} + \frac{v_{inp} \cdot a_{ac}}{2 \cdot r} \quad (3.28)$$

Phase 7 (P. 7): The movement is ended by this phase. The jerk is a constant positive value and then the linear acceleration increases from the input negative value a_{de} to $0(\text{m/s}^2)$. The speed decreases from v_6 to 0 m/s . The acceleration, the speed and the distance in this phase are calculated by Equation (3.29) to (3.31).

$r(t) = r$

$$a(t) = \int_{t_6}^t r \cdot dt = r \cdot (t - t_6) + a_6 = r \cdot (t - t_6) + a_{de} \quad (3.29)$$

$$v(t) = \int_{t_6}^t a \cdot dt = \frac{r}{2} \cdot (t - t_6)^2 + a_{de} \cdot (t - t_6) + v_6 \quad (3.30)$$

$$s(t) = \int_{t_6}^t v \cdot dt = \frac{r}{6} \cdot (t - t_6)^3 + \frac{a_{de}}{2} \cdot (t - t_6)^2 + v_6 \cdot (t - t_6) + s_6 \quad (3.31)$$

When $t = t_7$ then:

$$a_7 = r \cdot (t_7 - t_6) + a_{de} = 0$$

$$t_7 - t_6 = -\frac{a_{de}}{r}$$

$$v_7 = \frac{r}{2} \cdot (t_7 - t_6)^2 + a_{de} \cdot (t_7 - t_6) + v_6 = \frac{a_{de}^2}{2 \cdot r} - \frac{a_{de}^2}{r} + v_6 = v_6 - \frac{a_{de}^2}{2 \cdot r} = 0$$

$$v_6 = \frac{a_{de}^2}{2 \cdot r}$$

$$s_7 = \frac{r}{6} \cdot (t_7 - t_6)^3 + \frac{a_{de}}{2} \cdot (t_7 - t_6)^2 + v_6 \cdot (t_7 - t_6) + s_6 = s_{inp}$$

$$s_6 = s_{inp} - \frac{r}{6} \cdot (t_7 - t_6)^3 - \frac{a_{de}}{2} \cdot (t_7 - t_6)^2 - v_6 \cdot (t_7 - t_6)$$

$$s_6 = s_{inp} + \frac{a_{de}^3}{6 \cdot r^2}$$

From (3.27):

$$t_6 - t_5 = \frac{a_{de}}{r} - \frac{v_{inp}}{a_{de}}$$

$$t_6 = \frac{a_{de}}{r} - \frac{v_{inp}}{a_{de}} + t_5 = \frac{v_{inp}}{a_{ac}} + \frac{a_{ac}}{r} + \frac{s_{v_const}}{v_{inp}} - \frac{v_{inp}}{a_{de}}$$

$$t_7 = \frac{v_{inp}}{a_{ac}} + \frac{a_{ac}}{r} + \frac{s_{v_const}}{v_{inp}} - \frac{v_{inp}}{a_{de}} - \frac{a_{de}}{r}$$

If $a_{ac} = |a_{de}| = a_{inp}$ then:

$$t_6 = \frac{2 \cdot v_{inp}}{a_{ac}} + \frac{a_{ac}}{r} + \frac{s_{v_const}}{v_{inp}}$$

$$t_7 = \frac{2 \cdot v_{inp}}{a_{ac}} + \frac{2 \cdot a_{ac}}{r} + \frac{s_{v_const}}{v_{inp}}$$

3.1.2 Power of the motors and energy need of the vehicle

When SRV moves on rails to store and distribute goods, the required power of the motors must be determined at each time to select the appropriate motors and then the energy need can be calculated. The instantaneous power of the motor is determined by the product of the total resistance force and the speed at that time (Eq. (3.32)). The instantaneous energy need is determined by the product of the instantaneous power and the instantaneous time (Eq. (3.33)).

$$P(t) = F(t) \cdot v(t) \quad (3.32)$$

$$dE(t) = P(t) \cdot dt \quad (3.33)$$

SRV includes two main motors of the driving unit and the lifting unit. The resistance forces on each unit are different. The units must be considered separately to determine the required resistance forces accordingly.

- The motor power of the driving unit P_d (W):

When SRV moves on rails with the speed v_d , it is impacted by the total resistance forces F_d . The motor power is presented by Equation (3.34). The required motor power must be greater than the value P_d to ensure SRV movement.

$$P_d = \frac{F_d \cdot v_d}{\eta_t} \quad (3.34)$$

v_d : The speed of the driving unit (m/s)

η_t : The general efficiency (the motor, the inverter machine, the speed reducer, the mechanical actuator, the basic load of the recuperation system, etc.)

F_d : The total resistance force impacting on SRV (N) is determined by Equation (3.35).

When SRV moves on the any position, it is affected by a lot of the resistance forces such as the inertial resistance force, the friction force between the wheel and rail, the friction force in the bearings, the aerodynamic drag force, the resistance force by the rail slope angle, etc. [73]

$$F_d = F_i + F_{f1} + F_w + F_{dw} + F_r + F_{f2} + \sum F_{ext} \quad (3.35)$$

F_i : The inertial resistance force on SRV is calculated by Equation (3.36). It only appears in the acceleration and deceleration phases and depends on the mass of SRV and UL.

$$F_i = m_t \cdot a_d \quad (3.36)$$

m_t : The total mass of SRV and UL (kg)

$$m_t = m_v + m_l \quad (3.37)$$

m_v : The mass of SRV (kg)

m_t : The mass of UL (kg)

a_d : The acceleration of the driving unit (m/s²)

F_{f1} : The friction force between the wheel and the rail and in the bearings are determined by Equation (3.38) [68,77]. This force is always in the opposite direction to motion. The force F_{f1} is determined from the moment equilibrium equation in the wheel axis.

$$F_{f1} = m_t \cdot g \cdot \frac{(2 \cdot f + \mu_r \cdot d)}{D} \quad (3.38)$$

f : The coefficient of the rolling resistance friction between the wheel and the rail

μ_r : The friction coefficient in the bearings is transferred to the gudgeon diameter

d : The diameter of the wheel gudgeon (m)

D : The diameter of the wheel (m)

The coefficients of the rolling resistance friction f and the friction in the bearings μ_r are determined depending on structure of the rails, the diameter of the wheel gudgeon and the diameter of the wheel [77].

F_w : The aerodynamic drag force on a vehicle is presented by Equation (3.39) [78]. It depends on the working place, the shape of the frontal area of SRV (which is SRV area in the traveling direction), the driving unit speed and the wind speed.

$$F_w = \frac{1}{2} \cdot \rho \cdot C_d \cdot A_{ve} \cdot (v_d + v_w)^2 \quad (3.39)$$

ρ : The mass density of air (kg/m³)

C_d : The aerodynamic drag coefficient

A_{ve} : The frontal area of the vehicle

v_d : The driving unit speed

v_w : The longitudinal wind speed

Atmospheric conditions affect air density ρ and hence can significantly affect aerodynamic drag. Besides, it is difficult to determine the aerodynamic drag coefficient. As a result, the aerodynamic drag force on a vehicle is difficult to determine exactly.

F_{dw} : The resistance force by the rail slope angle is showed in Equation (3.40).

$$F_{dw} = k_{ra} \cdot m_t \cdot g \quad (3.40)$$

k_{ra} : The coefficient of the slope angle of the rail. The larger the slope angle of the rail is, the greater the coefficient is.

F_r : The rotative resistance force (N) only appears when SRV moves to another direction.

F_{f2} : The friction force between the rollers and the rails is determined by Equation (3.41).

When SRV moves on the way at any speed, the pressures of the rollers to the rails are different. The pressure of each roller to the rail is also different when the speed changes. Therefore, the friction force between the rollers and the rails is not the same and changes when the speed changes. It means that it is impossible to determine the friction force exactly.

$$F_{f2} = \sum_{j=1}^k \left(F_{srj} \cdot \frac{(2 \cdot f_j + \mu_{rj} \cdot d_j)}{D_j} \right) \quad (3.41)$$

F_{srj} : The force of the rollers to the rails (N)

f_j : The coefficient of rolling resistance friction between roller and rail

μ_{rj} : The coefficient of the friction in the roller's bearings is transferred to the gudgeon diameter

d_j : The diameter of the roller gudgeon (m)

D_j : The diameter of the roller (m)

$\sum F_{ext}$: The other resistance forces such as the friction force by the electricity transmission point, the traction of the cable, etc. (N)

From Equation (3.35) to (3.41), the total resistance force impacting on SRV is determined by Equation (3.42).

$$F_d = m_t \cdot a_d + m_t \cdot g \cdot \frac{(2 \cdot f + \mu_r \cdot d)}{D} + \frac{1}{2} \cdot \rho \cdot C_d \cdot A \cdot (v_d + v_w)^2 \quad (3.42)$$

$$+ k_{ra} \cdot m_t \cdot g + F_r + F_{f2} + \sum F_{ext}$$

- The power of the lifting unit P_l (W):

When the lifting unit lifts or lowers the goods with the speed v_l , it is impacted by the total resistance force F_l . The motor power is presented by Equation (3.43). The required motor power must be greater than the value P_l to ensure the lifting unit movement.

$$P_l = \frac{F_l \cdot v_l}{\eta_l} \quad (3.43)$$

v_l : The speed of the lifting unit (m/s)

η_l : The general efficiency of the lifting unit (the motor, the inverter machine, the speed reducer, the mechanical actuator, the basic load of the recuperation system, etc.)

F_l : The total resistance force impacting on the lifting unit (N) is determined by Equation (3.44). When the lifting unit lifts or lowers the goods on the any position, it is affected by a lot of the resistance forces such as the inertial resistance force, the resistance force of the earth's gravity, the aerodynamic drag force, the friction force by the rollers to navigate the lifting unit, etc.

$$F_l = F_{il} + F_g + \sum_{u=1}^n F_u \quad (3.44)$$

F_{il} : The inertial resistance force on the lifting unit is calculated by Equation (3.45). It only appears in the acceleration and deceleration phases of the lifting unit and depends on the mass of the lifting unit and UL.

$$F_{il} = m_{lm} \cdot a_l \quad (3.45)$$

m_{lm} : The total mass of the lifting unit and UL (kg)

$$m_{lm} = m_{li} + m_l \quad (3.46)$$

m_{li} : The mass of the lifting unit (kg)

m_l : The mass of UL (kg)

a_l : The acceleration of the lifting unit (m/s^2)

F_g : The resistance force of the earth's gravity is calculated by Equation (3.47). This force is in the opposite direction to the movement of the lifting unit when it lifts the goods. When the lifting unit lowers the goods, the resistance force of the earth's gravity is the same direction with movement. It allows the goods to lower themselves without the energy consumption from the motor. And then, the motor transform to a generator from the source of kinetic energy to recover a part of the lost energy in the lifting process.

$$F_g = m_{lm} \cdot g \quad (3.47)$$

$\sum_{u=1}^n F_u$: The other resistance forces such as the friction force by the rollers to navigate the lifting unit, the aerodynamic drag force, the electricity transmission point, the traction of the cable, etc.

From Equation (3.44) to (3.47), the total resistance force impacting on the lifting unit is determined by Equation (3.48).

$$F_l = m_{lm} \cdot a_l + m_{lm} \cdot g + \sum_{u=1}^n F_u \quad (3.48)$$

- Simplify the formulas for calculating the motor power of the movement units

The theoretical formulas to calculate the consumption powers are complex and difficult to determine exactly some resistance forces (the aerodynamic drag force, the friction force between the rollers and the rails, the resistance force by the slope angle of the rail, the general efficiency, etc.). Therefore, these formulas must be simplified when the simulation model is established. The complex resistance forces are replaced by the coefficients, which are achieved by the experimental results. The motor power of the driving unit is determined by Equation (3.49) and the motor power of the lifting unit is determined by Equation (3.50).

$$P_d = \left(m_t \cdot a_d + m_t \cdot g \cdot \frac{(2 \cdot f + \mu_r \cdot d)}{D} \right) \cdot v_d \cdot K_t \quad (3.49)$$

$$P_l = m_{lm} \cdot (a_l + g) \cdot v_l \cdot K_l \quad (3.50)$$

The coefficients K_t of the driving unit and K_l of the lifting unit are achieved by the experimental results. When the storage and retrieval system is different, the coefficients are also different. In a system, the coefficients can also change by the time due to the general efficiency of the system changes by the time. Therefore, for a certain period of time, these parameters need to be re-checked accurately. If the error is above 5%, they must be redefined. The main purpose of this study is to establish a model that simulates the same parameters as the actual model to find the optimal efficiency strategy of the energy need and the throughput and then the change of coefficients by the time is not further explored.

3.2 Analyzing the working cases of the vehicle according to kinematic parameters

Based on controlling of each unit, when SRV moves on rails, the acceleration values in the acceleration and deceleration phases are quantitatively identical or not. Therefore, they are distinguished separately and the working case of each unit depends on the specific kinematic parameters when they reach the input values or not. The movement time of each unit can be calculated by the derived equations of motion. The detailed analyzations of these cases are presented as below:

3.2.1 When acceleration values in the acceleration and deceleration phases are quantitatively identical

When the acceleration values in the acceleration and deceleration phases are quantitatively identical $a_{ac} = |a_{de}| = a_{inp}$, the four working cases of SRV are distinguished (Fig. 3.2) depending on the value of the moving distance (s_{inp}), the input speed (v_{inp}) and the input acceleration (a_{inp}) [2]. In the acceleration and deceleration phases, the speed curve is simplified and the speed changes are assumed to be linear. The final results are not affected due to the areas under the speed curves are equal (Fig. 3.3).

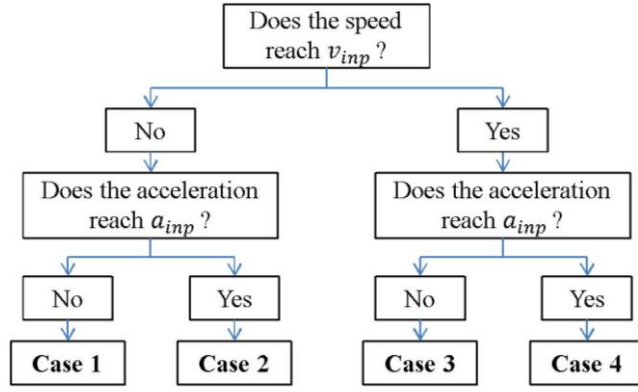

Figure 3.2: Differentiation of movement cases with identical magnitude of acceleration values [2].

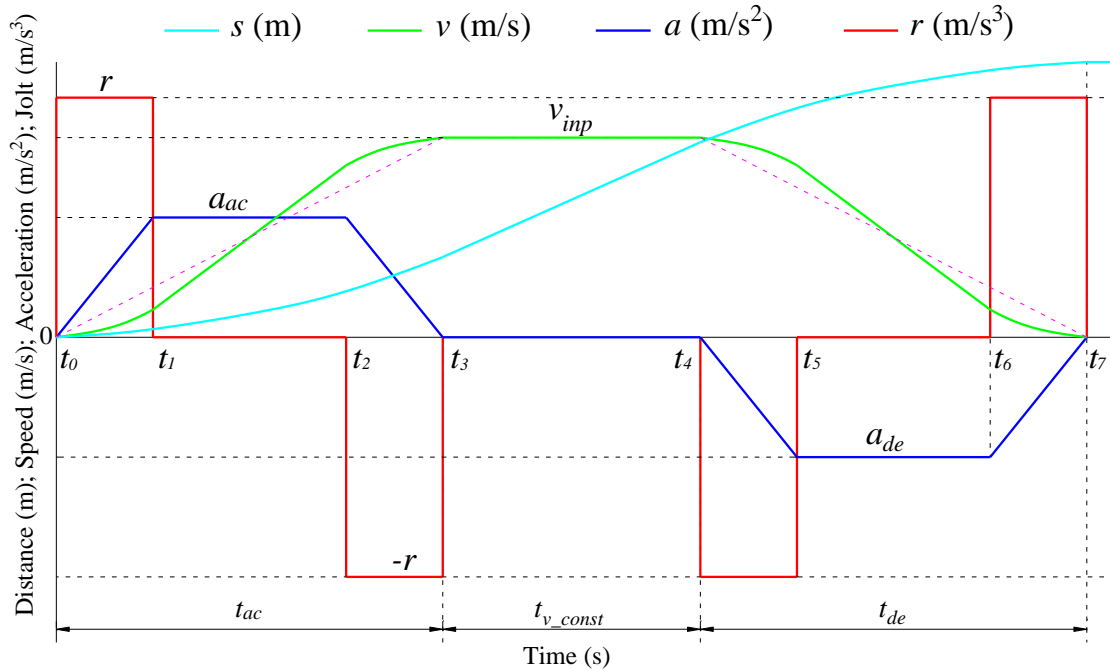

Figure 3.3: The simplification of the speed curves in the acceleration and deceleration phases [2].

Case 1: Both of the speed and the acceleration do not reach to the input values (Fig. 3.4). In this case, the vehicle moves in the short distance, the achieved speed $v_{achi} < v_{inp}$ and the achieved acceleration $a_{achi} < a_{ac} = a_{inp}$.

The achieved acceleration and the achieved speed depend on the acceleration or deceleration time (Eq. (3.51) and Eq. (3.53)).

$$a_{achi} = \frac{r}{2} \cdot t_{ac} = \frac{r}{2} \cdot t_{de} \quad (3.51)$$

$$t_{ac} = t_{de} = \frac{2 \cdot a_{achi}}{r} \quad (3.52)$$

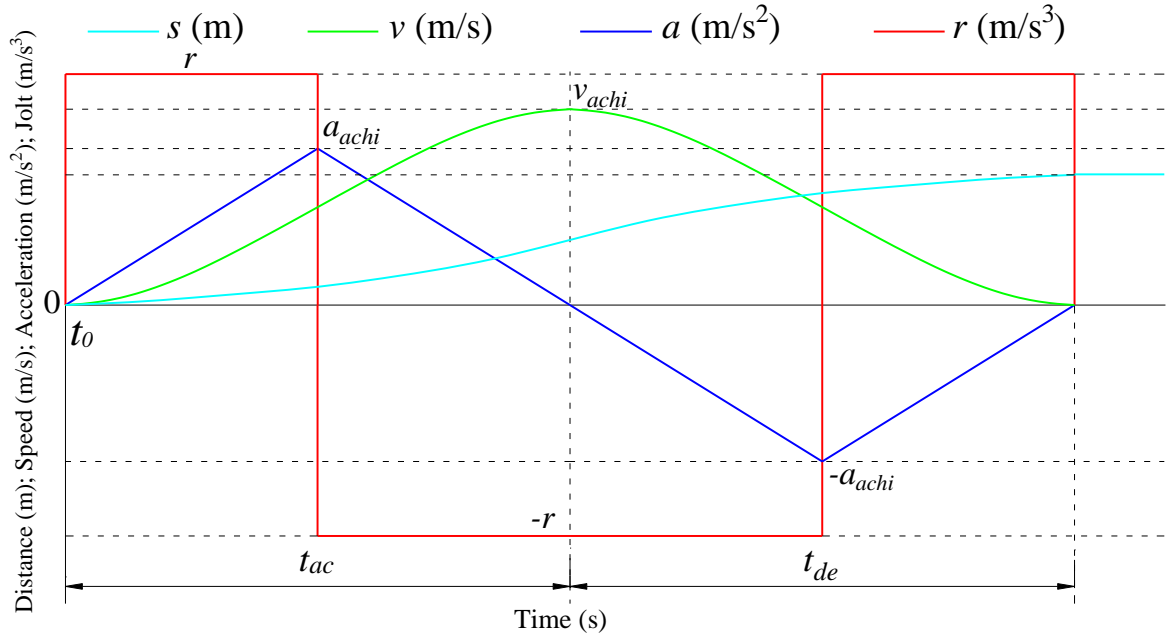

Figure 3.4: Example of movement curves when the speed and the acceleration do not reach the input values [2].

$$v_{achi} = \frac{a_{achi}}{2} \cdot t_{ac} = \frac{r}{4} \cdot t_{ac}^2 \quad (3.53)$$

The speed changes in the acceleration and deceleration phases are assumed to be linear and then from Fig. 3.4 the acceleration and deceleration distances are the same and calculated by Equation (3.54).

$$s_{ac} = s_{de} = \frac{v_{achi}}{2} \cdot t_{ac} = \frac{r}{8} \cdot t_{ac}^3 = \frac{v_{achi} \cdot a_{achi}}{r} = \frac{s_{inp}}{2} \quad (3.54)$$

From Equation (3.54), the acceleration time t_{ac} and the deceleration time t_{de} can be shown by Equation (3.55). When the distance and the jerk are determined and from Equations (3.53) and (3.55), the achieved speed is presented by Equation (3.56). From Equations (3.51) and (3.55), the achieved acceleration is pointed out by Equation (3.57) accordingly. In this case, the total movement time t_{tot} only depends on the input distance and the jerk and then determined by Equation (3.58).

$$t_{ac} = t_{de} = \sqrt[3]{\frac{4 \cdot s_{inp}}{r}} \quad (3.55)$$

$$v_{achi} = \frac{r}{4} \cdot \left(\frac{4 \cdot s_{inp}}{r} \right)^{\frac{2}{3}} \quad (3.56)$$

$$a_{achi} = \frac{r}{2} \cdot t_{ac} = \frac{r}{2} \cdot \sqrt[3]{\frac{4 \cdot s_{inp}}{r}} \quad (3.57)$$

$$t_{tot} = t_{ac} + t_{de} = 2 \cdot \sqrt[3]{\frac{4 \cdot s_{inp}}{r}} \quad (3.58)$$

The condition for this case is $v_{achi} < v_{inp}$ and $a_{achi} < a_{ac} = a_{inp}$. From Equation (3.57), the condition to $a_{achi} < a_{ac} = a_{inp}$ is determined by Equation (3.59) and from Equation (3.56), the condition to $v_{achi} < v_{inp}$ is determined by Equation (3.60).

When $a_{achi} < a_{ac} = a_{inp}$ then

$$a_{achi} = \frac{r}{2} \cdot t_{ac} = \frac{r}{2} \cdot \sqrt[3]{\frac{4 \cdot s_{inp}}{r}} < a_{inp}$$

$$\frac{r}{4} \cdot \left(\frac{4 \cdot s_{inp}}{r} \right)^{\frac{2}{3}} < \frac{a_{inp}^2}{r} \quad (3.59)$$

When $v_{achi} < v_{inp}$ then

$$v_{achi} = \frac{r}{4} \cdot \left(\frac{4 \cdot s_{inp}}{r} \right)^{\frac{2}{3}} < v_{inp} \quad (3.60)$$

From Equations (3.59) and (3.60), the condition for $v_{achi} < v_{inp}$ and $a_{achi} < a_{inp}$ is shown by system of inequalities (3.61)

$$\begin{cases} v_{achi} = \frac{r}{4} \cdot \left(\frac{4 \cdot s_{inp}}{r} \right)^{\frac{2}{3}} < v_{inp} \\ \frac{r}{4} \cdot \left(\frac{4 \cdot s_{inp}}{r} \right)^{\frac{2}{3}} < \frac{a_{inp}^2}{r} \end{cases} \quad (3.61)$$

The smaller value in the two values v_{inp} and $\frac{a_{inp}^2}{r}$ is selected to satisfy this case.

Case 2: The speed does not reach to v_{inp} and the acceleration achieves a_{inp} (Fig. 3.5). In this case, SRV moves in the short distance or the acceleration is quite small and then SRV is not enough time to reach input speed. It means that $v_{achi} < v_{inp}$ and $a_{achi} = a_{ac}$.

The acceleration distance is calculated similarly to Phase 3 Section 3.1.1. The accelerations in the acceleration and deceleration phases are quantitatively identical and then the acceleration and deceleration distances are also identical and equal to a half of the total distance (Eq. 3.62). The achieved speed can be determined by solving the quadratic equation (3.63).

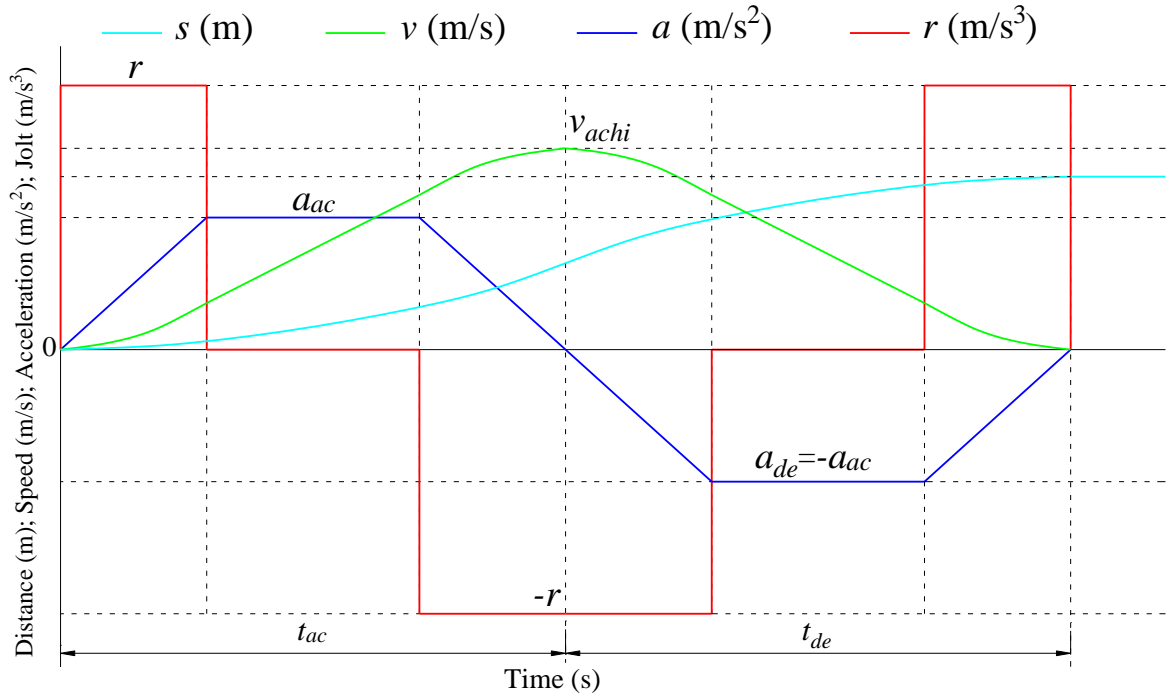

Figure 3.5: Example of movement curves when the speed does not reach the input speed and the acceleration reaches the input acceleration [2].

$$s_{ac} = s_{de} = \frac{s_{inp}}{2} \quad (3.62)$$

$$s_{ac} = \frac{v_{achi}^2}{2 \cdot a_{ac}} + \frac{v_{achi} \cdot a_{ac}}{2 \cdot r}$$

$$v_{achi}^2 + \frac{a_{ac}^2}{r} \cdot v_{achi} - 2 \cdot a_{ac} \cdot s_{ac} = 0 \quad (3.63)$$

The quadratic equation (3.63) has two solutions shown by Equation (3.64)

$$v_{achi1,2} = -\frac{a_{ac}^2}{2 \cdot r} \pm \sqrt{\left(\frac{a_{ac}^2}{2 \cdot r}\right)^2 + 2 \cdot a_{ac} \cdot s_{ac}} \quad (3.64)$$

The speed v_{achi} is negative so Equation (3.63) has only one positive solution satisfying the actual conditions:

$$v_{achi} = -\frac{1}{2} \cdot \frac{a_{ac}^2}{r} + \sqrt{\left(\frac{a_{ac}^2}{2 \cdot r}\right)^2 + a_{ac} \cdot s_{inp}} \quad (3.65)$$

The speed changes in the acceleration and deceleration phases are assumed to be linear (Figure 3.3) and then the acceleration and deceleration distances are calculated by Equation (3.66). The acceleration and deceleration times are shown by Equation (3.67).

$$s_{ac} = s_{de} = \frac{s_{inp}}{2} = \frac{v_{achi}}{2} \cdot t_{ac} \quad (3.66)$$

$$t_{ac} = t_{de} = \frac{s_{inp}}{v_{achi}} = \frac{v_{achi}}{a_{ac}} + \frac{a_{ac}}{r} = \frac{t_{tot}}{2} \quad (3.67)$$

From the condition $a_{achi} = a_{ac}$, it is equivalent to $t_{ac} - t_1 \geq t_1$ then

$$\frac{v_{achi}}{a_{ac}} + \frac{a_{ac}}{r} - \frac{a_{ac}}{r} \geq \frac{a_{ac}}{r}$$

$$v_{achi} \geq \frac{a_{ac}^2}{r} \quad (3.68)$$

When $v_{achi} < v_{inp}$ then

$$v_{achi} = -\frac{1}{2} \cdot \frac{a_{ac}^2}{r} + \sqrt{\left(\frac{a_{ac}^2}{2 \cdot r}\right)^2 + a_{ac} \cdot s_{inp}} < v_{inp}$$

$$\left(\frac{a_{ac}^2}{2 \cdot r}\right)^2 + a_{ac} \cdot s_{inp} < v_{inp}^2 + \frac{v_{inp} \cdot a_{ac}^2}{r} + \left(\frac{a_{ac}^2}{2 \cdot r}\right)^2$$

$$\frac{s_{inp}}{v_{inp}} - \frac{v_{inp}}{a_{ac}} - \frac{a_{ac}}{r} < 0 \quad (3.69)$$

From Equations (3.68) and (3.69), the condition for $v_{achi} < v_{inp}$ and $a_{achi} = a_{ac}$ is determined by system of inequality (3.70).

$$\begin{cases} \frac{s_{inp}}{v_{inp}} - \frac{v_{inp}}{a_{inp}} - \frac{a_{inp}}{r} < 0 \\ v_{achi} = -\frac{1}{2} \cdot \frac{a_{inp}^2}{r} + \sqrt{\left(\frac{a_{inp}^2}{2 \cdot r}\right)^2 + a_{inp} \cdot s_{inp}} \geq \frac{a_{inp}^2}{r} \end{cases} \quad (3.70)$$

Case 3: The acceleration does not reach to a_{inp} and the speed achieves v_{inp} (Fig. 3.6). In this case, the acceleration is big and the speed is quite small and then the acceleration does not achieve the input value and the speed reaches input value. It means that $v_{achi} = v_{inp}$ and $a_{achi} < a_{ac} = a_{inp}$.

The acceleration and deceleration times are determined by Equation (3.71). When the input speed is reached, it is determined by Equation (3.72). The achieved acceleration is shown by Equation (3.73) respectively. From Equations (3.71) and (3.73), the acceleration and deceleration times are presented by Equation (3.74).

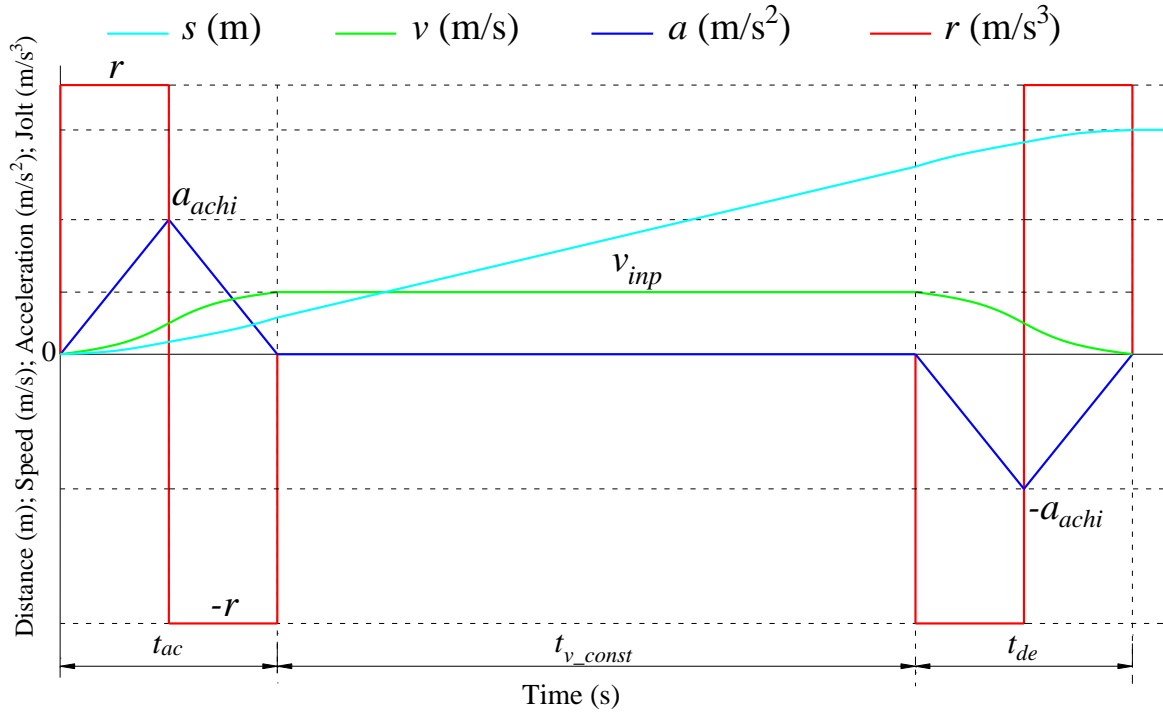

Figure 3.6: Example of movement curves when the speed is reached the input speed and the acceleration does not reach the input acceleration [2].

$$t_{ac} = t_{de} = 2 \cdot \frac{a_{achi}}{r} \quad (3.71)$$

$$v_{achi} = v_{inp} = \frac{a_{achi}}{2} \cdot t_{ac} = \frac{a_{achi}}{2} \cdot 2 \cdot \frac{a_{achi}}{r} = \frac{a_{achi}^2}{r} \quad (3.72)$$

$$a_{achi} = \sqrt{v_{inp} \cdot r} \quad (3.73)$$

$$t_{ac} = t_{de} = 2 \cdot \sqrt{\frac{v_{inp}}{r}} \quad (3.74)$$

The speed changes in the acceleration and deceleration phases are assumed to be linear and then the acceleration and deceleration distances are calculated by Equation (3.75). The distance of the constant speed is presented by Equation (3.76) and the time of this distance is shown by Equation (3.77). The total movement time is determined by Equation (3.78).

$$s_{ac} = s_{de} = \frac{v_{inp}}{2} \cdot t_{ac} = \frac{v_{inp}}{2} \cdot 2 \cdot \frac{a_{achi}}{r} = \frac{v_{inp} \cdot a_{achi}}{r} = \sqrt{\frac{v_{inp}^3}{r}} \quad (3.75)$$

$$s_{v_const} = s_{inp} - s_{ac} - s_{de} = s_{inp} - 2 \cdot \sqrt{\frac{v_{inp}^3}{r}} \quad (3.76)$$

$$t_{v_const} = \frac{s_{v_const}}{v_{inp}} = \frac{s_{inp}}{v_{inp}} - 2 \cdot \sqrt{\frac{v_{inp}}{r}} \quad (3.77)$$

$$t_{tot} = t_{ac} + t_{v_const} + t_{de} = \frac{s_{inp}}{v_{inp}} + 2 \cdot \sqrt{\frac{v_{inp}}{r}} \quad (3.78)$$

From the condition $a_{achi} < a_{ac} = a_{inp}$ and Equation (3.73) then

$$\begin{aligned} a_{achi} &= \sqrt{v_{inp} \cdot r} < a_{inp} \\ v_{inp} &< \frac{a_{inp}^2}{r} \end{aligned} \quad (3.79)$$

To $v_{achi} = v_{inp}$ it means that $t_{v_const} \geq 0$ then

$$\frac{s_{inp}}{v_{inp}} - 2 \cdot \sqrt{\frac{v_{inp}}{r}} \geq 0 \quad (3.80)$$

From Equations (3.79) and (3.80), the condition for $v_{achi} = v_{inp}$ and $a_{achi} < a_{ac} = a_{inp}$ is determined by system of inequality (3.81).

$$\begin{cases} \frac{s_{inp}}{v_{inp}} - 2 \cdot \sqrt{\frac{v_{inp}}{r}} \geq 0 \\ v_{achi} = v_{inp} < \frac{a_{inp}^2}{r} \end{cases} \quad (3.81)$$

Case 4: Both of the speed and the acceleration reach to the input value (Fig. 3.7). In this case, SRV moves in long enough distance and then the speed and the acceleration are enough time to reach input values. It means that $v_{achi} = v_{inp}$ and $a_{achi} = a_{ac}$.

The acceleration values in the acceleration and deceleration phases are quantitatively identical and then the times and the distances of the acceleration and deceleration phases are determined by Equations (3.82) and (3.83). The distance of the constant speed is presented by Equation (3.84) and the time of this distance is shown by Equation (3.85). The total movement time is shown by Equation (3.86).

$$t_{ac} = t_{de} = t_3 = \frac{a_{ac}}{r} + \frac{v_{inp}}{a_{ac}} \quad (3.82)$$

$$s_{ac} = s_{de} = s_3 = \frac{v_{inp}^2}{2 \cdot a_{ac}} + \frac{v_{inp} \cdot a_{ac}}{2 \cdot r} \quad (3.83)$$

$$s_{v_const} = s_{inp} - \frac{v_{inp}^2}{a_{ac}} - \frac{v_{inp} \cdot a_{ac}}{r} \quad (3.84)$$

$$t_{v_const} = \frac{s_{v_const}}{v_{inp}} = t_4 - t_3 = \frac{s_{inp}}{v_{inp}} - \frac{v_{inp}}{a_{ac}} - \frac{a_{ac}}{r} \quad (3.85)$$

$$t_{tot} = t_7 = t_4 + t_3 = \frac{s_{inp}}{v_{inp}} + \frac{v_{inp}}{a_{ac}} + \frac{a_{ac}}{r} \quad (3.86)$$

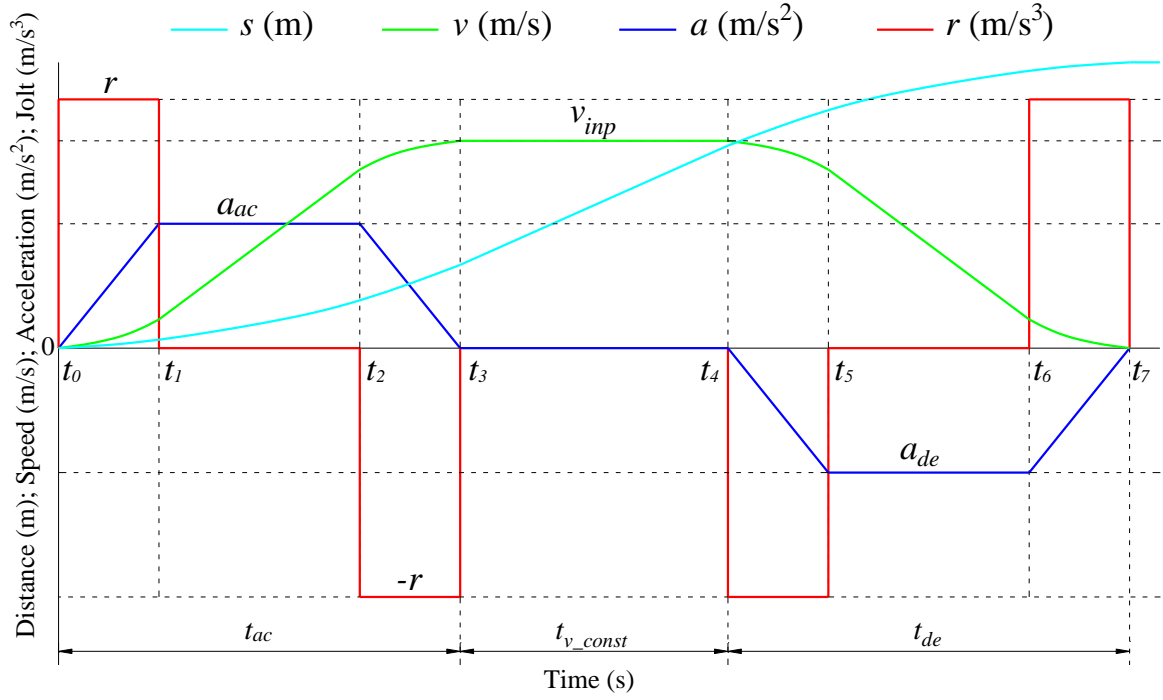

Figure 3.7: Example of movement curves when the speed and the acceleration reach the input values [2].

From $a_{achi} = a_{ac} = a_{inp}$ it is equivalent to $t_{ac} - t_1 \geq t_1$ then

$$\frac{a_{ac}}{r} + \frac{v_{inp}}{a_{ac}} - \frac{a_{ac}}{r} \geq \frac{a_{ac}}{r}$$

$$v_{inp} \geq \frac{a_{ac}^2}{r} \quad (3.87)$$

From $v_{achi} = v_{inp}$ it is equivalent to $t_{v_const} \geq 0$ then

$$t_{v_const} = \frac{s_{inp}}{v_{inp}} - \frac{v_{inp}}{a_{ac}} - \frac{a_{ac}}{r} \geq 0 \quad (3.88)$$

From Equations (3.87) and (3.88), the condition for $v_{achi} = v_{inp}$ and $a_{achi} = a_{ac}$ is determined by system of inequality (3.89).

$$\begin{cases} \frac{s_{inp}}{v_{inp}} - \frac{v_{inp}}{a_{inp}} - \frac{a_{inp}}{r} \geq 0 \\ v_{achi} = v_{inp} \geq \frac{a_{inp}^2}{r} \end{cases} \quad (3.89)$$

3.2.2 When acceleration values in the acceleration and deceleration phases are quantitatively different

When SRV moves on the rails and the acceleration values in the acceleration and deceleration phases are quantitatively different and then the eight different movement cases are distinguished (Fig. 3.8). The conditions to occur in each case are specified by the values of the movement distance, the speed and the acceleration as below [2].

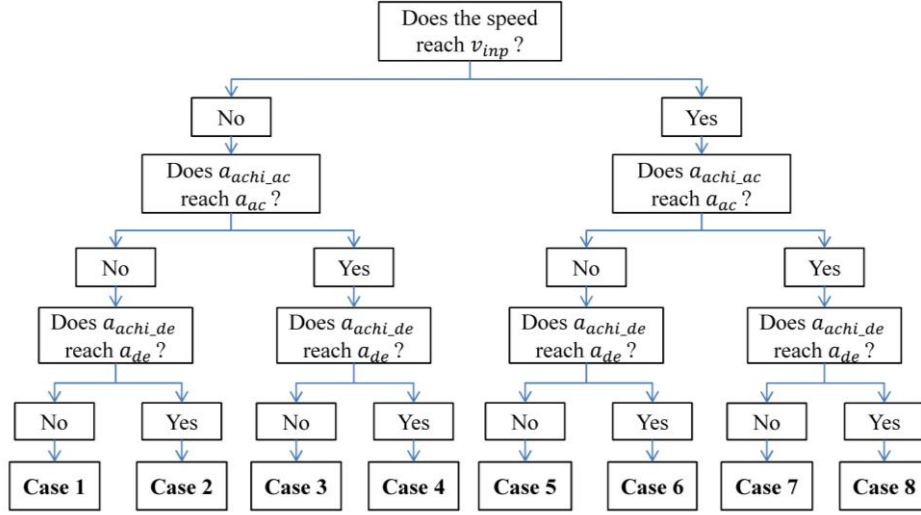

Figure 3.8: Differentiation of the movement cases when the acceleration values in the acceleration and deceleration phases are different [2].

Case 1: All values of the speed and the acceleration in the acceleration and deceleration phases do not reach the input values. The movement distance is short and the condition to satisfy this case is determined by system of inequality (3.90).

$$v_{inp} > v_{achi}; v_{achi} < \frac{a_{ac}^2}{r} \text{ and } v_{achi} < \frac{a_{de}^2}{r} \quad (3.90)$$

Case 2: The speed and the acceleration in the acceleration phase do not reach the input values and the acceleration value in the deceleration phase achieves a_{de} . The condition to satisfy this case is determined by system of inequality (3.91).

$$v_{inp} > v_{achi}; \frac{a_{de}^2}{r} \leq v_{achi} < \frac{a_{ac}^2}{r} \quad (3.91)$$

Case 3: The speed and the acceleration in the deceleration phase do not reach the input values and the acceleration value in the acceleration phase achieves a_{ac} . The condition to satisfy this case is shown by system of inequality (3.92).

$$v_{inp} > v_{achi}; \frac{a_{ac}^2}{r} \leq v_{achi} < \frac{a_{de}^2}{r} \quad (3.92)$$

Case 4: Both acceleration values reach a_{ac} and a_{de} and the speed does not reach v_{inp} . The

condition to satisfy this case is presented by system of inequality (3.93).

$$v_{achi} < v_{inp}; v_{achi} \geq \frac{a_{ac}^2}{r} \text{ and } v_{achi} \geq \frac{a_{de}^2}{r} \quad (3.93)$$

Case 5: The speed achieves v_{inp} and both acceleration values do not reach a_{ac} and a_{de} . The accelerations in this case are big and the speed is quite small and then the accelerations do not achieve the input value and the speed reach input value. The condition to satisfy this case is determined by system of inequality (3.94).

$$v_{achi} = v_{inp} < \frac{a_{ac}^2}{r} \text{ and } v_{achi} = v_{inp} < \frac{a_{de}^2}{r} \quad (3.94)$$

Case 6: The speed and the acceleration in the deceleration phase achieve the input values and the acceleration in the acceleration phase does not reach a_{ac} . In this case, the speed is small and the acceleration in the acceleration phase is quite big and do not achieve the input value. The condition to satisfy this case is shown by system of inequality (3.95).

$$v_{achi} = v_{inp} < \frac{a_{ac}^2}{r} \text{ and } v_{inp} \geq \frac{a_{de}^2}{r} \quad (3.95)$$

Case 7: The speed and the acceleration in the acceleration phase achieve the input values and the acceleration in the deceleration phase does not reach a_{de} . In this case, the speed is small and the acceleration in the deceleration phase is quite big and do not achieve the input value. The condition to satisfy this case is shown by system of inequality (3.96).

$$v_{achi} = v_{inp} \geq \frac{a_{ac}^2}{r} \text{ and } v_{inp} < \frac{a_{de}^2}{r} \quad (3.96)$$

Case 8: All values of the speed and the acceleration in the acceleration and deceleration phases reach to the input values. In this case, the movement distance is long enough and the condition to satisfy this case is determined by system of inequality (3.97).

$$v_{achi} = v_{inp} \geq \frac{a_{ac}^2}{r} \text{ and } v_{inp} \geq \frac{a_{de}^2}{r} \quad (3.97)$$

The calculations for the above eight cases are similar to those calculations when acceleration values in the acceleration and deceleration phases are quantitatively identical.

In reality, the acceleration values of the driving unit in the acceleration and deceleration phases are generally considered to be quantitatively identical. While the acceleration values of the lifting unit can be equal or different, but the energy need does not depend on the kinematic parameters of the lifting unit [2]. Therefore, to simplify the process of choosing the most efficient method of the energy need and the throughput, the acceleration values of the lifting unit are considered quantitatively identical. The difference of the accelerations in the acceleration and deceleration phases is not studied further accordingly.

3.3 Block diagram of the mathematical model when acceleration values in the acceleration and deceleration phases are quantitatively identical

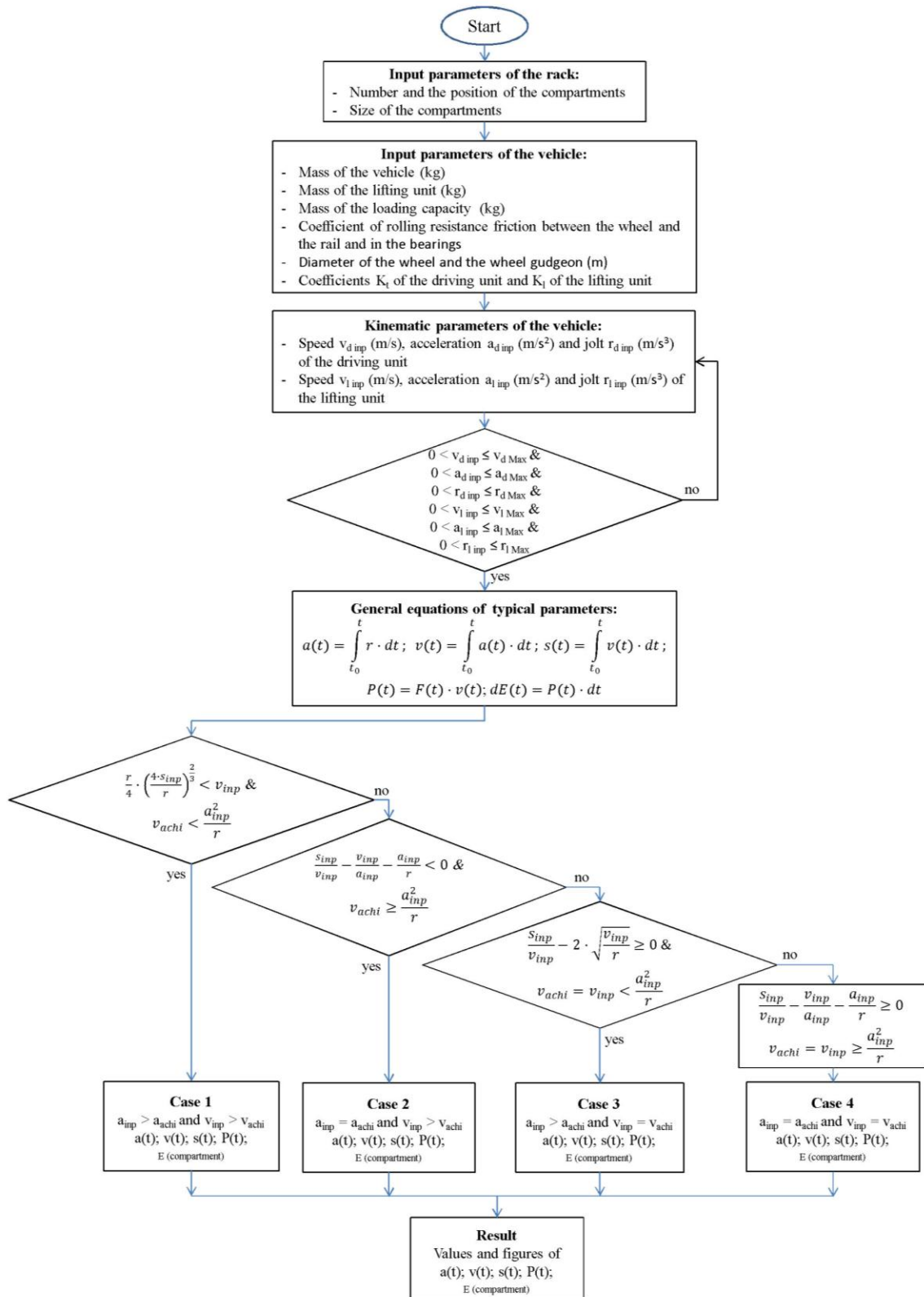

Figure 3.9: Block diagram of mathematical model of ASPW, when acceleration values in the acceleration and deceleration phases are quantitatively identical.

To establish the simulation model of the typical parameters of SRV, the block diagram is set up (Fig. 3.9). The sequence of steps in the operating process of SRV is simulated by the block diagram as follows:

The input parameters of the rack include the number, the size (length, width and depth) and the specific position of the compartments. SRV can move to the required compartment in the most accurate way respectively.

The input parameters of SRV include the mass of SRV, the lifting unit and the unit load; the coefficients of rolling resistance friction between the wheel and the rail and in the bearings; the diameter of the wheel and the wheel gudgeon (m); the coefficients K_d of the driving unit and K_l of the lifting unit. These coefficients only affect to the motor powers and the energy need of the movement units and do not affect to the kinematic parameters of SRV.

The input kinematic parameters of SRV include the input speed v_{dinp} (m/s), the input acceleration a_{dinp} (m/s²) and the input jerk r_{dinp} (m/s³) of the driving unit and the input speed v_{linp} (m/s), the input acceleration a_{linp} (m/s²) and the input jerk r_{linp} (m/s³) of the lifting unit. These parameters are limited from 0 to the maximum values that they can achieve in real system. And then the coefficients K_d of the driving unit and K_l of the lifting unit are satisfied.

The defined parameters are calculated by the general equations of the distance $s(t)$, the speed $v(t)$, the acceleration $a(t)$, the power $P(t)$ and the energy need in each compartment $E(i)$ of the driving unit and the lifting unit by the time. These parameters can be determined at any time by these equations.

Depending on the input parameters, one of four working cases of SRV is referred. Each case of the vehicle is used by the specific formulas in Section 3.2.1.

The results of the model: simulating the driving and lifting distance, the speed and the acceleration by the driving and lifting time; determining the consumption powers of the motors by the driving and lifting time; simulating the recovery power of the driving unit when the vehicle is the deceleration or the braking; simulating the recovery power of the lifting unit when the vehicle is lowered; determining the energy need of SRV at any compartment with any input value of the speed and the acceleration. The figures of the acceleration, the speed, the distance and the power by the time and the energy need of each compartment corresponding to the specific input parameters are determined accordingly.

3.4 Application of the simulation model of the vehicle at an experimental facility

The automatic small parts warehouse at the Institute of Logistics and Material Handling Systems (ILM) at the Otto-von-Guericke University Magdeburg was built in 2010. The simulation parameters of SRV are verified by this experimental model.

3.4.1 Description of the experimental model

The experimental model is constructed by two identical racks on the sides, of which SRV runs in the middle (Fig. 3.10).



Figure 3.10: Automatic small parts warehouse (ASPW) at the Institute (ILM).

The racks are used to store goods. Each rack has the following main parameters: the length of rack is 10 m; the height of rack is about 7.5 m including the engine foundation and the top of SRV; each rack has 20 compartments horizontally and 21 compartments vertically. Total compartments of each rack are 420 (20 x 21); the compartment has width of 0.5 m, height of 0.31 m and depth of 0.6 m.

I/O point is located in front of the rack at the height of the second row of rack.

Boxes to experiment: the quantities are 420 boxes; maximum loading capacity per box is 30 kg; three dimensions of the box are 400 x 270 x 600 mm.

The parameters of the storage and retrieval vehicle: the total mass of SRV is $m_v = 1996\text{kg}$, the height of SRV is $H_v = 7.5\text{m}$; the mass of the lifting unit is $m_{li} = 215\text{kg}$; the maximum

loading capacity is $m_{lmax} = 100\text{kg}$; the kinematic specifications of SRV include the maximum speed $v_{dmax} = 5\text{m/s}$, the maximum acceleration $a_{dmax} = 3\text{m/s}^2$ and the jerk $r_{dmax} = 6\text{m/s}^3$ of the driving unit; the maximum speed $v_{lmax} = 4\text{m/s}$, the maximum acceleration $a_{lmax} = 4\text{m/s}^2$ and the jerk $r_{lmax} = 8\text{m/s}^3$ of the lifting unit. The specifications of the storage and retrieval system are shown more clearly in Table 3.1.

	Configuration parameters	Unit	Value
The system	Dimension (L x H)	m	10 x 7.5
	The number of the racks		2
	The size of compartment	m	0.5 x 0.31
	The number of compartments		840
Box	Dimension	m	0.6 x 0.4 x 0.27
The driving unit	Mass	kg	1996
	The maximum speed	m/s	5
	The maximum acceleration	m/s^2	3
	The maximum jerk	m/s^3	6
The lifting unit	Mass	kg	215
	The maximum speed	m/s	4
	The maximum acceleration	m/s^2	4
	The maximum jerk	m/s^3	8

Table 3.1: Important parameters of the system.

In this experiment, SRV moves with a single operation cycle, the storage and retrieval are carried out in the compartments located in the diagonal of the system (Figure A.1 - Appendix A). As the result, the driving unit and the lifting unit move at all of the required distances and heights. The input speed of the driving unit changes from 1 m/s to 5 m/s and the step is 0.5 m/s, the input acceleration of the driving unit changes from 1 m/s^2 to 3 m/s^2 and the step is 1 m/s^2 , the jerk is constant 6 m/s^3 ; the input speed of the lifting unit changes from 1 m/s to 4 m/s, the step is 1 m/s and the input acceleration of the lifting unit changes from 1 m/s^2 to 4 m/s^2 , the step is 1 m/s^2 , the jerk is constant 8 m/s^3 . The results of the driving unit and the lifting unit are recorded independently and in this case, the break times of the units are ignored. The experimental results are recorded to excel files and then processed to determine the specific required parameters of each compartment (Table A.1 to A.17 - Appendix A). The experimental coefficients in the simulation model are determined by the data and the figures of the experimental results.

3.4.2 Determining the coefficients of the driving unit and the lifting unit

The coefficients K_t of the driving unit and K_l of the lifting unit in Equations (3.49) and (3.50) must be identified so that the simulation model satisfies all of the required parameters (the distance, the speed, the acceleration, the power, the time and the energy need) of the actual model.

From the experimental results and the equations to calculate typical parameters, the coefficients K_t of the driving unit and K_l of the lifting unit are determined in specific phases. The coefficients in a system must also be checked regularly every 3-6 months. If the error of the coefficient is less than 5%, the coefficient is still valid and vice versa (the coefficient must be redefined). The cause of the change in coefficients is that the efficiencies of the motors and the mechanical actuators decrease by the time. When the systems are different, these coefficients also have to be redefined. The coefficients of the driving unit and the lifting unit are determined independently and the processes to establish the equations of the coefficients are shown as below.

- The coefficients K_t of the driving unit

The driving unit moves on the general way, its movement is divided to three phases including the acceleration, the constant speed and the deceleration. The coefficients K_t are established by the specific equations in each phase.

When the driving unit moves with the constant speed, the acceleration is zero. The equation of the coefficient $K_t = K_{tcs}$ is linear and only depends on the input speed v_{dinp} of SRV. It is determined by Equation (3.98). The specific data of K_{tcs} in special cases of the speed is determined by Table B.1 - Appendix B.

$$K_t = K_{tcs} = 3.0835 + 2.6724 \cdot v_{dinp} \quad (3.98)$$

When the driving unit is acceleration, the coefficient $K_t = K_{ta}$ depends on both of the input speed v_{dinp} and the input acceleration a_{dinp} and determined by Equation (3.99). The specific data of K_{ta} in individual cases of the speed and the acceleration is determined by Table B.2 - Appendix B.

$$K_t = K_{ta} = 0.5532 + \frac{0.596}{a_{dinp}^{0.5}} + 0.2132 \cdot v_{dinp}^{0.5} \quad (3.99)$$

When the driving unit is deceleration, the coefficient $K_t = K_{td}$ depends on both of the input speed v_{dinp} and the input acceleration a_{dinp} and determined by Equation (3.100). The specific data of K_{td} in individual cases of the speed and the acceleration is determined by Table B.3 - Appendix B.

$$K_t = K_{td} = 0.749 - \frac{0.249}{a_{dimp}^{1.5}} + \frac{0.191}{v_{dimp}^{1.5}} \quad (3.100)$$

- The coefficients K_l of the lifting unit

From the experimental results, the energy need of the lifting unit does not depend on the speed and the acceleration [2]. When the lifting unit lifts or lowers the goods, the energy need depends mainly on the inertial resistance force and the resistance force of the earth's gravity. The other resistance forces and the general efficiency of the lifting unit do not significantly change when the speed and the acceleration change. Therefore, the coefficients K_l are the fixed values and it does not depend on the speed and the acceleration of the lifting unit. It is divided into two separate processes namely the lifting and lowering process. The lifting process is the energy consumption and the lowering process is the energy recovery accordingly. From Table A.1 to A.17 - Appendix A, the energy recovery rate of the lifting unit based on the experimental results is quite high about 70% of the energy consumption on every lifting height and every kinematic parameter.

When the lifting unit lifts the goods, the coefficient $K_l = K_{ll} = 1.088$

When the lifting unit lowers the goods, the coefficient $K_l = K_{lr} = 0.76$

The coefficients of the driving unit and the lifting unit are determined and then they are added to the simulation model to calculate the required parameters of SRV.

3.5 Model validation

The simulation model can determine the energy need, the moving time and the lifting time at any position with any requirement of the speed and the acceleration. Once, the coefficients are determined, the simulation model must be rechecked by comparing its results (data and figures) with the experimental results. The energy need of the lifting unit does not depend on the speed and the acceleration [2]. Hence, it is unnecessary to compare the results of the lifting unit.

With the driving unit, the motor power is verified by comparing the data of the experiment model and the simulation model. To make the comparison, some compartments and some kinematic parameters of the vehicle are chosen and then the motor powers of the experiment model and the simulation model in each case are shown and simulated on the same figure to determine the reliability of the model. The motor powers in some cases of the driving speed are illustrated by Fig. 3.11 when the acceleration is $a_{dimp} = 3 \text{ m/s}^2$. The experimental values waver around the simulation values (Fig. 3.11) so they suit with the verification requirement.

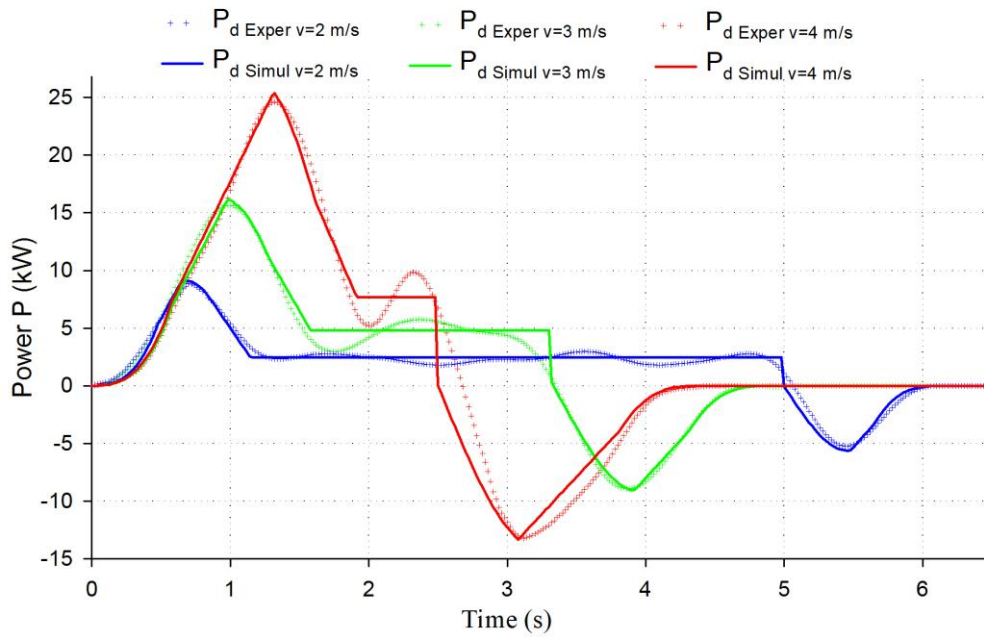

Figure 3.11: Comparison among the motor powers of the driving unit by the time when the input acceleration is 3 m/s^2 .

The driving time and the energy need of the driving unit are determined by the experimental model and the simulation model and calculated in each specific compartment when the driving unit moves from I/O point to the corresponding compartment. In some specific cases of the driving unit speed, the comparison results of the driving time of these models are illustrated in Fig. 3.12 when the acceleration is $a_{dinp} = 2 \text{ m/s}^2$ and in Fig. 3.13 when the acceleration is $a_{dinp} = 3 \text{ m/s}^2$.

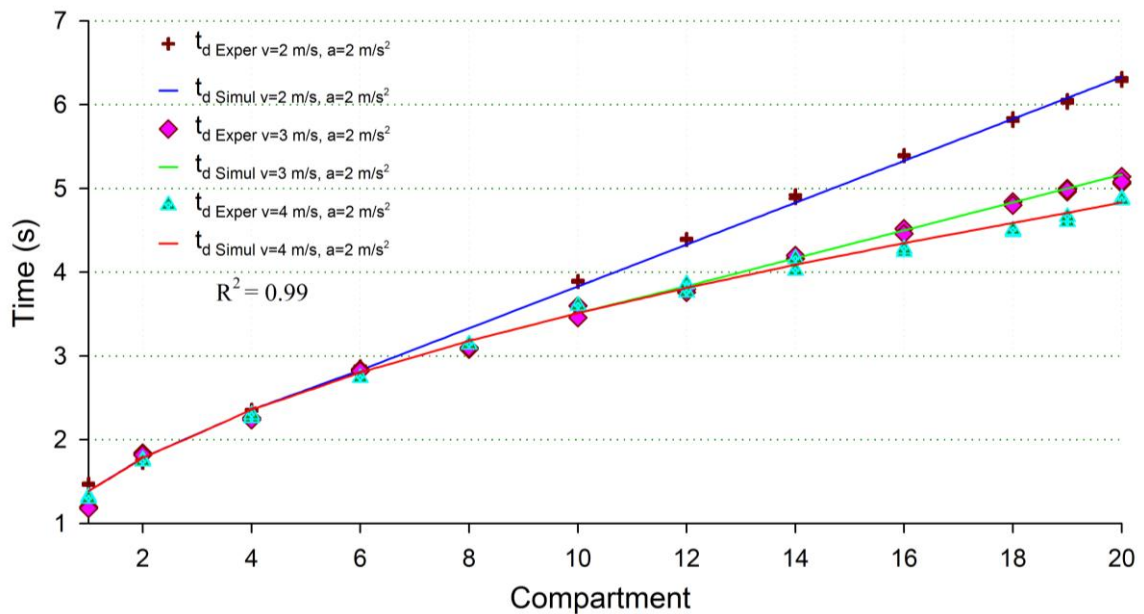

Figure 3.12: Comparison among the driving times of the models by the storage compartments when the input acceleration is 2 m/s^2 .

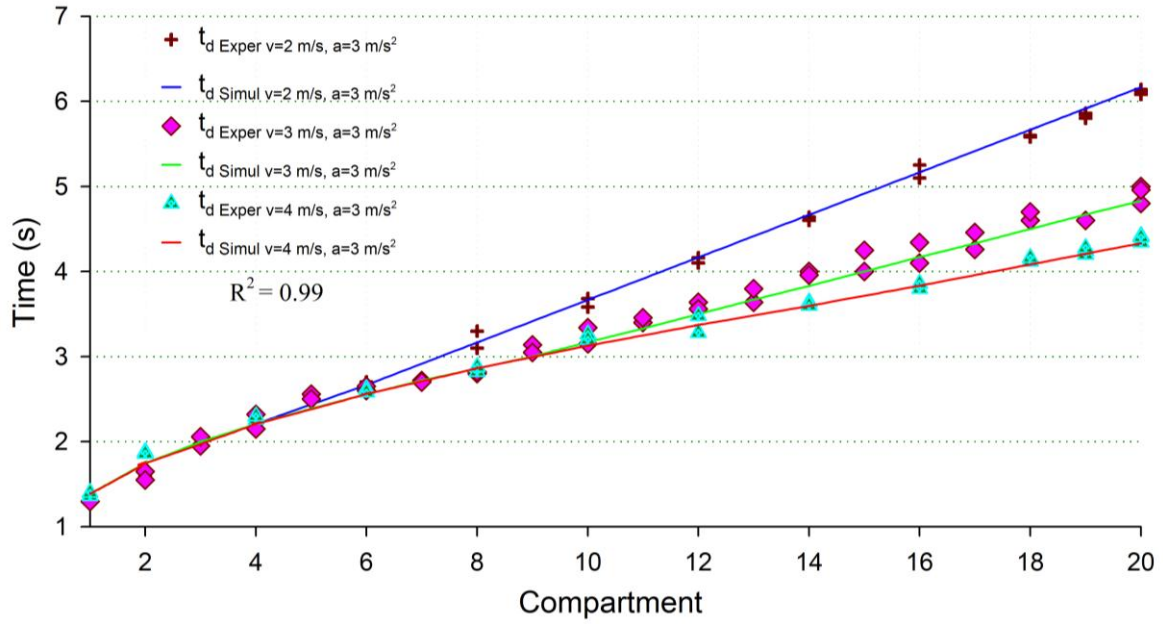

Figure 3.13: Comparison among the driving times of the models by the storage compartments when the input acceleration is 3 m/s^2 .

In some specific cases of the driving unit speed, the comparison results of the energy need are illustrated in Fig. 3.14 when the input acceleration is $a_{dinp} = 2 \text{ m/s}^2$ and in Fig. 3.15 when the input acceleration is $a_{dinp} = 3 \text{ m/s}^2$.

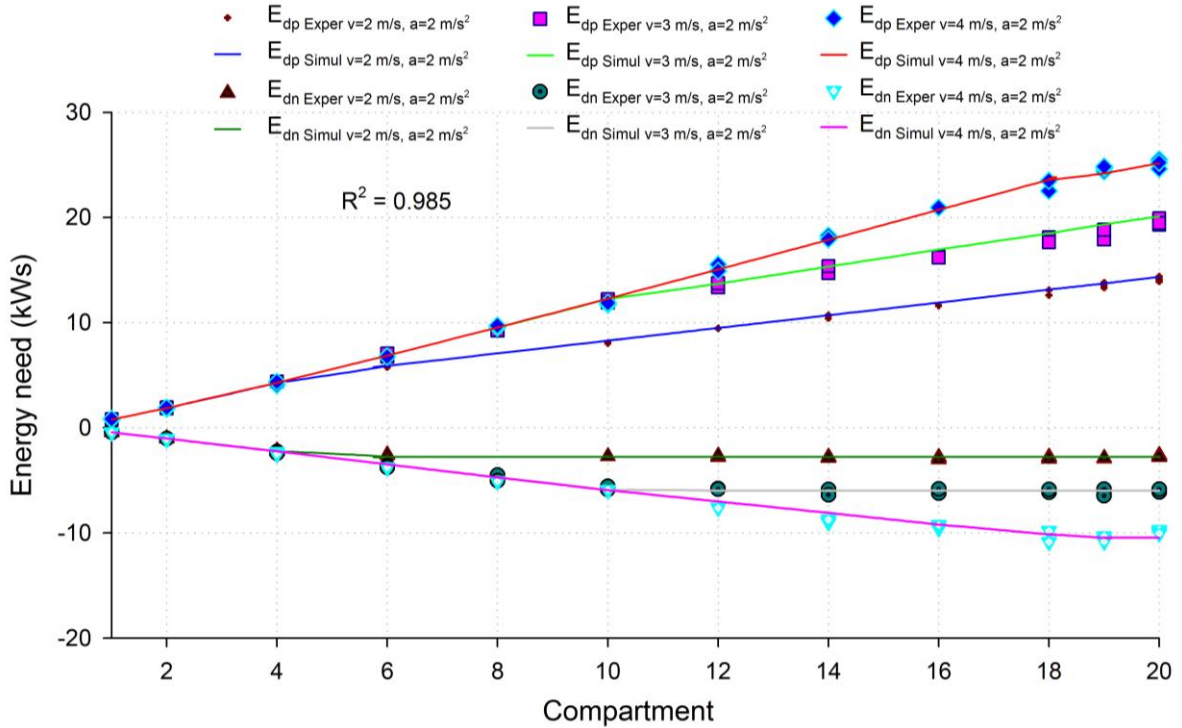

Figure 3.14: Comparison among the energy need of the driving unit by the storage compartments when the input acceleration is 2 m/s^2 .

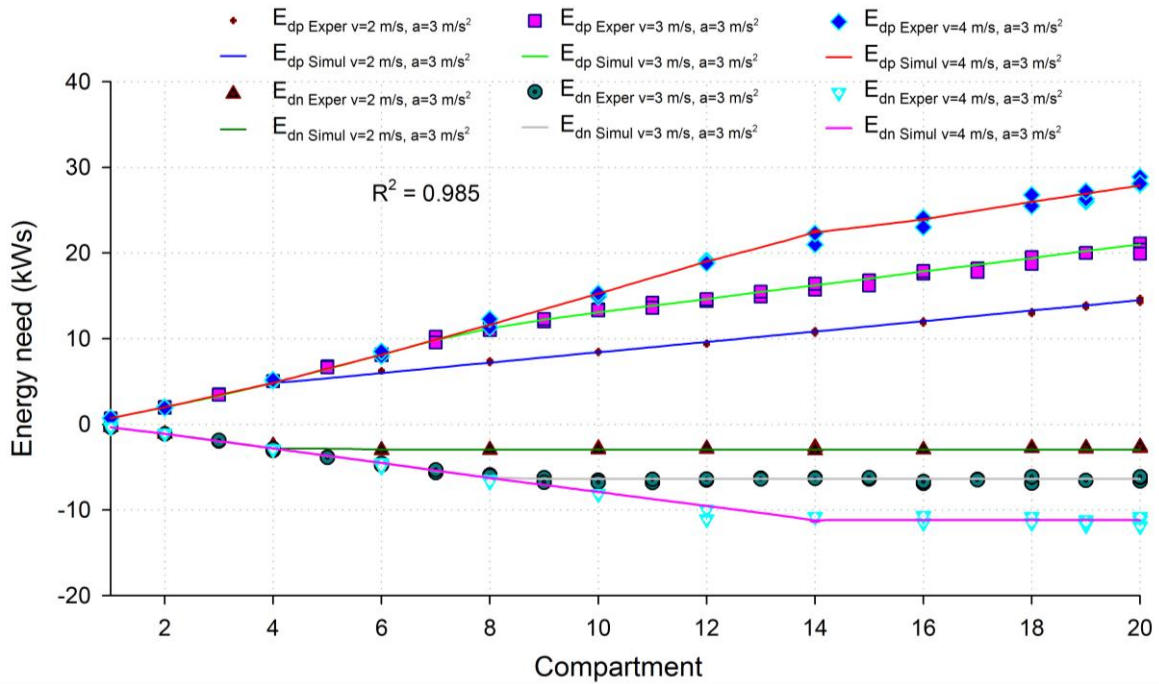

Figure 3.15: Comparison among the energy need of the driving unit by the storage compartments when the input acceleration is 3 m/s^2 .

The compared results (the motor power, the energy need and the moving time) of the experimental values and the simulation values show the coefficients of determination $R^2 = 0.985 \div 0.99$. These values are highly reliable. Therefore, the simulation model can be applied to determine the energy need and the moving time in any compartment with diversifying the speed and the acceleration. From this simulation model, the energy need and the moving time of SRV are considered by the different operating conditions and the specific strategies to help SRV to achieve the highest efficiency. The different operating conditions and the logical choice strategies between the storage and retrieval compartments are presented by the next chapters.

Chapter 4

Control the kinematic parameters of the vehicle to achieve high efficiencies and analyze the average energy need and throughput of working cycles

The energy need does not depend on the lifting unit speed and acceleration. When the speed and the acceleration are great, the machine parts deteriorate quickly. Therefore, the speed and the acceleration of the lifting unit are adjusted by the driving time of the driving unit to achieve the best energy efficiency. Depending on the moving distance, the speed and the acceleration, SRV can reach the all of seven phases or not (Section 3.2.1). In these cases, the kinematic parameters of SRV can be controlled in different ways to meet the required throughput and the high energy efficiency. The average energy need and the average throughput of working cycles are also analyzed to clarify the effectiveness of the strategies established in the following sections.

4.1 Vehicle moves in the distances for only the startup and braking phases

When SRV moves in the distances for only the startup and braking phases, the driving unit and the lifting unit are considered separately as follow.

4.1.1 Driving unit

The driving unit moves in the distances for only the startup and braking phases, the energy recovery rate compared with the energy consumption is higher than its rate in the long distances due to the energy recovery is only achieved in the deceleration phase and the

consumption energy is used in the startup phase and the constant speed phase. When the moving distance of the vehicle is longer than the total distances of the startup and braking phases, the energy recovery is constant. Hence, the long moving distances are not effective due to the energy recovery rate compared with the energy consumption is low.

From the simulation model, the relationship among the distance, the speed and the acceleration are established (Fig. 4.1) when SRV moves from I/O point to the corresponding position. The achieved speed does not reach the input speed in Zone I and reaches the input speed in Zone II. Zone I is presented by the distances for only the startup and braking phases and it is the object to analyze in this section.

When the input acceleration is constant and the input speed increases (Fig. 4.1), the driving unit moves in the longer startup and braking distance (s_{sb}) and this distance increases quite a lot when the input acceleration is low, e.g.:

when $a_{d\text{inp}} = 3 \text{ m/s}^2$: if $v_{d\text{inp}} = 2 \text{ m/s}$ then $s_{sb} = 2.3 \text{ m}$ and if $v_{d\text{inp}} = 3 \text{ m/s}$ then $s_{sb} = 4.5 \text{ m}$;

when $a_{d\text{inp}} = 1 \text{ m/s}^2$: if $v_{d\text{inp}} = 2 \text{ m/s}$ then $s_{sb} = 4.3 \text{ m}$ and if $v_{d\text{inp}} = 3 \text{ m/s}$ then $s_{sb} = 9.5 \text{ m}$.

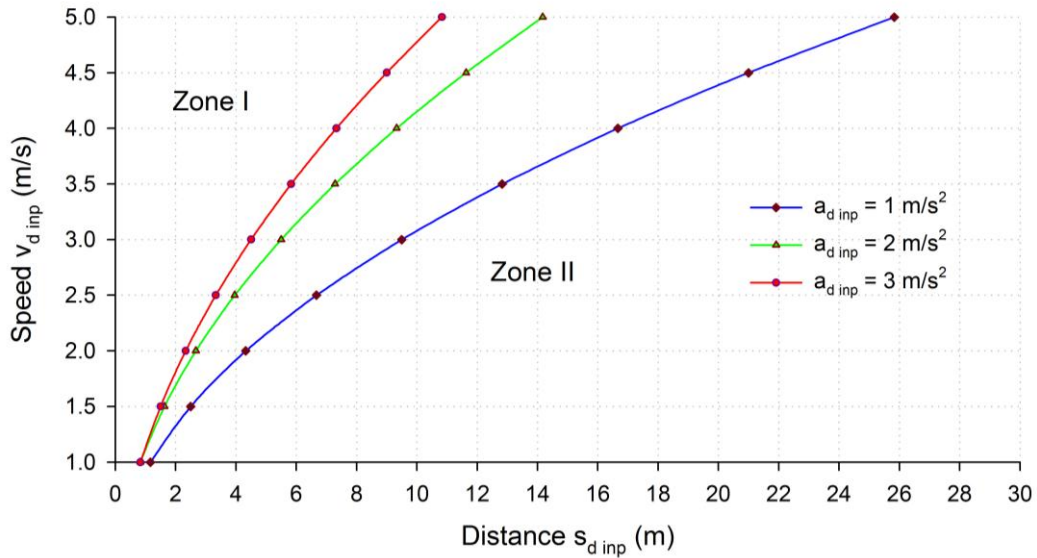

Figure 4.1: Moving distances for only the startup and braking phases.

Zone I does not reach the input speed and Zone II reaches the input speed.

When the input acceleration increases and the input speed is constant, the driving unit moves in the shorter startup and braking distance and this distance decreases quite a lot when the input speed is high, e.g.:

when $v_{d\text{inp}} = 2 \text{ m/s}$: if $a_{d\text{inp}} = 1 \text{ m/s}^2$ then $s_{sb} = 4.3 \text{ m}$ and if $a_{d\text{inp}} = 3 \text{ m/s}^2$ then $s_{sb} = 2.3 \text{ m}$;

when $v_{d\text{inp}} = 4 \text{ m/s}$: if $a_{d\text{inp}} = 1 \text{ m/s}^2$ then $s_{sb} = 16.6 \text{ m}$ and if $a_{d\text{inp}} = 3 \text{ m/s}^2$ then $s_{sb} = 7.3 \text{ m}$.

The driving time (t_{dri}) and the energy need (E_{dri}) of the driving unit are considered when it moves in the distances for only the startup and braking phases (Zone I):

When the input acceleration is constant and the input speed changes on the same distance, t_{dri} and E_{dri} are constant values (Table 4.1), e.g. when $s_{dinp} = 3.5$ m and $a_{dinp} = 2$ m/s² and then the energy need and the driving time are constant ($E_{dri} = 4.055$ kW and $t_{dri} = 3$ s) when $v_{dinp} = 2.5 \div 4$ m/s. For these cases, the achieved maximum speeds (v_{err}) of the driving unit are the same and smaller than the input values (v_{dinp}).

s_{dinp} (m)	v_{dinp} (m/s)	a_{dinp} (m/s ²)	E_{dri} (kW)	t_{dri} (s)
3.5	2,5	2	4.055	3
3.5	3	2	4.055	3
3.5	3,5	2	4.055	3
3.5	4	2	4.055	3
7	3,5	2	9.64	4.09
7	4	2	9.64	4.09
7	4.5	2	9.64	4.09
7	5	2	9.64	4.09
7	4	3	11.33	3.6
7	4.5	3	11.33	3.6
7	5	3	11.33	3.6

Table 4.1: Moving time and energy need when the speed changes.

On the same distance, when the input speed is constant, and then the bigger acceleration is, the lower driving time is and the more energy need is (Table 4.2), e.g. when $s_{dinp} = 3$ m and $v_{dinp} = 2.5$ m/s and then the energy need increases $E_{dri} = 2.75 \div 3.74$ kW when the input acceleration increases $a_{dinp} = 1 \div 3$ m/s² and the driving time reduces $t_{dri} = 3.63 \div 2.56$ s.

s_{dinp} (m)	v_{dinp} (m/s)	a_{dinp} (m/s ²)	E_{dri} (kW)	t_{dri} (s)
3	2.5	1	2.75	3.63
3	2.5	2	3.42	2.81
3	2.5	3	3.74	2.56
4	3	1	3.83	4.17
4	3	2	4.85	3.18
4	3	3	5.47	2.86
7	4	2	9.64	4.09
7	4	3	11.33	3.6

Table 4.2: Moving time and energy need when the acceleration changes.

When $v_{dinp} \square a_{dinp}$ (Case 3, Section 3.2.1), the above cases are not applied due to the speed increases to the input value and the acceleration does not reach to the input value so the achieved acceleration is smaller than the input value. As the result, the changes of the

energy need and the driving time are different to above rules. This case is rarely applied in reality so it is not considered further.

For above reasons, SRV moves in the distances for only the startup and braking phases: when the input acceleration decreases, it makes the energy need decreased and the driving time increased. However, the energy need and the driving time are constant, when the input speed changes. It means that when the input acceleration increases, SRV moves faster and does not depend on the input speed.

When the driving unit moves in the short distances and the unit load is lifted quite highly, the lifting unit speed is adjusted more quickly and the driving unit acceleration is adjusted to be smaller in order that the lifting unit and driving unit simultaneously arrive at the destination, and then the energy efficiency is higher in the required working time.

4.1.2 Lifting unit

When the lifting unit lifts or lowers the unit load in the heights for only the startup and braking phases, the lifting time of increasing the acceleration decreases and the lifting time of increasing the speed is constant (the same as the driving time of the driving unit). Whereas, the energy need of the lifting unit is constant with every lifting unit speed and acceleration [2]. Hence, the lifting unit acceleration should be adjusted to increase when the lifting time is required faster and the energy efficiency is constant.

To sum up, when the kinematic parameters change, the positions of the compartments are determined that the driving unit and lifting unit only move in the startup and braking phases or in full phases. The appropriate measures to control the driving unit and the lifting unit in the distances for only the startup and braking phases are shown to get the best efficiencies accordingly.

4.2 Optimizing the energy need with the required time in the given distances

When SRV moves with the required time in the given distances, the kinematic parameters should be considered to achieve the best energy efficiency. The rules to adjust the kinematic parameters of SRV are shown to achieve the lowest energy need and the throughput does not change respectively. The kinematic parameters of SRV are considered in both cases: SRV has or has not the energy recovery system. Due to the different operating characteristics of the driving unit and the lifting unit, they are considered separately and then combined to control SRV for the high efficiency.

4.2.1 Driving unit

To optimize the energy need with the required time in the given distances of the driving unit, the relationship between the driving unit speed and the driving time is established first in every compartment of the system, when the acceleration is changeable. And then, the relationship between the energy need and the driving time is determined. The relationship

between the driving unit speed and the driving time does not depend on whether SRV has the energy recovery system or not, e.g. the relationships between the speed and the driving time when $s_{d\text{inp}} = 3\text{ m}$ and $s_{d\text{inp}} = 8\text{ m}$ are illustrated by Fig. 4.2 and 4.3.

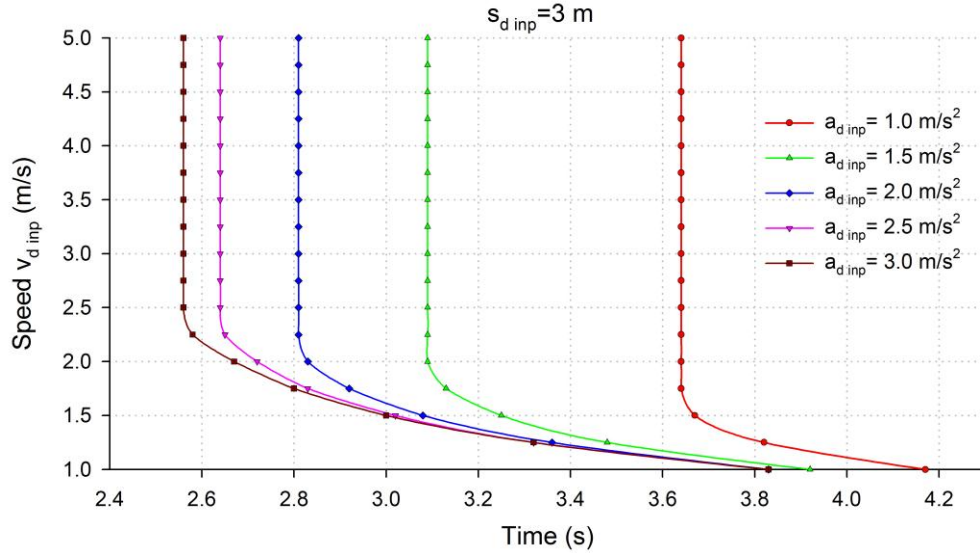

Figure 4.2: Relationship between the speed and the driving time when the distance is 3 m.

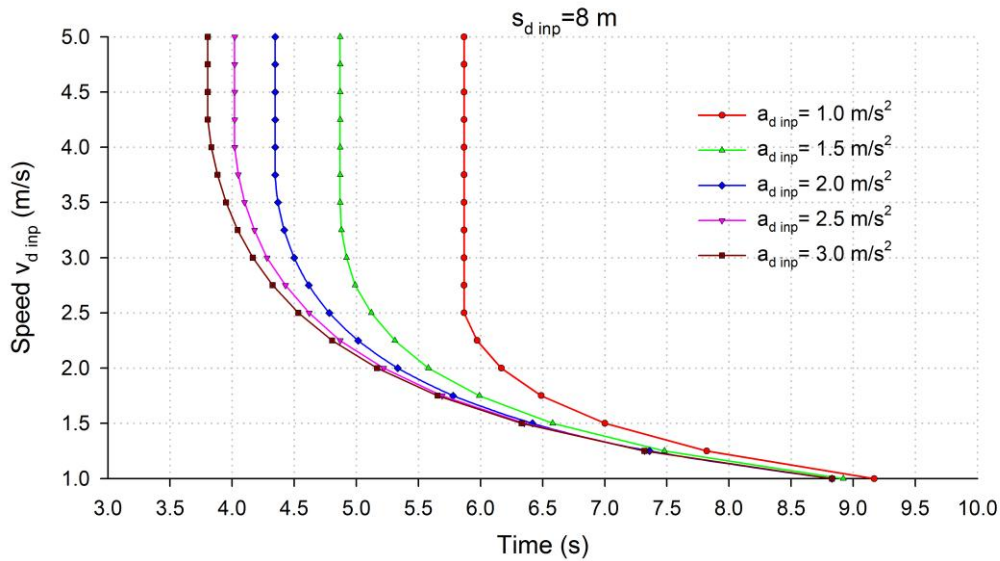

Figure 4.3: Relationship between the speed and the driving time when the distance is 8 m.

When the acceleration is fixed and the speed is changeable in the given distance, the speed increases to a certain value, the driving time and the energy need of the driving unit are not changeable. In this case, the achieved speed does not reach the input value (the driving unit moves in the distances for only the startup and braking phases), e.g. when $s_{d\text{inp}} = 8\text{ m}$ and $a_{d\text{inp}} = 2\text{ m/s}^2$ (Fig. 4.3), the input speed increases from 3.75 m/s to 5 m/s and then the driving time, the achieved speed and the energy need of the driving unit are constant $t_{dri} = 4.35\text{ s}$, $v_{achi} = 3.68\text{ m/s}$ and $E_{dri} = 11.46\text{ kW}$.

After the relationship between the driving unit speed and the driving time is established, the relationship between the energy need and the driving time is determined in every compartment of the system, when the acceleration is changeable, e.g. when SRV has the energy recovery system, the relationship between the energy need and the driving time is illustrated in Fig. 4.4 ($s_{d\text{inp}} = 3\text{ m}$) and Fig. 4.6 ($s_{d\text{inp}} = 8\text{ m}$); when SRV has not the energy recovery system, their relationship is illustrated in Fig. 4.5 ($s_{d\text{inp}} = 3\text{ m}$) and Fig. 4.7 ($s_{d\text{inp}} = 8\text{ m}$). The required driving time is calculated by the required throughput of SRV and then the lowest energy consumption can be determined following the required driving time and the acceleration in each compartment.

From the relationship between the energy need and the driving time (see Fig. 4.4 to 4.7) in both cases of SRV (SRV has or has not the energy recovery system) and in each required driving time, the bigger the acceleration is, the lower the energy need is, e.g.:

SRV has the energy recovery system: when $s_{d\text{inp}} = 3\text{ m}$ (Fig. 4.4) and the required time $t_{dri} = 3\text{ s}$, if $a_{d\text{inp}} = 2\text{ m/s}^2$ then $E_{dri} = 2.86\text{ kW}$ s and if $a_{d\text{inp}} = 3\text{ m/s}^2$ then $E_{dri} = 2.64\text{ kW}$ s . It means that the saved energy is 7.7% when $a_{d\text{inp}}$ is adjusted from 2 m/s^2 to 3 m/s^2 ;

SRV has not the energy recovery system: when $s_{d\text{inp}} = 3\text{ m}$ (Fig 4.5) and the required time $t_{dri} = 3\text{ s}$, if $a_{d\text{inp}} = 2\text{ m/s}^2$ then $E_{d\text{pos}} = 4.77\text{ kW}$ s and if $a_{d\text{inp}} = 3\text{ m/s}^2$ then $E_{d\text{pos}} = 4.36\text{ kW}$ s . It means that the saved energy is 8.6% when $a_{d\text{inp}}$ is adjusted from 2 m/s^2 to 3 m/s^2 .

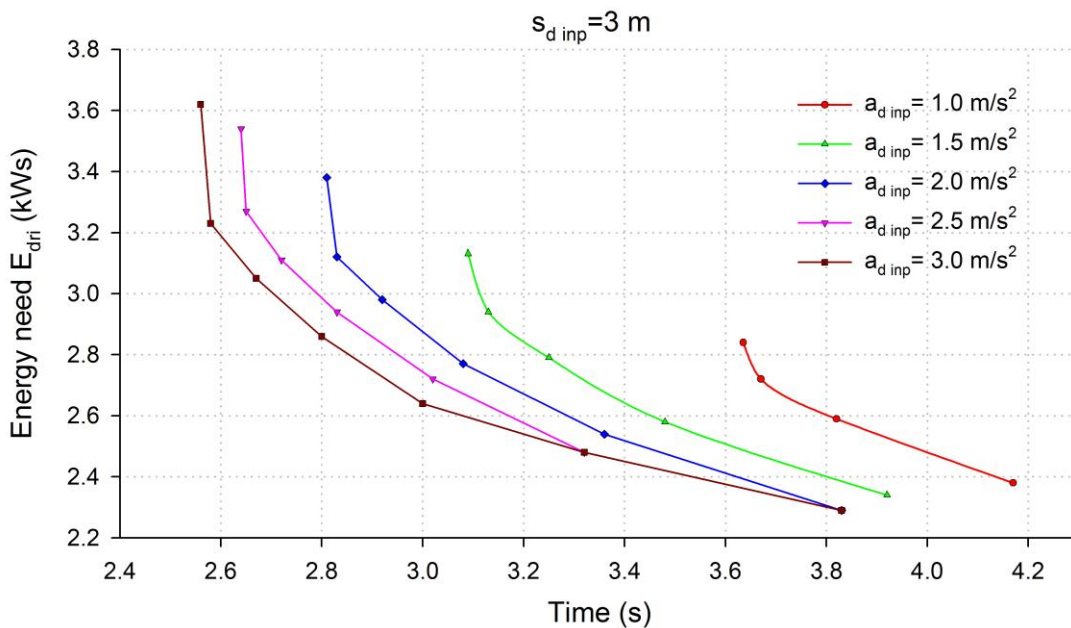

Figure 4.4: Relationship between the energy need and the driving time when the distance is 3 m and SRV has the energy recovery system.

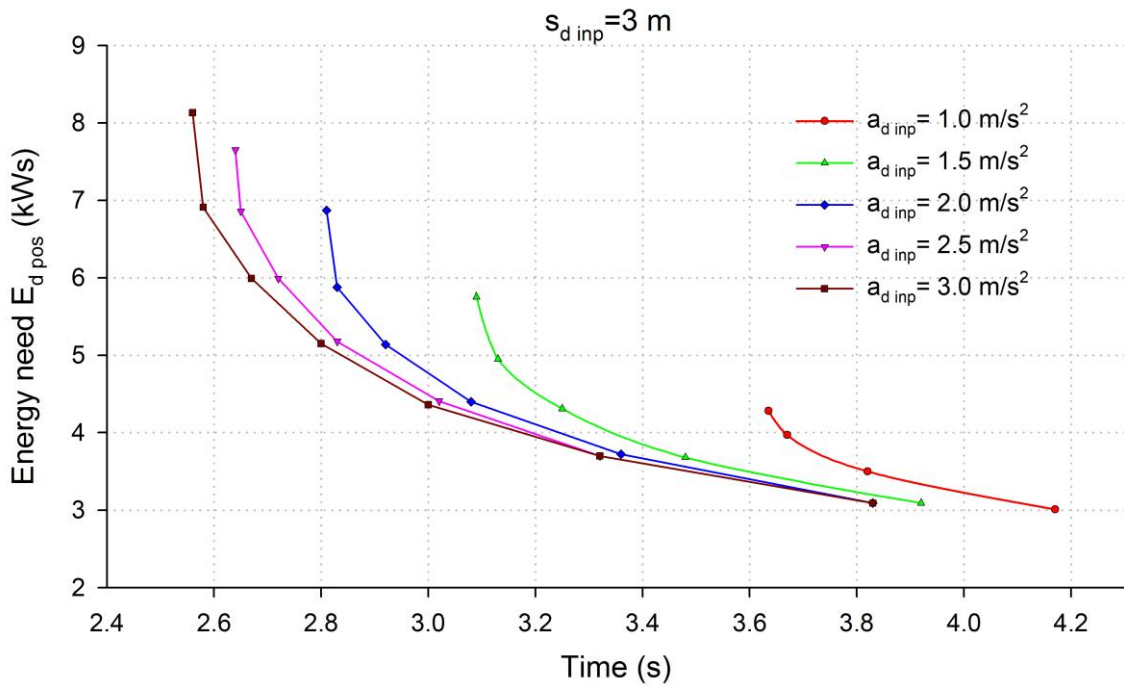

Figure 4.5: Relationship between the energy need and the driving time when the distance is 3 m and SRV has not the energy recovery system.

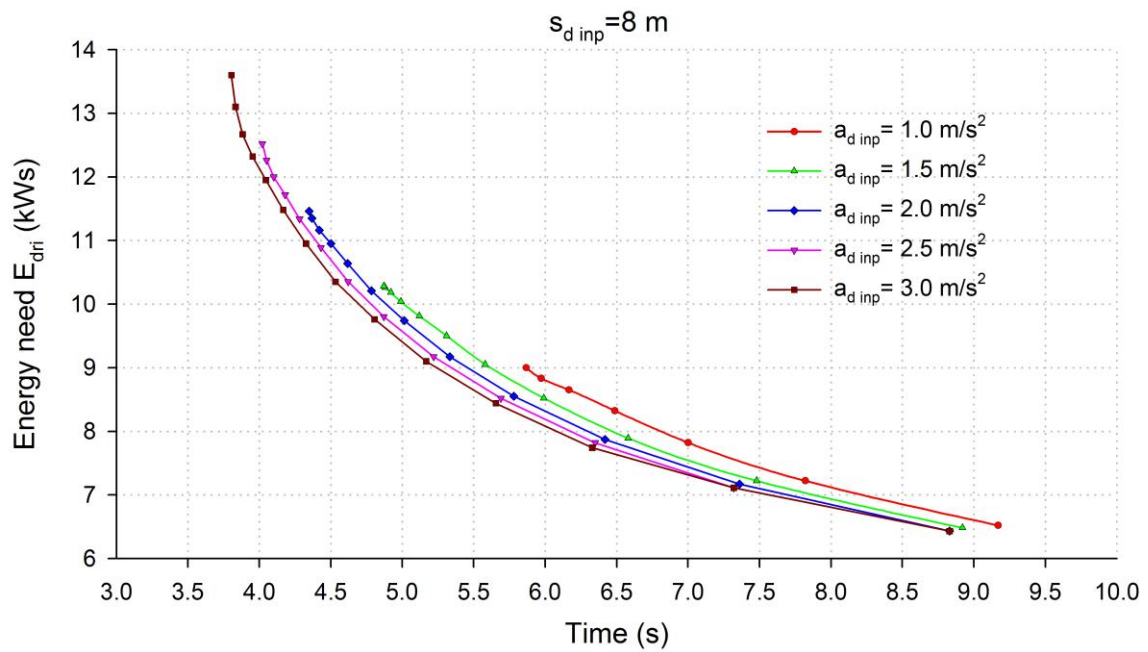

Figure 4.6: Relationship between the energy need and the driving time when the distance is 8 m and SRV has the energy recovery system.

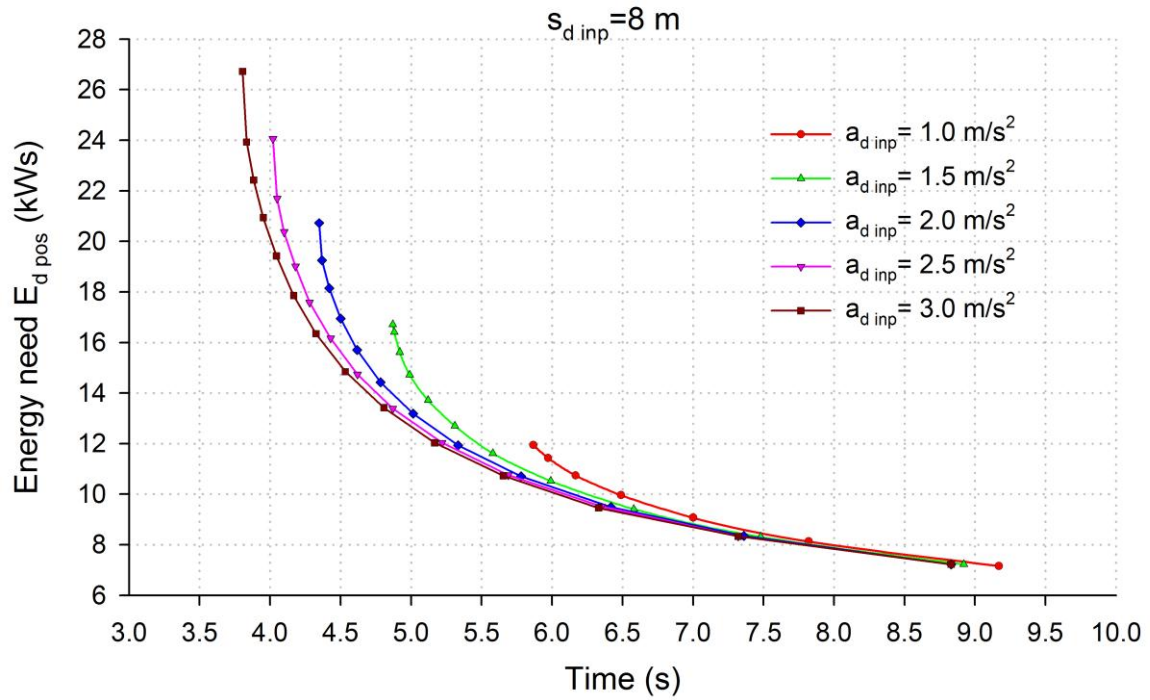

Figure 4.7: Relationship between the energy need and the driving time when the distance is 8 m and SRV has not the energy recovery system.

However, the energy need changes quite a lot when the acceleration changes from 1 m/s^2 to 2 m/s^2 and changes a little bit when the acceleration changes from 2 m/s^2 to 3 m/s^2 , e.g.

SRV has the energy recovery system: when $s_{d_inp} = 8 \text{ m}$ (Fig 4.6) and the required time $t_{dri} = 6 \text{ s}$, if $a_{d_inp} = 1 \text{ m/s}^2$ then $E_{dri} = 8.8 \text{ kW}$ s, if $a_{d_inp} = 2 \text{ m/s}^2$ then $E_{dri} = 8.3 \text{ kW}$ s and if $a_{d_inp} = 3 \text{ m/s}^2$ then $E_{dri} = 8.1 \text{ kW}$ s. Hence, the saved energy is 5.7% when a_{d_inp} is adjusted from 1 m/s^2 to 2 m/s^2 and is 2.4% when a_{d_inp} is adjusted from 2 m/s^2 to 3 m/s^2 ;

SRV has not the energy recovery system: when $s_{d_inp} = 8 \text{ m}$ (Fig 4.7) and the required time $t_{dri} = 6 \text{ s}$, if $a_{d_inp} = 1 \text{ m/s}^2$ then $E_{d_pos} = 11.4 \text{ kW}$ s, if $a_{d_inp} = 2 \text{ m/s}^2$ then $E_{d_pos} = 10.3 \text{ kW}$ s and if $a_{d_inp} = 3 \text{ m/s}^2$ then $E_{d_pos} = 10.1 \text{ kW}$ s. Hence, the saved energy is 9.6% when a_{d_inp} is adjusted from 1 m/s^2 to 2 m/s^2 and is 1.9% when a_{d_inp} is adjusted from 2 m/s^2 to 3 m/s^2 .

The relationship between the energy need and the driving time in each Figure (Fig 4.4 to 4.7) has some positions that coincide with each other when the input acceleration of SRV changes, e.g. $s_{d_inp} = 3 \text{ m}$ (Fig. 4.4 and 4.5), the energy need in case of $a_{d_inp} = 2.5 \text{ m/s}^2$ is the same to the one in case of $a_{d_inp} = 3 \text{ m/s}^2$ when the driving time is chosen from $3.4 \div 3.8 \text{ s}$. The reason is that at these positions, the input acceleration of SRV is too large compared to the input speed ($a_{d_inp} = 2.5 \div 3 \text{ m/s}^2$ and $t_{dri} = 3.4 \div 3.8 \text{ s}$, from Figure 4.2 then

$v_{dinp} = 1 \div 1.25 \text{ m/s}^2$). Therefore, the achieved acceleration in these cases does not reach the input value but the achieved speed reaches the input value (see Case 3 Section 3.2.1) and then the energy need and the driving time of SRV in these cases are the same.

The driving unit achieves the best energy efficiency in the required driving time on the given distance when the achieved maximum acceleration at this time is selected in both cases of SRV (SRV has or has not the energy recovery system), e.g. when $s_{dinp} = 8 \text{ m}$ (Fig. 4.6) and $t_{dri} = 6 \text{ s}$, selecting $a_{dinp} = 3 \text{ m/s}^2$; when $s_{dinp} = 8 \text{ m}$ and $t_{dri} = 8 \text{ s}$, selecting $a_{dinp} = 2 \text{ m/s}^2$ and then the energy efficiency of the driving unit is the best.

The shorter the driving distance of the vehicle is, the better the saving efficiency of the energy consumption by selecting the appropriate acceleration is, e.g.:

when $s_{dinp} = 3 \text{ m}$ (Fig. 4.4), if $t_{dri} = 3 \text{ s}$, selecting $a_{dinp} = 3 \text{ m/s}^2$ then $E_{dri} = 2.64 \text{ kWs}$, selecting $a_{dinp} = 2 \text{ m/s}^2$ then $E_{dri} = 2.86 \text{ kWs}$, gap is 7.7%; if $t_{dri} = 3.8 \text{ s}$, selecting $a_{dinp} = 2 \text{ m/s}^2$ then $E_{dri} = 2.32 \text{ kWs}$, selecting $a_{dinp} = 1 \text{ m/s}^2$ then $E_{dri} = 2.64 \text{ kWs}$, gap is 12.12%.

when $s_{dinp} = 8 \text{ m}$ (Fig. 4.6), if $t_{dri} = 6 \text{ s}$, selecting $a_{dinp} = 3 \text{ m/s}^2$ then $E_{dri} = 8.1 \text{ kWs}$, selecting $a_{dinp} = 2 \text{ m/s}^2$ then $E_{dri} = 8.3 \text{ kWs}$, gap is 2.4% and selecting $a_{dinp} = 1 \text{ m/s}^2$ then $E_{dri} = 8.8 \text{ kWs}$, gap is 5.7% with $a_{dinp} = 2 \text{ m/s}^2$.

The relationship between the energy need and the required time aims to determine the input acceleration to achieve the best energy efficiency. And then, the required speed is determined to have the lowest energy need and get the required throughput (Fig. 4.2 and 4.3). Due to the required driving time, the bigger the acceleration is, the lower the energy need is. The required speed can be determined to get the best energy efficiency accordingly, e.g. when $s_{dinp} = 8 \text{ m}$ and $t_{dri} = 6 \text{ s}$, from Fig. 4.6 selecting $a_{dinp} = 3 \text{ m/s}^2$ and then from Fig 4.3 selecting $v_{dinp} = 1.62 \text{ m/s}$, after that the energy need is the lowest.

When the speed is fixed, the smaller the acceleration is, the better the energy efficiency is [2]. However, when the throughput is fixed (the moving time is the given value), the bigger the acceleration is and the better the energy efficiency is and then the speed is chosen by the figure of the given compartment.

4.2.2 Lifting unit

The energy need does not depend on the speed (v_{linp}) and the acceleration (a_{linp}) of the lifting unit [2]. Therefore, the kinematic parameters of the lifting unit are chosen to suit with the driving time of the driving unit that all lifting and driving units simultaneously

arrive at the destination to reduce the machine parts' wear and to get the best energy efficiency by the required throughput of the vehicle.

The relationship between the lifting unit speed and the lifting time (t_{lift}) is established when the acceleration changes from 1 m/s^2 to 4 m/s^2 corresponding to the heights ($s_{l_{inp}}$) of every compartment, e.g. the relationships between the speed $v_{l_{inp}}$ and the time t_{lift} when $s_{l_{inp}} = 4.96 \text{ m}$ (the eighteenth compartment) are illustrated by Fig. 4.8.

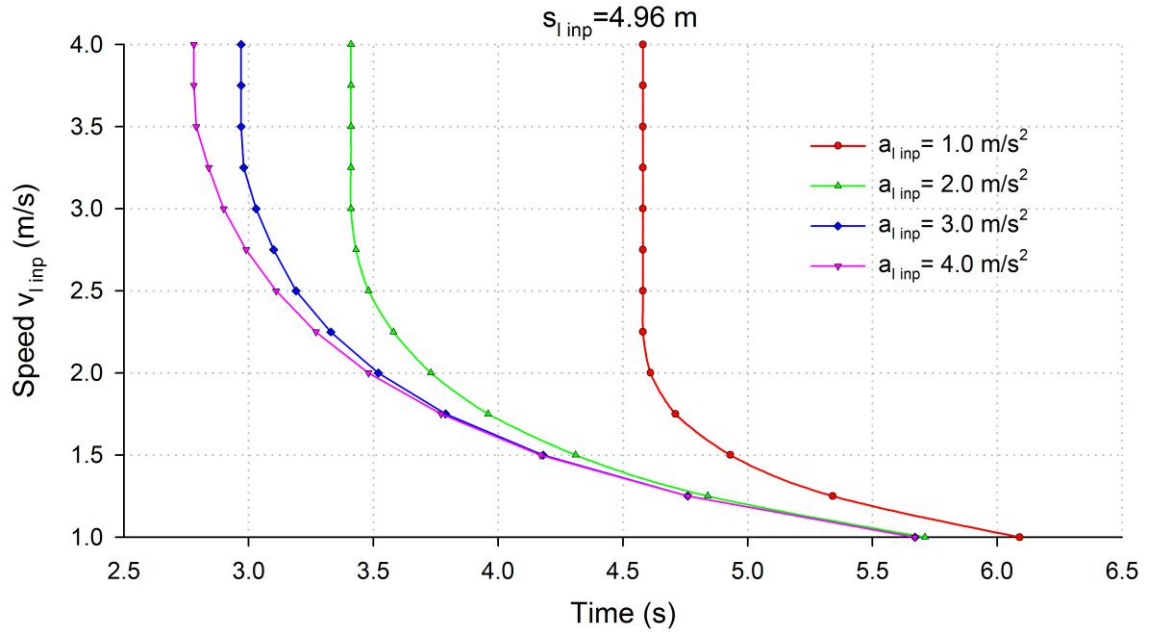

Figure 4.8: Relationship between the lifting unit speed and the lifting time when the height is 4.96 m (the eighteenth compartment).

If the time of the maximum acceleration and speed of the lifting unit is smaller than the driving time of the driving unit, the lifting time is chosen following the driving time to reduce the machine parts' wear of the lifting unit. When the required lifting time is determined, the speed and the acceleration are determined, e.g. when $s_{l_{inp}} = 4.96 \text{ m}$ (Fig. 4.8) and $t_{dri} = 4.5 \text{ s}$, selecting $t_{lift} = 4.5 \text{ s}$, $a_{l_{inp}} = 2 \text{ m/s}^2$ and $v_{l_{inp}} = 1.4 \text{ m/s}$.

If the time of the maximum speed and the maximum acceleration of the lifting unit is bigger than the driving time (the lifting height is greater than the driving distance), the driving time must be chosen following the time of the maximum speed and acceleration of the lifting unit. And then SRV gets the best energy efficiency, e.g. when $s_{l_{inp}} = 4.96 \text{ m}$ (Fig. 4.8) and the required time 2.6s, selecting $a_{l_{inp}} = 4 \text{ m/s}^2$ and $v_{l_{inp}} = 4 \text{ m/s}$ and the chosen real time $t_{dri} = t_{lift} = 2.78 \text{ s}$. After that, the driving time increases and the best energy need in this case is chosen by the lifting time $t_{lift} = 2.78 \text{ s}$.

The energy need of all compartments is determined by the moving time, the acceleration

and the speed of the driving unit and the lifting unit. Based on the figures of these relationships, the best energy need of SRV is shown by the required time in each compartment. The speed and the acceleration are determined following this energy need and the moving time respectively.

4.3 Analyzing average energy need and average throughput of working cycles

The average energy need and the average throughput of the movement strategies of SOC and DOC are determined in whole system and in the ABC zoning. To determine these values, the chaotic storage in whole system and in the ABC zoning (chaotic storage in each zoning) are calculated. After that they are focused on comparison to each other to show the efficiency of each strategy. These values are also the object to assess the effectiveness of the strategies established in the following section.

To clarify the effectiveness of the strategies when they are compared to each other, the dimensions of the considering system are extended from the experimental model at the Institute of Logistics and Material Handling Systems at the Otto-von-Guericke University Magdeburg. It must ensure that the experimental coefficients are not affected to fit the reality. These coefficients depend on the structure of SRV. It means that the storage and retrieval system cannot change vertically when these coefficients are applied to the simulation model. The reason is when the height of the system changes, the structure of the vehicle has to change to suit the system and the coefficients are incorrect in this case. The experimental coefficients must be redefined. The system can be changed horizontally, then the structure of SRV is constant and the simulation results are similar to reality.

For more specific analysis of the storage and retrieval positions, the system is extended horizontally as shown in Fig. 4.9. The system has length of 22.5 m and height of 7.5 m including the engine foundation and the top of SRV. There are two identical racks on the sides, of which SRV moves in the middle. Each rack has 45 compartments horizontally and 21 compartments vertically. The total of two racks is 1890 compartments. Each compartment has a width of 0.5 m and a height of 0.31 m. The loading capacity in the simulation model is 20 kg. The I/O point is located in front of the rack at the height of the second row. The energy recovery is also included in these simulations.

To calculate the average energy need and the average throughput of the movement strategies, the energy need and the moving time of every compartment in SOC and DOC must be determined. It means that, the simulation models of SOC and DOC in this case must be presented. The simulation model of SOC are extended from the simulation model in Section 3 and a simulation model of DOC developed from the SOC's simulation model simulates the kinematic parameters, the power, the energy need and the moving time of the driving unit and the lifting unit and the energy recovery as well which are presented as below.

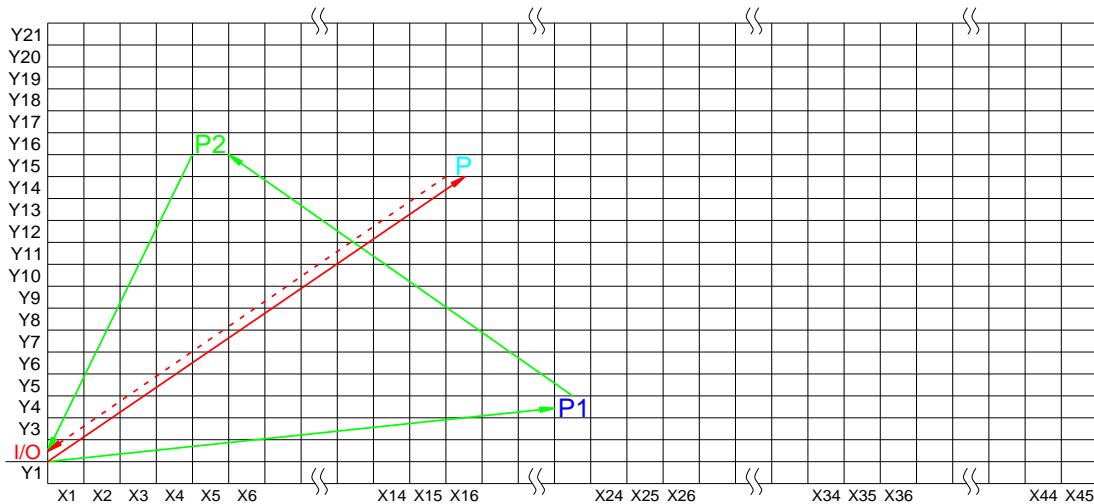

Figure 4.9: Position of the storage and retrieval compartments.

4.3.1 Simulation model of the double operation cycle

In DOC, SRV moves from input point (I) to the storage compartment (P1), then to the retrieval compartment (P2) and ends at output point (O) (Fig. 4.9). The computational formulas of the kinematic parameters, the power, the energy need, the working cases and the experimental coefficients of SRV in every distance of DOC are taken as in the simulation model of SOC.

The input parameters of the simulation model include the size and the positions of the storage and retrieval compartments; the requirement of the speed, the acceleration and the jerk of the driving unit and the lifting unit; the mass of UL; the parameters of SRV consist of the mass of SRV and the lifting unit, the diameter of the wheel, the diameter of the wheel gudgeon; the experimental coefficients of the driving unit and the lifting unit.

The results of the simulation model consist of simulating the driving and lifting distance, the speed, the acceleration and the consumption power by the driving and lifting time from the input point to the storage compartment and then to the retrieval compartment and end at the output point; simulating the recovery power of the driving unit when the vehicle is deceleration or braking; simulating the recovery power of the lifting unit when it lowers the unit load; determining the total energy need and the total moving time when SRV moves from input point to output point with every input value of the speed and the acceleration.

The working time of any DOC is determined by the sum of the greater working time of the driving unit and the lifting unit in each distance and the time of picking goods into and out of SRV ($t_{in/out}$) (Eq. (4.1)). Equation (4.2) to calculate the energy need of any DOC including the energy recovery, it is the result of the total energy need in all the working distances of the units and the energy need of picking goods into and out of the load handing device ($E_{in/out}$).

$$t_{DC}[s]=\text{Max}\{t_{driIP1};t_{liftIP1}\}+\text{Max}\{t_{driP1P2};t_{liftP1P2}\}+\text{Max}\{t_{driP2O};t_{liftP2O}\}+4\cdot t_{in/out} \quad (4.1)$$

$$E_{DC}[kWs]=E_{driIP1}+E_{liftIP1}+E_{driP1P2}+E_{liftP1P2}+E_{driP2O}+E_{liftP2O}+4\cdot E_{in/out} \quad (4.2)$$

4.3.2 Theoretical basis for determining the average values

When the chaotic storage is chosen, the average values of the moving time, the throughput and the energy need in SOC and DOC are determined by each case. After that, the simulation models to calculate the average values of these cycles are developed from the simulation model of the original SOC and from the theoretical basis for determining the average values.

- *The vehicle moves with chaotic storage in whole system of the single operation cycle*

In SOC, the vehicle moves from input point (I) to the storage or retrieval compartment (P) and ends at output point (O) (Fig. 4.9). The working time of any SOC (t_{SC}) is determined by the greater working time of the driving unit and the lifting unit, Eq. (4.3). The energy need of any SOC (E_{SC}) is the result of the total energy need of the units including the energy recovery, Eq. (4.4). The average working time per unit load in whole system $\overline{t_{SC}}$ is determined from the arithmetic mean of random time values and calculated by Eq. (4.5). The average throughput per hour $\overline{Q_{SC}}$ is derived from the average working time, Eq. (4.6). Equation (4.7) shows that the average energy need per unit load $\overline{E_{SC}}$ is calculated from the arithmetic mean of random energy values. The average energy need per hour of SRV $\overline{E_{SC h}}$ is given by Eq. (4.8).

$t_{dri} = t_{driIP} = t_{driPO}$: The driving time of the driving unit on one distance

$t_{lift} = t_{liftIP} = t_{liftPO}$: The lifting time of the lifting unit on one distance

$t_{in/out}$: The time of picking goods into or out of SRV

E_{dri} : The energy need of the driving unit on one distance, including the positive and negative energy

$E_{lifttot}$: The energy need of the lifting unit in whole working cycle, including the positive energy of lifting process and the negative energy of lowering process

$E_{in/out}$: The energy need of picking goods into or out of the load handling device

$$t_{SC}[s]=2\cdot \text{Max}\{t_{dri};t_{lift}\}+2\cdot t_{in/out} \quad (4.3)$$

$$E_{SC}[kWs]=2\cdot E_{dri}+E_{lifttot}+2\cdot E_{in/out} \quad (4.4)$$

$$\overline{t_{SC}}\left[\frac{s}{UL}\right]=\frac{\sum_{i=1}^n t_{SCi}}{n} \quad (4.5)$$

$$\overline{Q_{SC}}\left[\frac{UL}{h}\right] = \frac{3600}{\overline{t_{SC}}\left[\frac{s}{UL}\right]} \quad (4.6)$$

$$\overline{E_{SC}}\left[\frac{kWs}{UL}\right] = \frac{\sum_{i=1}^n E_{SCi}}{n} \quad (4.7)$$

$$\overline{E_{SCh}}\left[\frac{kWh}{h}\right] = \frac{\overline{E_{SC}}\left[\frac{kWs}{UL}\right] \cdot \overline{Q_{SC}}\left[\frac{UL}{h}\right]}{3600} \quad (4.8)$$

- *The vehicle moves in the ABC zoning of the single operation cycle*

When SRV moves in the ABC zoning, the chaotic storage is chosen in each zone. The average working time per unit load is calculated from the sum of the arithmetic mean of random time values in each zone multiplied by the goods access frequency in respective zone, Eq. (4.9). The average throughput per hour is determined by Equation (4.10). The average energy need per unit load is the sum of the arithmetic mean of random energy values in each zone multiplied by the goods access frequency in respective zone, Eq. (4.11). The average energy need per hour of SRV is given by Equation (4.12).

$$\overline{t_{SCABC}}\left[\frac{s}{UL}\right] = \frac{\sum_{i=1}^n t_{SCAi}}{n} \cdot \rho_A + \frac{\sum_{i=1}^n t_{SCBi}}{n} \cdot \rho_B + \frac{\sum_{i=1}^n t_{SCCi}}{n} \cdot \rho_C \quad (4.9)$$

$$\overline{Q_{SCABC}}\left[\frac{UL}{h}\right] = \frac{3600}{\overline{t_{SCABC}}\left[\frac{s}{UL}\right]} \quad (4.10)$$

$$\overline{E_{SCABC}}\left[\frac{kWs}{UL}\right] = \frac{\sum_{i=1}^n E_{SCAi}}{n} \cdot \rho_A + \frac{\sum_{i=1}^n E_{SCBi}}{n} \cdot \rho_B + \frac{\sum_{i=1}^n E_{SCCi}}{n} \cdot \rho_C \quad (4.11)$$

$$\overline{E_{SCABC h}}\left[\frac{kWh}{h}\right] = \frac{\overline{E_{SCABC}}\left[\frac{kWs}{UL}\right] \cdot \overline{Q_{SCABC}}\left[\frac{UL}{h}\right]}{3600} \quad (4.12)$$

- *The vehicle moves with chaotic storage in whole system of the double operation cycle*

In DOC (Fig. 4.9), when the parameters are calculated, the storage and retrieval compartments are chosen randomly in the system. The average working time per unit load of DOC is determined by Equation (4.13). The average throughput per hour is derived from the average working time and shown by Equation (4.14). The average energy need per unit load is calculated by Equation (4.15). The average energy need per hour of SRV is given by Equation (4.16).

$$\overline{t_{DC}}\left[\frac{s}{UL}\right]=\frac{\sum_{i=1}^n t_{DCi}}{2 \cdot n} \quad (4.13)$$

$$\overline{Q_{DC}}\left[\frac{UL}{h}\right]=2 \cdot \frac{3600}{\overline{t_{DC}}\left[\frac{s}{2UL}\right]} = \frac{3600}{\overline{t_{DC}}\left[\frac{s}{UL}\right]} \quad (4.14)$$

$$\overline{E_{DC}}\left[\frac{kWs}{UL}\right]=\frac{\sum_{i=1}^n E_{DCi}}{2 \cdot n} \quad (4.15)$$

$$\overline{E_{DC h}}\left[\frac{kWh}{h}\right]=\frac{\overline{E_{DC}}\left[\frac{kWs}{UL}\right] \cdot \overline{Q_{DC}}\left[\frac{UL}{h}\right]}{3600} \quad (4.16)$$

- *The vehicle moves in the ABC zoning of the double operation cycle*

When SRV moves in the ABC zoning of DOC, the storage and retrieval compartments are chosen randomly in each zone. The average working time per unit load is determined by Equation (4.17) and is the result of the sum of the arithmetic mean of random time values in each zone multiplied by the goods access frequency in respective zone. Equation (4.18) presents the average throughput per hour of SRV. The average energy need per unit load in the ABC zoning is the sum of the arithmetic mean of random energy values in each zone multiplied by the goods access frequency in respective zone and it is shown by Equation (4.19). The average energy need per hour of SRV is given by Equation (4.20).

$$\overline{t_{DC ABC}}\left[\frac{s}{UL}\right]=\frac{\sum_{i=1}^n t_{DCAi}}{2 \cdot n} \cdot \rho_A + \frac{\sum_{i=1}^n t_{DCBi}}{2 \cdot n} \cdot \rho_B + \frac{\sum_{i=1}^n t_{DCCi}}{2 \cdot n} \cdot \rho_C \quad (4.17)$$

$$\overline{Q_{DC ABC}}\left[\frac{UL}{h}\right]=\frac{3600}{\overline{t_{DC ABC}}\left[\frac{s}{UL}\right]} \quad (4.18)$$

$$\overline{E_{DC ABC}}\left[\frac{kWs}{UL}\right]=\frac{\sum_{i=1}^n E_{DCAi}}{2 \cdot n} \cdot \rho_A + \frac{\sum_{i=1}^n E_{DCBi}}{2 \cdot n} \cdot \rho_B + \frac{\sum_{i=1}^n E_{DCCi}}{2 \cdot n} \cdot \rho_C \quad (4.19)$$

$$\overline{E_{DC ABC h}}\left[\frac{kWh}{h}\right]=\frac{\overline{E_{DC ABC}}\left[\frac{kWs}{UL}\right] \cdot \overline{Q_{DC ABC}}\left[\frac{UL}{h}\right]}{3600} \quad (4.20)$$

4.3.3 Influence of the movement strategies

$X_{00}Y_{02}$ is chosen to be the I/O position by the analysis of influencing of the I/O positions in Section 2.5.2.1 and the common usage conditions in reality.

The energy need does not depend on the kinematic parameters of the lifting unit. Therefore, the kinematic parameters of the lifting unit are chosen at the maximum values ($v_{l_{imp}} = v_{l_{max}} = 4 \text{ m/s}$ and $a_{l_{imp}} = a_{l_{max}} = 4 \text{ m/s}^2$). After that, the lifting unit affects the total working time of SRV a little bit.

When I/O point is $X_{00}Y_{02}$, the ABC zoning is determined by Equation (4.21) [70]. The ratio of three zones is equally divided by 1/3: 1/3: 1/3. Due to the speed by vertical $v_y = v_{l_{max}} = 4 \text{ m/s}$, the speed by horizontal $v_x \leq 5 \text{ m/s}$ and the system length is nearly four times as great as the height so the system is divided horizontally into three equal parts with all values of the required driving unit speed (Fig. 4.10).

$$y = \frac{v_y}{v_x} \cdot x \quad (4.21)$$

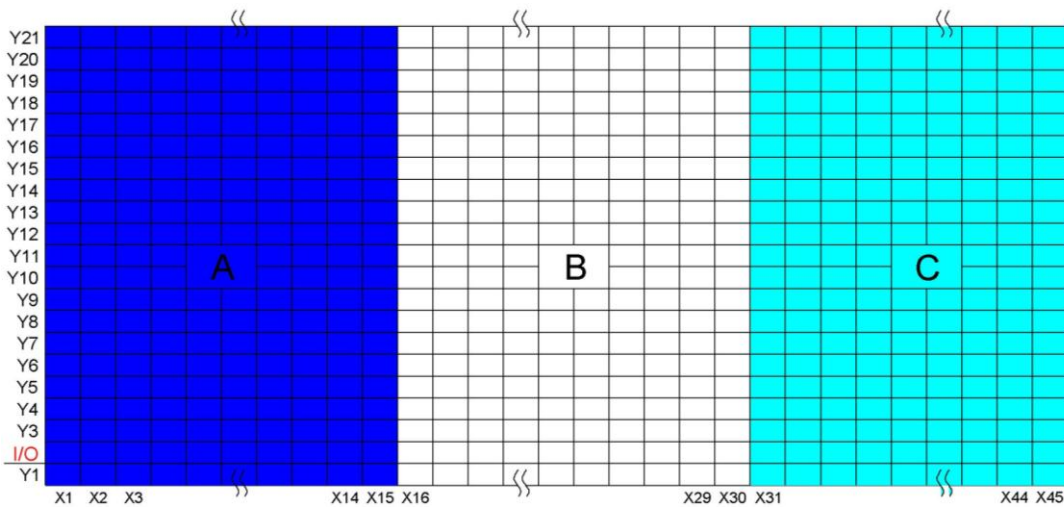

Figure 4.10: Division of the ABC zoning in the storage and storage system.

Regarding to Section 4.2.1 for each distance and the required time, the bigger the acceleration is and the smaller the energy need is. Besides, the required time is determined by the required throughput. Therefore, the driving unit acceleration in this Section is chosen $a_{d_{imp}} = a_{d_{max}} = 3 \text{ m/s}^2$ to achieve the best energy efficiency.

From the theoretical formulas to determine the average values and the results received from the simulation models of SOC and DOC, the average values of the throughput and energy need in the operation cycles are determined in Fig. 4.11 when the acceleration $a_{d_{imp}} = 3 \text{ m/s}^2$ and the driving unit speed increases from 2 m/s to 5 m/s.

In all cases from Fig. 4.11, when the speed increases from 2 m/s to 5 m/s, the average throughput per hour and the average energy need per unit load also increase. However, the average energy need increases significantly compared to the average throughput and it is specified as follows:

When SRV moves in SOC with the chaotic storage in whole system and the driving unit speed increases from 2 m/s to 5 m/s, the average throughput ($\overline{Q_{SC}}$) increases 26.6% and the average energy need ($\overline{E_{SC}}$) increases 55.7%.

When SRV moves in SOC with the chaotic storage in ABC zoning and the driving unit speed increases from 2 m/s to 5 m/s, the average throughput ($\overline{Q_{SCABC}}$) increases 11.2% and the average energy need ($\overline{E_{SCABC}}$) increases 39%.

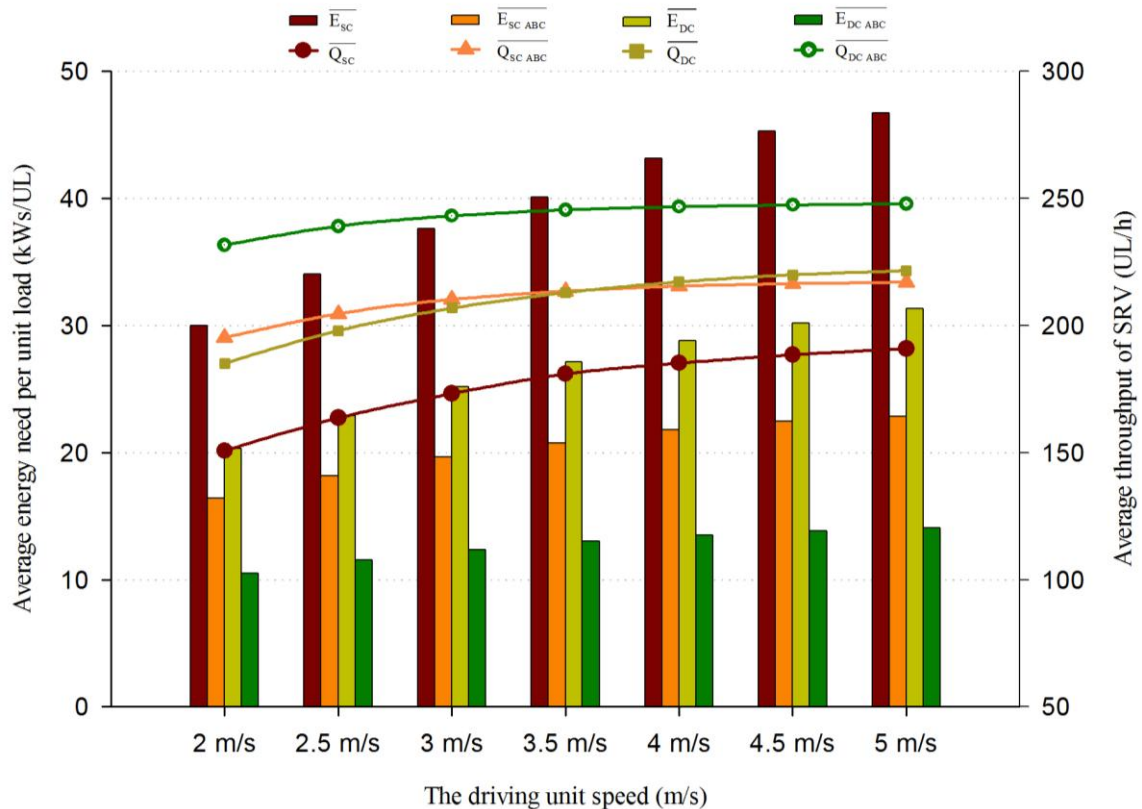

Figure 4.11: Average energy need per unit load and average throughput per hour for chaotic storage with $v_{inp} = 4 \text{ m/s}$ and $a_{inp} = 4 \text{ m/s}^2$.

When SRV moves in DOC with the chaotic storage in whole system and the driving unit speed increases from 2 m/s to 5 m/s, the average throughput ($\overline{Q_{DC}}$) increases 19.7% and the average energy need ($\overline{E_{DC}}$) increases 54.2%.

When SRV moves in DOC with the chaotic storage in ABC zoning and the driving unit speed increases from 2 m/s to 5 m/s, the average throughput ($\overline{Q_{DCABC}}$) increases 7% and the average energy need ($\overline{E_{DCABC}}$) increases 34.3%.

For the above results, when SRV moves in ABC zoning, the speed increases from 2 m/s to 5 m/s and then the average throughput efficiency of both SOC and DOC is low (7-11.2%)

and the average energy need increases quite highly (34.3-39%). When the chaotic storage in whole system is performed, the speed increases from 2 m/s to 5 m/s and then the average throughput of both SOC and DOC increases significantly (19.7-26.6%) and the average energy need increases very highly (54.2-55.7%).

After the average values of each case are determined, the efficient percentages of the average throughput and the average energy need among the cases are compared to each other for the best orientation when the system is operated. The compared values are indicated from Table 4.3 to Table 4.7 and the compared percentages are illustrated in Figure 4.12.

$v_{d\text{inp}}$ (m/s)	\overline{Q}_{SC} (UL/h)	\overline{Q}_{DC} (UL/h)	$\overline{\Delta Q}_{DC-SC}$ (%)	$\overline{\Delta t}_{DC-SC\text{mo}}$ (%)	\overline{E}_{SC} (kW/s/UL)	\overline{E}_{DC} (kW/s/UL)	$\overline{\Delta E}_{DC-SC}$ (%)
2.0	150.7	185.0	22.8	31.9	30.0	20.3	-32.3
2.5	163.6	198.0	21.0	31.8	34.1	22.9	-32.8
3.0	173.2	206.8	19.4	31.3	37.6	25.2	-33.1
3.5	181.0	212.9	17.7	30.2	40.1	27.1	-32.3
4.0	185.2	217.0	17.2	30.3	43.1	28.9	-33.3
4.5	188.5	219.9	16.7	30.0	45.3	30.1	-33.4
5.0	190.8	221.6	16.1	29.5	46.7	31.3	-32.9

Table 4.3: Comparison of average throughput per hour and average energy need per unit load for chaotic storage in whole system of SOC and DOC.

$v_{d\text{inp}}$ (m/s)	$\overline{Q}_{SC\text{ABC}}$ (UL/h)	$\overline{Q}_{DC\text{ABC}}$ (UL/h)	$\overline{\Delta Q}_{DC\text{ABC}-SC\text{ABC}}$ (%)	$\overline{E}_{SC\text{ABC}}$ (kW/s/UL)	$\overline{E}_{DC\text{ABC}}$ (kW/s/UL)	$\overline{\Delta E}_{DC\text{ABC}-SC\text{ABC}}$ (%)
2	195.2	231.7	18.6	16.4	10.5	-36.0
2.5	204.6	239.1	16.9	18.2	11.5	-36.5
3	210.2	243.1	15.6	19.6	12.4	-37.0
3.5	213.5	245.5	15.0	20.7	13.0	-37.1
4	215.4	246.7	14.5	21.8	13.5	-37.9
4.5	216.4	247.4	14.3	22.4	13.8	-38.3
5	217.0	247.8	14.2	22.8	14.1	-38.4

Table 4.4: Comparison of average throughput per hour and average energy need per unit load for chaotic storage in ABC zoning of SOC and DOC.

v_{dinp} (m/s)	\overline{Q}_{SC} (UL/h)	$\overline{Q}_{SC\ ABC}$ (UL/h)	$\overline{\Delta Q}_{SC_ABC-SC}$ (%)	\overline{E}_{SC} (kW/s/UL)	$\overline{E}_{SC\ ABC}$ (kW/s/UL)	$\overline{\Delta E}_{SC_ABC-SC}$ (%)
2.0	150.7	195.2	29.5	30.0	16.4	-45.3
2.5	163.6	204.6	25.0	34.1	18.2	-46.7
3.0	173.2	210.2	21.4	37.6	19.6	-47.8
3.5	181.0	213.5	18.0	40.1	20.7	-48.2
4.0	185.2	215.4	16.3	43.1	21.8	-49.5
4.5	188.5	216.4	14.8	45.3	22.4	-50.4
5.0	190.8	217.0	13.7	46.7	22.8	-51.1

Table 4.5: Comparison of average throughput per hour and average energy need per unit load for chaotic storage in whole system and in ABC zoning of SOC.

v_{dinp} (m/s)	\overline{Q}_{DC} (UL/h)	$\overline{Q}_{DC\ ABC}$ (UL/h)	$\overline{\Delta Q}_{DC_ABC-DC}$ (%)	\overline{E}_{DC} (kW/s/UL)	$\overline{E}_{DC\ ABC}$ (kW/s/UL)	$\overline{\Delta E}_{DC_ABC-DC}$ (%)
2.0	185.0	231.7	25.1	20.3	10.5	-48.3
2.5	198.0	239.1	20.8	22.9	11.5	-49.6
3.0	206.8	243.1	17.5	25.2	12.4	-50.9
3.5	212.9	245.5	15.3	27.1	13.0	-51.9
4.0	217.0	246.7	13.6	28.9	13.5	-53.0
4.5	219.9	247.4	12.5	30.1	13.8	-54.1
5.0	221.6	247.8	11.9	31.3	14.1	-55.1

Table 4.6: Comparison of average throughput per hour and average energy need per unit load for chaotic storage in whole system and in ABC zoning of DOC.

v_{dinp} (m/s)	\overline{Q}_{SC} (UL/h)	$\overline{Q}_{DC\ ABC}$ (UL/h)	$\overline{\Delta Q}_{DC_ABC-SC}$ (%)	\overline{E}_{SC} (kW/s/UL)	$\overline{E}_{DC\ ABC}$ (kW/s/UL)	$\overline{\Delta E}_{DC_ABC-SC}$ (%)
2.0	150.7	231.7	53.7	30.0	10.5	-65.0
2.5	163.6	239.1	46.1	34.1	11.5	-66.3
3.0	173.2	243.1	40.4	37.6	12.4	-67.0
3.5	181.0	245.5	35.6	40.1	13.0	-67.6
4.0	185.2	246.7	33.2	43.1	13.5	-68.7
4.5	188.5	247.4	31.2	45.3	13.8	-69.5
5.0	190.8	247.8	29.9	46.7	14.1	-69.8

Table 4.7: Comparison of average throughput per hour and average energy need per unit load for chaotic storage in whole system of SOC and in ABC zoning of DOC.

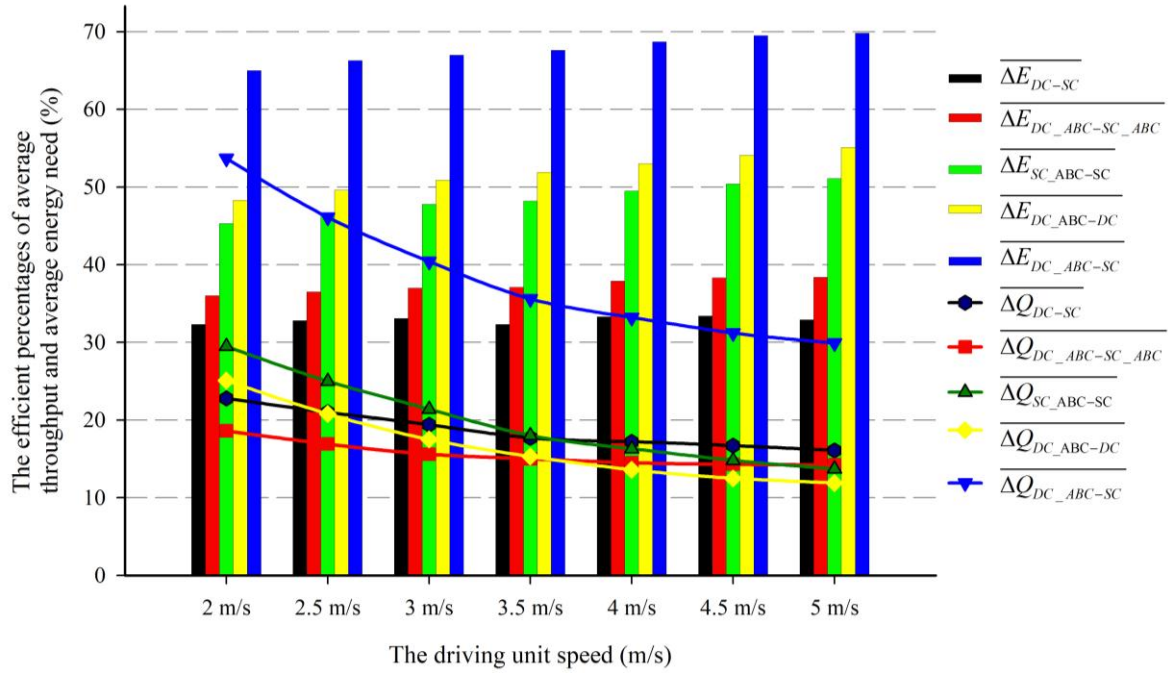

Figure 4.12: Comparison the efficient percentages of average throughput per hour and average energy need per unit load for chaotic storage in the pairs of all cases.

From Figure 4.12, the efficiencies are synthesized when the cases are compared to each other and the driving unit speed increases from 2 m/s to 5 m/s:

The efficient percentages of the average energy need of the ABC zoning compared to the non-zoning are very high in both movement strategies of SOC and DOC. These efficiencies increase more about 6-7% when the speed increases from 2 m/s to 5 m/s, e.g. (Fig. 4.12) the efficient percentage of the energy need in SOC increases from 45.3% to 51.1% and increases from 48.3% to 55.1% in DOC. When the speed increases from 2 m/s to 5 m/s, the efficient percentages of the average throughput of the ABC zoning compared to non-zoning deduct about 13-15% in both movement strategies, e.g. the efficient percentage of throughput in SOC decreases from 29.5% to 13.7% and decreases from 25.1% to 11.9% in DOC.

In particular, the efficient percentages of the average energy need and the average throughput of DOC in the ABC zoning compared to SOC of non-zoning are very high, e.g. when the speed increases from 2 m/s to 5 m/s, the energy efficiency increases from 65% to 69.8% and the throughput efficiency decreases from 53.7% to 29.9%. It means that, the energy efficiency is very high and changes a little bit (4.8%) and the throughput efficiency is significantly reduced about 23.8%.

When the speed increases in non-zoning and in ABC zoning, the efficient percentages of the average energy need of DOC compared to SOC change slightly about 1-2%, e.g. the efficient percentage oscillates from 32% to 33% in non-zoning and oscillates from 36% to 38.4% in ABC zoning. Besides, the efficient percentages of the average throughput

decrease significantly, e.g. the efficient percentage decreases from 22.8% to 16.1% in non-zoning and decreases from 18.6% to 14.2% in ABC zoning. To sum up, when the speed increases from 2 m/s to 5 m/s, the efficient percentage of the energy need changes slightly about 1-2% and the efficient percentage of the throughput decreases significantly (5-7%).

The most general assessments of the effectiveness of the movement strategies are shown after the data in Fig. 4.12 is analyzed. The combinations of SOC and DOC are considered to increase the operation efficiency and reduce the energy need of the system.

4.3.4 Combination of the single operation cycle and double operation cycle

In reality, SOC and DOC can be combined in the operating processes to achieve the high efficiency of the throughput and the energy need. These combinations depend on the speed and the required throughput. The movement percentage of DOC (ρ_{DC}) is determined by Equation (4.22). From the movement percentage of DOC and the average working time of SOC and DOC, the average number of the operation cycles per hour (\overline{SC}_{Combi} and \overline{DC}_{Combi}) in combination is shown by Equation (4.24). The average throughput per hour of the combination (\overline{Q}_{Combi}) is derived from the average moving times and the movement percentage of DOC, presented by Equation (4.25).

In Equation (4.26), the average energy need per unit load of combination (\overline{E}_{Combi}) is calculated from the average energy need of SOC and DOC. The average energy need per hour in the storage combination of SRV ($\overline{E}_{Combi h}$) is shown by Equation (4.27) to indicate practical energy consumption.

$$\rho_{DC}[\%] = \frac{\overline{DC}_{Combi}}{\overline{SC}_{Combi} + \overline{DC}_{Combi}} \quad (4.22)$$

$$\overline{t}_{DC} \left[\frac{s}{2UL} \right] = \overline{t}_{DC} = 2 \cdot \overline{t}_{DC} \left[\frac{s}{UL} \right] \quad (4.23)$$

$$\begin{cases} \overline{DC}_{Combi} = \frac{\rho_{DC}}{1 - \rho_{DC}} \cdot \overline{SC}_{Combi} \\ \overline{t}_{SC} \cdot \overline{SC}_{Combi} + \overline{t}_{DC} \cdot \overline{DC}_{Combi} = 3600 \end{cases} \Rightarrow \begin{cases} \overline{SC}_{Combi} = \frac{3600}{\frac{\overline{t}_{SC}}{1 - \rho_{DC}} + \overline{t}_{DC} \cdot \frac{\rho_{DC}}{1 - \rho_{DC}}} = \frac{3600 \cdot (1 - \rho_{DC})}{\overline{t}_{SC} \cdot (1 - \rho_{DC}) + \overline{t}_{DC} \cdot \rho_{DC}} \\ \overline{DC}_{Combi} = \frac{\rho_{DC}}{1 - \rho_{DC}} \cdot \frac{3600 \cdot (1 - \rho_{DC})}{\overline{t}_{SC} \cdot (1 - \rho_{DC}) + \overline{t}_{DC} \cdot \rho_{DC}} = \frac{3600 \cdot \rho_{DC}}{\overline{t}_{SC} \cdot (1 - \rho_{DC}) + \overline{t}_{DC} \cdot \rho_{DC}} \end{cases} \quad (4.24)$$

$$\overline{Q_{Combi}} \left[\frac{UL}{h} \right] = \overline{Q_{SCCombi}} + \overline{Q_{DCCombi}} = \overline{SC_{Combi}} + 2 \cdot \overline{DC_{Combi}}$$

$$\overline{Q_{Combi}} \left[\frac{UL}{h} \right] = \frac{3600 \cdot (1 + \rho_{DC})}{t_{SC} \cdot (1 - \rho_{DC}) + t_{DC} \cdot \rho_{DC}} \quad (4.25)$$

$$\overline{E_{Combi}} \left[\frac{kWs}{UL} \right] = \frac{\overline{SC_{Combi}} \cdot \overline{E_{SC}} + 2 \cdot \overline{DC_{Combi}} \cdot \overline{E_{DC}}}{\overline{Q_{Combi}}} \quad (4.26)$$

$$\overline{E_{Combi}} \left[\frac{kWh}{h} \right] = \frac{\overline{Q_{Combi}} \left[\frac{UL}{h} \right] \cdot \overline{E_{Combi}} \left[\frac{kWs}{UL} \right]}{3600} = \frac{\overline{SC_{Combi}} \cdot \overline{E_{SC}} + 2 \cdot \overline{DC_{Combi}} \cdot \overline{E_{DC}}}{3600} \quad (4.27)$$

From average moving time and average energy need per unit load of SOC and DOC, the specific values of the average throughput and the average energy need of each storage combination are determined by the movement percentage of DOC and the required speed of the driving unit. The average throughput per unit load is shown by Fig. 4.13 with variation of the driving unit speeds and the movement percentages of DOC for chaotic storage, the transferring point X00Y02 and the kinematic parameters of the lifting unit $v_{inp} = 4 \text{ m/s}$, $a_{inp} = 4 \text{ m/s}^2$. The average energy need per unit load is determined by Fig. 4.14 with variation of the driving unit speeds and the movement percentage for chaotic storage. The energy consumption per hour is shown by Fig. 4.15 with variation of the driving unit speeds and the movement percentages for chaotic storage.

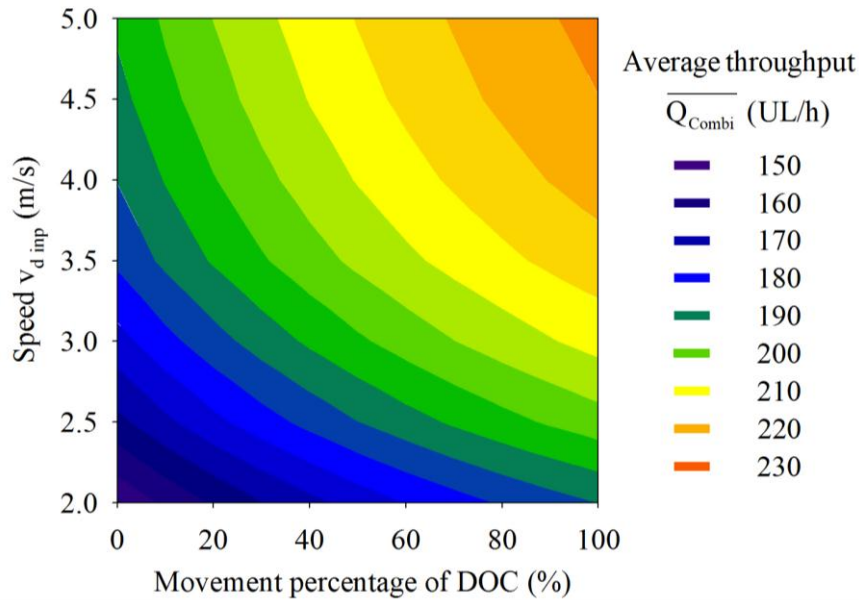

Figure 4.13: Average throughputs per hour with variation of the driving unit speeds and the movement percentages of DOC for chaotic storage, transferring point X00Y02 and

$$v_{inp} = 4 \text{ m/s}, a_{inp} = 4 \text{ m/s}^2.$$

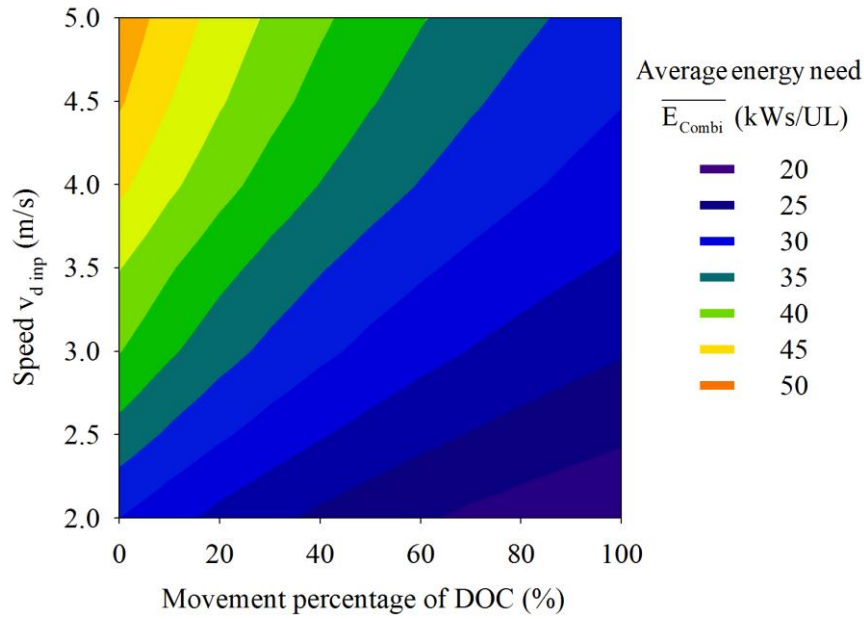

Figure 4.14: Average energy need per unit load with variation of the driving speeds and the movement percentages of DOC for chaotic storage, transferring point X00Y02 and

$$v_{l\text{inp}} = 4 \text{ m/s}, a_{l\text{inp}} = 4 \text{ m/s}^2.$$

Based on the required throughput and the required movement percentage of DOC in reality, the required speed of the driving unit are determined by Figure 4.13 and are linked to Figure 4.14 to achieve the best energy efficiency.

When the required throughput is constant and the movement percentage of DOC increases, the driving unit speed and the average energy need decrease (Fig. 4.13 and 4.14), e.g. for the required throughput $\overline{Q}_{\text{Combi}} = 190 \text{ (UL/h)}$, when the movement percentage of DOC is chosen by 20%, the average speed is chosen by 3.5 m/s and the energy consumption is 36 (kW/UL). However, when the movement percentage of DOC is chosen by 40%, the average speed of the driving unit is chosen by 3 m/s and the energy consumption is 30 (kW/UL). It means that the average energy need per unit load decreases 16.7% when the movement percentage of DOC increases from 20% to 40%.

When the driving unit speed is constant and the movement percentage of DOC increases, the average throughput increases and the average energy need decreases, e.g. for the driving unit speed $v_{d\text{inp}} = 3 \text{ m/s}$, when the movement percentage of DOC is chosen by 20%, the average throughput $\overline{Q}_{\text{Combi}} = 183 \text{ (UL/h)}$ and the average energy need $\overline{E}_{\text{Combi}} = 33.5 \text{ (kW/LU)}$. When the movement percentage of DOC is chosen by 40%, the average throughput $\overline{Q}_{\text{Combi}} = 191 \text{ (UL/h)}$ and the average energy need $\overline{E}_{\text{Combi}} = 30.5 \text{ (kW/LU)}$.

When the movement percentage of DOC is constant and the driving unit speed increases, the average throughput and the average energy need of the system increase, e.g. the movement percentage of DOC is 60%: when the driving unit speed $v_{dinp} = 3\text{ m/s}$ and then $\overline{Q}_{Combi} = 197\text{ (UL/h)}$ and $\overline{E}_{Combi} = 28.3\text{ (kWs/LU)}$. However, when the driving unit speed $v_{dinp} = 4\text{ m/s}$ and then $\overline{Q}_{Combi} = 208\text{ (UL/h)}$ and $\overline{E}_{Combi} = 32.4\text{ (kWs/LU)}$. It means that the average throughput increases 5.6% and the average energy need per unit load increases 14.5% when the movement percentage of DOC is constant 60%.

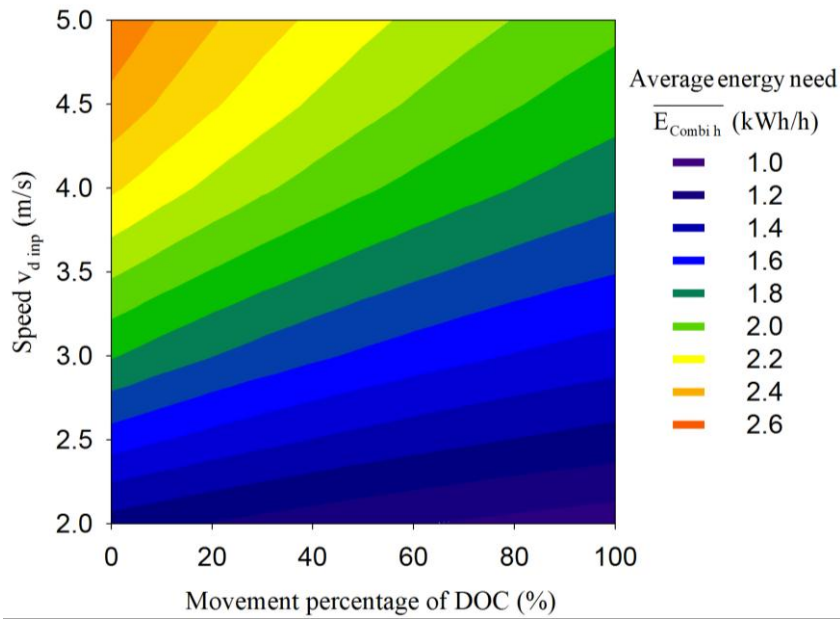

Figure 4.15: Average energy consumption per hour with variation of driving speeds and movement percentages of DOC for chaotic storage, transferring point X00Y02,

$$v_{linp} = 4\text{ m/s}, a_{linp} = 4\text{ m/s}^2.$$

The average energy consumption per hour of SRV is shown by Figure 4.15 after the driving unit speed and the movement percentage of DOC are determined. As a result, the practical energy consumption of the system is determined more specifically.

In current practice, when SOC and DOC are combined, the maximum movement percentage of DOC is often applied about 20% [23]. The movement percentage of DOC should be chosen as large as possible to achieve the best energy efficiency by the required throughput.

The above assessments only aim to increase the efficiencies of the average throughput and the average energy need of the system. They do not reflect the direct controlling method for each specific case to increase the efficiencies of the system. The method of selecting the storage and retrieval positions of DOC is analyzed in detail in the following Chapters.

Chapter 5

Efficiencies of choosing the storage and retrieval positions in the double operation cycle

The logical choice between a storage position and a retrieval position in DOC is to reduce the energy need and the moving time of an SRV. To find the logical choice between the storage and retrieval positions in the system for DOC, the energy need and the moving time of SRV in DOC are compared to the ones in SOC when the storage and retrieval positions are changed in every compartment of the system.

Although there are many studies on the moving time and the energy need of the system mentioned in Chapter 2, the distance (altitude, length) between the storage and retrieval positions has not been specifically analyzed to reduce the energy need and the moving time in DOC when the storage and retrieval positions are chosen in pairs.

When the storage and retrieval vehicle moves in DOC, some cases are determined to choose the pairs of the storage and retrieval positions. The energy need and the moving time in each case are compared to the ones of the individual compartments of SOC to find the appropriate method for DOC. The compartments denoted from a1 to a25 are determined in Fig. 5.1 to better illustrate the logical choice of pairs in DOC.

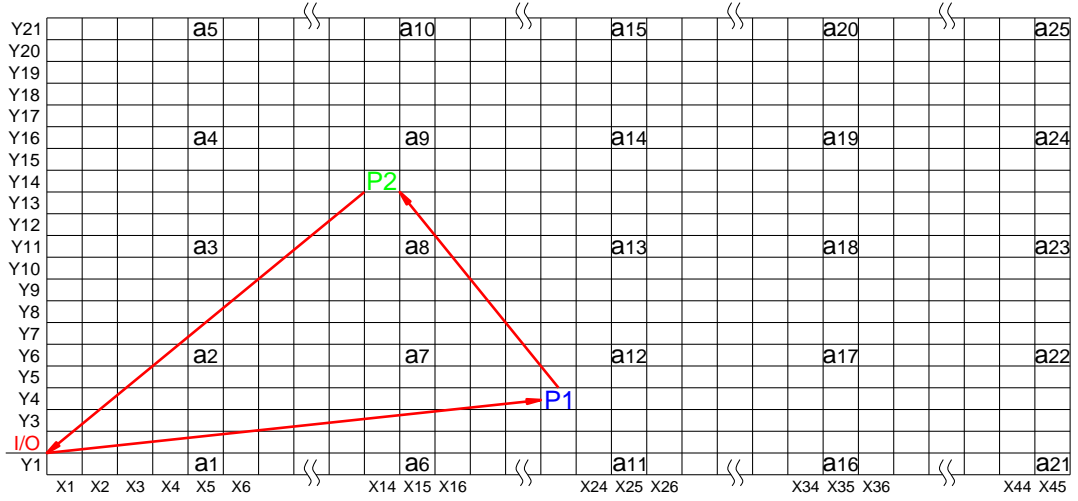

Figure 5.1: Some specific positions of the storage and retrieval system.

5.1 Energy need and the working time of the operation cycles

The energy need and the working time of SRV consist of the driving unit, the lifting unit and the load handling device. The load handling device only works when it picks goods into or out at I/O point or at the compartments. The energy recovery is included in total energy need and achieved during the deceleration process of the driving unit or the lowering process of the lifting unit.

When SRV performs both of storage (P1) and retrieval (P2) and the time of picking goods into is equal to the time of picking goods out of SRV ($t_{in/out}$), the total working time (t_{TSC}) of the SRV in SOCs is calculated by Equation (5.1). Total working time (t_{DC}) in DOC is calculated by Equation (5.2). When SRV performs both of storage (P1) and retrieval (P2) and the energy need of picking goods into is equal to the energy need of picking goods out of the load handling device ($E_{in/out}$), the total energy need (E_{TSC}) in SOCs is calculated by Equation (5.4). The energy need (E_{DC}) in DOC is calculated by Equation (5.5).

$$t_{I1} = \text{Max} \{t_{dri IP1}; t_{lift IP1}\}$$

$$t_{I2} = \text{Max} \{t_{dri P1P2}; t_{lift P1P2}\}$$

$$t_{2O} = \text{Max} \{t_{dri P2O}; t_{lift P2O}\}$$

$$t_{TSC} = 2 \cdot t_{I1} + 2 \cdot t_{2O} + 4 \cdot t_{in/out} \quad (5.1)$$

$$t_{DC} = t_{I1} + t_{I2} + t_{2O} + 4 \cdot t_{in/out} \quad (5.2)$$

$$t_{TSC} - t_{DC} = t_{I1} + t_{2O} - t_{I2} \quad (5.3)$$

$$E_{DI1} = E_{d pos IP1} - |E_{d reco IP1}|$$

$$E_{D12} = E_{d_{pos}P1P2} - |E_{d_{reco}P1P2}|$$

$$E_{D2O} = E_{d_{pos}P2O} - |E_{d_{reco}P2O}|$$

$$E_{L11} = E_{l_{pos}IP1} - |E_{l_{reco}IP1}|$$

$$E_{L12} = E_{l_{pos}P1P2} - |E_{l_{reco}P1P2}|$$

$$E_{L2O} = E_{l_{pos}P2O} - |E_{l_{reco}P2O}|$$

$$E_{L1O} = E_{l_{pos}P1O} - |E_{l_{reco}P1O}|$$

$$E_{L12} = E_{l_{pos}IP2} - |E_{l_{reco}IP2}|$$

$$E_{TSC} = 2 \cdot E_{D11} + 2 \cdot E_{D2O} + E_{L11} + E_{L1O} + E_{L12} + E_{L2O} + 4 \cdot E_{in/out} \quad (5.4)$$

$$E_{DC} = E_{D11} + E_{D12} + E_{D2O} + E_{L11} + E_{L12} + E_{L2O} + 4 \cdot E_{in/out} \quad (5.5)$$

$$E_{TSC} - E_{DC} = E_{D11} + E_{D2O} - E_{D12} + E_{L1O} + E_{L12} - E_{L12} \quad (5.6)$$

Saving capacities of the working time ($t_{TSC} - t_{DC}$) and the energy need ($E_{TSC} - E_{DC}$) in DOC compared to the ones in SOC only depend on the driving unit and the lifting unit and they do not depend on the load handling device, referring to Equation (5.3) and (5.6). Therefore, the next steps only consider the energy need and moving time of the driving unit and the lifting unit to find the logical choice of the storage and retrieval positions.

The saving time percentage $PT(\%)$ of DOC compared to the one of SOC is determined by Equation (5.7) and the saving energy percentage $PE(\%)$ is determined by Equation (5.8) or (5.9). Equations (5.7), (5.8) and (5.9) are used to compare the saving ability of the moving time and the energy need of SRV when the storage and retrieval positions are chosen differently.

$$PT(\%) = \frac{t_{11} + t_{2O} - t_{12}}{2 \cdot (t_{11} + t_{2O})} \cdot 100(\%)$$

$$PT(\%) = \left(\frac{1}{2} - \frac{t_{12}}{2 \cdot (t_{11} + t_{2O})} \right) \cdot 100(\%) \quad (5.7)$$

$$PE(\%) = \frac{E_{D11} + E_{D2O} + E_{L1O} + E_{L12} - E_{D12} - E_{L12}}{2 \cdot (E_{D11} + E_{D2O}) + E_{L1O} + E_{L11} + E_{L12} + E_{L2O}} \cdot 100(\%)$$

$$PE(\%) = \frac{1}{2} - \frac{E_{D12} + E_{L12} + \frac{1}{2} \cdot (E_{L11} + E_{L2O} - E_{L1O} - E_{L12})}{2 \cdot (E_{D11} + E_{D2O}) + E_{L1O} + E_{L11} + E_{L12} + E_{L2O}} \cdot 100(\%) \quad (5.8)$$

$$PE(\%) = \left(1 - \frac{E_{D11} + E_{D2O} + E_{D12} + E_{L11} + E_{L2O} + E_{L12}}{2 \cdot (E_{D11} + E_{D2O}) + E_{L1O} + E_{L11} + E_{L12} + E_{L2O}} \right) \cdot 100(\%) \quad (5.9)$$

The efficiencies of choosing the storage and retrieval positions in DOC are determined by the results of the simulation models of SOC and DOC and by the specific analyses.

5.2 Efficiencies of choosing the positions in the double operation cycle

In general, the energy need and the moving time in DOC are saved more than the ones in SOC. The energy need does not depend on the input speed ($v_{l_{inp}}$) and the input acceleration ($a_{l_{inp}}$) of the lifting unit [2]. Therefore, the kinematic parameters of the lifting unit are chosen at the maximum values $v_{l_{inp}} = v_{l_{max}} = 4 \text{ m/s}$ and $a_{l_{inp}} = a_{l_{max}} = 4 \text{ m/s}^2$. After that, the lifting time affects the least to the total working time.

To determine the efficiencies of the positions in DOC, the distance (altitude, length) between the storage and retrieval positions P1P2 is specifically analyzed to reduce the energy need and the moving time in DOC. The positions of P1 and P2 are considered in simple cases and then generalized to have general conclusions.

The below cases are indicated to determine the method of choosing the logical positions in DOC when the energy need and the moving time in DOC are compared with SOC.

5.2.1 When vehicle moves firstly to one of any two defined positions P1 and P2

The saving efficiencies of the total moving time in DOC are the same when SRV moves firstly to one of any two defined positions due to SRV moves on the total constant distances, e.g. when the input speed of the driving unit $v_{d_{inp}} = 2 \text{ m/s}$, the input acceleration $a_{d_{inp}} = 2 \text{ m/s}^2$ (Table 5.1) and two chosen cases (P1=a1, P2=a6 and vice versa) then the saving time percentages in two cases of DOC (compared to the ones of SOC) are the same of 25% ($PT(a1a6) = PT(a6a1) = 25\%$).

The saving efficiencies of the total energy need change a little bit during all the ways of DOC when SRV moves firstly to one of any two defined positions. If only the two points are far from each other mainly by vertical direction and near the I/O point, the change is clearer, e.g. $v_{d_{inp}} = 2 \text{ m/s}$ and $a_{d_{inp}} = 2 \text{ m/s}^2$ (Table 5.1), the saving energy percentages $PE(a1a6) = PE(a6a1) = 25.9\%$; $PE(a5a16) = 11.5\%$ and $PE(a16a5) = 11.1\%$; $PE(a1a5) = 36.2\%$ and $PE(a5a1) = 34.2\%$.

The storage compartment is lower than the retrieval compartment and then the energy need is less than the one of vice versa. The reason is that the energy recuperation of the lifting unit is bigger when the retrieval compartment is higher (the unit load is lowered at higher altitude) and the energy consumption of the lifting unit is smaller when the storage compartment is lower (the unit load is lifted at lower altitude).

P1	P2	$v_{d\text{inp}} = 2 \text{ m/s}; a_{d\text{inp}} = 2 \text{ m/s}^2;$ $v_{l\text{inp}} = 4 \text{ m/s}; a_{l\text{inp}} = 4 \text{ m/s}^2$						$v_{d\text{inp}} = 4 \text{ m/s}; a_{d\text{inp}} = 3 \text{ m/s}^2;$ $v_{l\text{inp}} = 4 \text{ m/s}; a_{l\text{inp}} = 4 \text{ m/s}^2$					
		The energy need (kW)			The moving time (s)			The energy need (kW)			The moving time (s)		
		E_{TSC}	E_{DC}	$PE(\%)$	t_{TSC}	t_{DC}	$PT(\%)$	E_{TSC}	E_{DC}	$PE(\%)$	t_{TSC}	t_{DC}	$PT(\%)$
a1	a6	23.0	17.0	-25.9	15.3	11.5	-25.0	29.7	22.2	-25.2	12.2	9.2	-24.3
a6	a1	23.0	17.0	-25.9	15.3	11.5	-25.0	29.7	22.2	-25.2	12.2	9.2	-24.3
a4	a19	53.36	44.46	-16.7	25.4	21.6	-15.3	75.5	64.5	-14.6	17.7	14.4	-18.5
a19	a4	53.36	44.46	-16.7	25.4	21.6	-15.3	75.5	64.5	-14.6	17.7	14.4	-18.5
a1	a2	11.2	5.88	-47.5	10.4	7.03	-32.1	11.6	6.1	-47.6	9.6	6.6	-30.8
a2	a1	11.75	6.09	-48.2	10.4	7.03	-32.1	12.2	6.7	-45.3	9.6	6.6	-30.8
a1	a5	13.9	8.8	-36.2	11.1	8.6	-22.6	14.3	9.1	-36.6	10.7	8.4	-21.6
a5	a1	16.1	10.6	-34.2	11.1	8.6	-22.6	16.5	10.8	-34.6	10.7	8.4	-21.6
a6	a10	37.9	20.9	-45.0	20.3	13.2	-34.9	50.8	27.3	-46.3	14.8	10.5	-29.4
a10	a6	40.1	22.6	-43.7	20.3	13.2	-34.9	53.0	29.0	-45.2	14.8	10.5	-29.4
a22	a23	110.4	55.3	-49.9	50.3	27.0	-46.3	170.1	85.2	-49.9	29.8	16.8	-43.9
a23	a22	111.0	56.3	-49.3	50.3	27.0	-46.3	170.7	86.2	-49.5	29.8	16.8	-43.9
a5	a16	52.5	46.5	-11.5	26.1	21.9	-16.2	74.7	66.5	-10.9	18.4	14.8	-19.6
a16	a5	50.3	44.8	-11.1	26.1	21.9	-16.2	72.5	64.8	-10.6	18.4	14.8	-19.6
a7	a20	63.1	44.3	-29.8	30.3	21.5	-29.1	91.5	63.6	-30.6	19.8	14.3	-28.2
a20	a7	64.8	46.2	-28.7	30.3	21.5	-29.1	93.2	65.5	-29.8	19.8	14.3	-28.2
a1	a20	50.3	44.8	-11.1	25.3	21.5	-15.1	72.5	64.8	-10.6	17.2	14.2	-17.6
a20	a1	52.5	46.5	-11.5	25.3	21.5	-15.1	74.7	66.5	-10.9	17.2	14.2	-17.6

Table 5.1: Saving capacities of DOC when SRV moves firstly to one of any two defined positions.

5.2.2 When P1 and P2 are on the same height and P1 is fixed

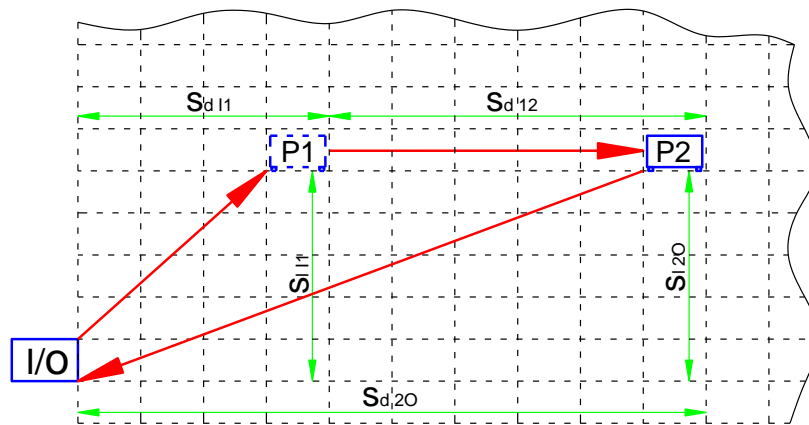

Figure 5.2: P1 and P2 are on the same height and P2 is farther than P1.

When P2 is farther from P1 and I/O point (Fig. 5.2), the saving capacities of the energy need and the moving time in DOC are lower and these values are much lower than their average values. The reason is that when the driving distance from P1 to P2 (s_{d12}) increases

and P1 is fixed, from Eq. (5.7), t_{11} is constant while t_{12} and t_{20} increase, t_{12} is closer to t_{20} . It means that the saving time percentage decreases clearly; from Eq. (5.8), the lifting unit energy need on every distance and E_{D11} are constant while E_{D12} and E_{D20} increase, E_{D12} is closer to E_{D20} . It means that the saving energy percentage decreases significantly, e.g. when $v_{dinp} = 2 \text{ m/s}$ and $a_{dinp} = 2 \text{ m/s}^2$ (Table 5.2), the saving energy percentages $PE(a1a6) = 25.9\%$, $PE(a1a11) = 16.9\%$ and $PE(a1a21) = 10.2\%$; The saving time percentages $PT(a1a6) = 25\%$, $PT(a1a11) = 18.8\%$ and $PT(a1a21) = 12.6\%$ while the average efficient percentages at these kinematic parameters (Table 4.3) of the average energy need ($\overline{\Delta E_{DC-SC}} = 32.3\%$) and the average moving time ($\overline{\Delta t_{DC-SCmo}} = 31.9\%$) are much larger.

When $v_{dinp} = 4 \text{ m/s}$ and $a_{dinp} = 3 \text{ m/s}^2$ (Table 5.2), the rule of reducing the saving capacities of the energy need and the moving time is similar to $v_{dinp} = 2 \text{ m/s}$ and $a_{dinp} = 2 \text{ m/s}^2$.

P1	P2	$v_{dinp} = 2 \text{ m/s}; a_{dinp} = 2 \text{ m/s}^2;$ $v_{linp} = 4 \text{ m/s}; a_{linp} = 4 \text{ m/s}^2$						$v_{dinp} = 4 \text{ m/s}; a_{dinp} = 3 \text{ m/s}^2;$ $v_{linp} = 4 \text{ m/s}; a_{linp} = 4 \text{ m/s}^2$					
		The energy need (kW)			The moving time (s)			The energy need (kW)			The moving time (s)		
		E_{rsc}	E_{DC}	$PE(\%)$	t_{rsc}	t_{DC}	$PT(\%)$	E_{rsc}	E_{DC}	$PE(\%)$	t_{rsc}	t_{DC}	$PT(\%)$
a1	a6	23.0	17.0	-25.9	15.3	11.5	-25.0	29.7	22.2	-25.2	12.2	9.2	-24.3
a1	a11	35.2	29.3	-16.9	20.3	16.5	-18.8	49.8	41.6	-16.5	14.7	11.7	-20.5
a1	a21	59.7	53.6	-10.2	30.3	26.5	-12.6	89.7	81.5	-9.2	19.7	16.7	-15.3
a3	a8	26.7	18.9	-29.1	15.3	11.5	-25.0	33.4	24.1	-27.8	12.2	9.2	-24.3
a3	a13	38.9	31.2	-20.0	20.3	16.5	-18.8	53.5	43.5	-18.7	14.7	11.7	-20.5
a3	a23	63.4	55.5	-12.5	30.3	26.5	-12.6	93.5	83.4	-10.8	19.7	16.7	-15.3
a21	a16	96.1	53.6	-44.2	45.3	26.5	-41.5	147.9	81.3	-45.0	27.3	16.8	-38.6
a21	a11	83.9	53.6	-36.1	40.3	26.5	-34.3	128.1	80.8	-37.0	24.8	16.8	-32.6
a21	a6	71.7	53.5	-25.3	35.3	26.5	-25.0	108.0	80.7	-25.3	22.3	16.8	-25.0
a21	a1	59.7	53.6	-10.2	30.3	26.5	-12.6	89.7	81.5	-9.2	19.7	16.7	-15.3
a5	a10	31.0	21.2	-31.6	16.1	11.9	-26.2	37.7	26.3	-30.0	13.4	9.8	-26.6
a5	a15	43.2	33.4	-22.7	21.1	16.9	-20.0	57.8	45.7	-20.8	15.9	12.3	-22.7
a5	a25	67.6	57.7	-14.7	31.1	26.9	-13.6	97.7	85.6	-12.4	20.9	17.3	-17.3
a6	a11	47.2	29.2	-38.3	25.3	16.5	-34.8	68.1	41.4	-39.2	17.3	11.8	-31.9
a16	a21	96.1	53.6	-44.2	45.3	26.5	-41.5	147.9	81.3	-45.0	27.3	16.8	-38.6
a8	a13	51.0	31.1	-39.0	25.3	16.5	-34.8	71.8	43.3	-39.7	17.3	11.8	-31.9
a18	a23	99.8	55.5	-44.4	45.3	26.5	-41.5	151.7	83.2	-45.1	27.3	16.8	-38.6
a10	a15	55.2	33.3	-39.7	25.3	16.5	-34.8	76.0	45.5	-40.1	17.3	11.8	-31.9
a20	a25	104.	57.7	-44.5	45.3	26.5	-41.5	155.9	85.5	-45.2	27.3	16.8	-38.6

Table 5.2: Saving capacities of moving time and energy need by horizontal direction of DOC.

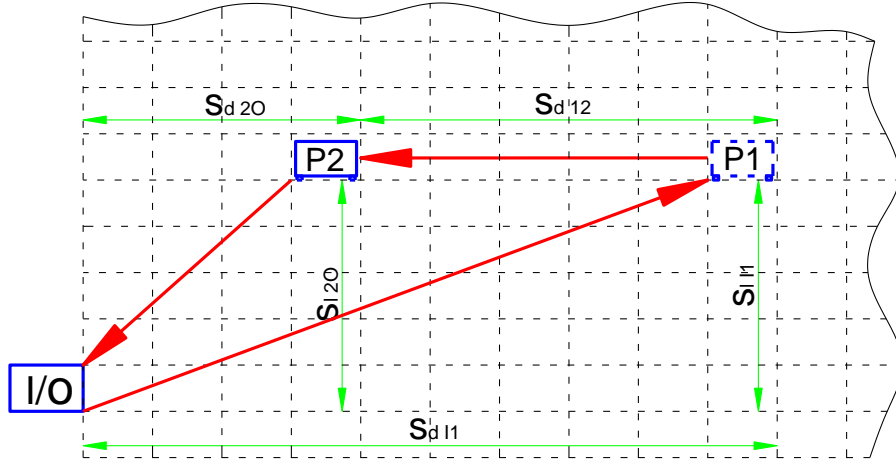

Figure 5.3: P1 and P2 are on the same height and P1 is farther than P2.

When P1 is farther than P2 (Fig. 5.3) and P2 is closer to I/O point, the saving capacities of the energy need and the moving time in DOC are lower and reduce faster than these values when P2 is farther from P1 (Fig. 5.2). These saving capacities are much higher than the average values when P2 is close to P1 and they reduce very quickly when P2 is far from P1. The reason is that when s_{d12} increases and P1 is fixed, from Eq. (5.7), t_{11} is constant and t_{20} decreases while t_{12} increases. It means that the saving time percentage decreases significantly; from Eq. (5.8), the lifting unit energy need on every distance and E_{D11} are constant and E_{D20} decreases while E_{D12} increases. Therefore, the saving energy percentage decreases significantly, e.g. $v_{dimp} = 2\text{ m/s}$ and $a_{dimp} = 2\text{ m/s}^2$ (Table 5.2), the saving energy percentages $PE(a21a16) = 44.2\%$, $PE(a21a6) = 25.3\%$ and $PE(a21a1) = 10.2\%$; The saving time percentages $PT(a21a16) = 41.5\%$, $PT(a21a6) = 25\%$ and $PT(a21a1) = 12.6\%$.

In general, P1 is fixed and P2 changes horizontally, the saving efficiencies of the energy need and the moving time of DOC change clearly.

5.2.3 When P1 and P2 are on the same height and s_{d12} is constant (Fig. 5.2 and Fig. 5.3)

When the position of s_{d12} is farther from I/O point horizontally, the saving efficiencies of the energy need and the moving time are higher and these values are higher than their average values. The reason is that from Fig. 5.2 and Fig. 5.3, s_{d12} is constant and the positions P1 and P2 are farther from I/O point, from Eq. (5.7), t_{12} is constant while t_{11} and t_{20} increase. It means that the saving time percentage increases; from Eq. (5.8), the lifting unit energy need on every distance and E_{D12} are constant while E_{D11} and E_{D20} increase. Therefore, the saving energy percentage increases, e.g. when $v_{dimp} = 2\text{ m/s}$ and

$a_{dinp} = 2 \text{ m/s}^2$ (Table 5.2), the saving energy percentages $PE(a1a6) = 25.9\%$, $PE(a6a11) = 38.3\%$ and $PE(a16a21) = 44.2\%$; the saving time percentages $PT(a1a6) = 25\%$, $PT(a6a11) = 34.8\%$ and $PT(a16a21) = 41.5\%$, etc.

The higher the constant distance s_{d12} is, the better the saving energy efficiency is. However, the saving capacity does not change much when two positions are far from I/O point horizontally, e.g. $v_{dinp} = 2 \text{ m/s}$ and $a_{dinp} = 2 \text{ m/s}^2$ (Table 5.2), the saving energy percentages $PE(a6a11) = 38.3\%$, $PE(a8a13) = 39\%$ and $PE(a10a15) = 39.7\%$, etc.

The reason is that s_{d12} is constant and the positions of P1P2 are higher from I/O point, from Eq. (5.8), $E_{L12} = 0$ and two positions are far from I/O point horizontally so the driving unit energy need on every distance is constant and quite big. On the other hand, the lifting heights ($s_{L11} = s_{L12}$) are equal to the lowering heights ($s_{L20} = s_{L10}$) and the energy recovery rate of the lifting unit based on the experimental results is quite high about 70% of the energy consumption on every lifting height (Section 3.4.2) and then $E_{L10} + E_{L11} + E_{L12} + E_{L20}$ increases a little bit and is usually quite smaller than the driving unit values. It means the saving energy percentage only increases by the lifting height and these values do not change much.

When both positions are near I/O point, the driving unit energy need is small and the saving capacity changes more about 5% to 6%, e.g. when $v_{dinp} = 2 \text{ m/s}$ and $a_{dinp} = 2 \text{ m/s}^2$ then $PE(a1a6) = 25.9\%$, $PE(a3a8) = 29.1\%$ and $PE(a5a10) = 31.6\%$, etc.

In this case, the moving time efficiency may be equal or bigger. When the driving time is more than the lifting time on each distance, t_{12} , t_{11} and t_{20} are constant, from Eq. (5.7), the moving time efficiency is equal, e.g. when $v_{dinp} = 2 \text{ m/s}$ and $a_{dinp} = 2 \text{ m/s}^2$ (Table 5.2) then $PT(a6a11) = 34.8\%$, $PT(a8a13) = 34.8\%$ and $PT(a10a15) = 34.8\%$, etc. Besides, when both positions are near I/O point horizontally, the driving time is smaller than the lifting time, t_{11} and t_{20} increase, from Eq. (5.7), the moving time efficiency is higher. However, saving capacity does not change much due to the kinematic parameters of the lifting unit are big, e.g. when $v_{dinp} = 2 \text{ m/s}$ and $a_{dinp} = 2 \text{ m/s}^2$ then $PT(a1a6) = 25\%$, $PT(a5a10) = 26.2\%$; when $v_{dinp} = 4 \text{ m/s}$ and $a_{dinp} = 3 \text{ m/s}^2$ then $PT(a1a6) = 24.3\%$, $PT(a5a10) = 26.6\%$, etc.

5.2.4 When P1 and P2 are on the same length and P1 is fixed

When P2 is higher from P1 (Fig. 5.4), the saving efficiencies of the energy need and the moving time in DOC are lower. These efficiencies are much higher than their average

values (Table 4.3) and reduce a little bit when two positions are far from I/O horizontally, e.g. $v_{dimp} = 2 \text{ m/s}$ and $a_{dimp} = 2 \text{ m/s}^2$ (Table 5.3), the saving energy percentages $PE(a21a22) = 49.7\%$, $PE(a21a25) = 48.3\%$; The saving time percentages $PT(a21a22) = 46.3\%$ and $PT(a21a25) = 43.9\%$, etc.

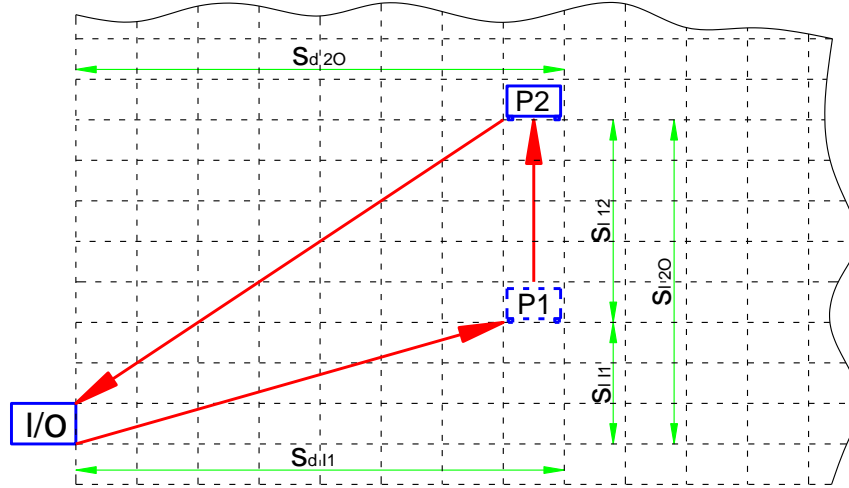

Figure 5.4: P1 and P2 are on the same length and P2 is higher than P1.

Due to P2 is higher and higher from P1 and P1 is fixed, the lifting distance s_{l12} increases. When two positions are horizontally far from I/O point, the driving time is bigger than the lifting time on the distances IP1 and P2O and then t_{l1} and t_{l20} is constant and big. While the kinematic parameters of the lifting unit are big and the maximum lifting height is only about 6.5 m then t_{l2} increases but it is quite smaller than t_{l1} and t_{l20} . From the above reasons and Eq. (5.7), the saving efficiency of the moving time in DOC is lower but only changes a little bit when P2 is higher and higher from P1;

From Eq. (5.9), E_{Dl1} and E_{Dl20} are constant, $E_{Dl2} = 0$, E_{Ll1} and E_{Ll0} are constant whereas E_{Ll2} and E_{Ll2} increase and E_{Ll2} is closer to E_{Ll2} . Furthermore, the lifting unit energy recovery is about 70% of the energy consumption on every lifting height so $(E_{Ll2} + E_{Ll20})$ is closer to $(E_{Ll2} + E_{Ll20})$ and they are quite smaller than $(E_{Dl1} + E_{Dl20})$. Therefore, the saving efficiency of the energy need in DOC is lower but only changes a little bit when P2 is higher and higher from P1.

These efficiencies decrease much more when two positions are near I/O point horizontally. From Eq. (5.7), when the driving time is smaller than the lifting time and then t_{l20} increases; t_{l1} is fixed and small; t_{l2} and t_{l20} increase and t_{l2} is closer to t_{l20} and then the saving efficiency of the moving time in DOC decreases more clearly, e.g. $v_{dimp} = 2 \text{ m/s}$ and $a_{dimp} = 2 \text{ m/s}^2$ (Table 5.3) then $PT(a1a2) = 32.1\%$ and $PT(a1a5) = 22.6\%$.

From Eq. (5.9), E_{D11} and E_{D20} are constant and small, $E_{D12} = 0$, E_{L11} and E_{L10} are constant while E_{L12} and E_{L20} increase, $(E_{L12} + E_{L20})$ is closer to $(E_{L12} + E_{L20})$. It means that the saving efficiency of the energy need in DOC decreases more clearly, e.g. $v_{dimp} = 2 \text{ m/s}$ and $a_{dimp} = 2 \text{ m/s}^2$ (Table 5.3) then $PE(a1a2) = 47.5\%$, $PE(a1a5) = 36.2\%$.

When P1 is higher from P2, the saving efficiencies of the energy need and the moving time in DOC are lower. These values are also much higher than their average values and the reason is explained similarly when P2 is higher than P1.

In general, P1 is fixed and P2 changes vertically, the saving efficiencies of the energy need and the moving time of DOC change a little bit and these values are quite high.

P1	P2	$v_{dimp} = 2 \text{ m/s}; a_{dimp} = 2 \text{ m/s}^2;$ $v_{limp} = 4 \text{ m/s}; a_{limp} = 4 \text{ m/s}^2$						$v_{dimp} = 4 \text{ m/s}; a_{dimp} = 3 \text{ m/s}^2;$ $v_{limp} = 4 \text{ m/s}; a_{limp} = 4 \text{ m/s}^2$					
		The energy need (kWs)			The moving time (s)			The energy need (kWs)			The moving time (s)		
		E_{TSC}	E_{DC}	$PE(\%)$	t_{TSC}	t_{DC}	$PT(\%)$	E_{TSC}	E_{DC}	$PE(\%)$	t_{TSC}	t_{DC}	$PT(\%)$
a1	a2	11.2	5.9	-47.5	10.4	7.0	-32.1	11.6	6.1	-47.6	9.6	6.6	-30.8
a1	a3	12.3	6.9	-43.6	10.4	7.5	-27.4	12.7	7.1	-43.8	9.6	7.1	-25.5
a1	a5	13.9	8.8	-36.2	11.1	8.6	-22.6	14.3	9.1	-36.6	10.7	8.4	-21.6
a11	a12	59.7	30.1	-49.5	30.3	17.0	-43.9	88.4	44.5	-49.7	19.8	11.8	-40.8
a11	a13	60.8	31.2	-48.7	30.3	17.5	-42.3	89.5	45.5	-49.1	19.8	12.3	-38.3
a11	a15	62.3	33.1	-46.9	30.3	18.2	-39.9	91.1	47.4	-47.9	19.8	13.0	-34.6
a15	a14	66.7	34.0	-49.0	30.3	17.0	-43.9	95.4	48.3	-49.3	19.8	11.8	-40.8
a15	a13	65.8	34.2	-48.1	30.3	17.5	-42.3	94.6	48.6	-48.7	19.8	12.3	-38.3
a15	a12	64.8	34.6	-46.7	30.3	17.9	-41.0	93.5	48.9	-47.7	19.8	12.6	-36.3
a15	a11	64.5	34.8	-46.1	30.3	18.2	-39.9	93.3	49.2	-47.3	19.8	13.0	-34.6
a21	a22	108.	54.6	-49.7	50.3	27.0	-46.3	168.3	84.4	-49.8	29.8	16.8	-43.9
a21	a23	109.	55.6	-49.3	50.3	27.5	-45.3	169.4	85.5	-49.5	29.8	17.3	-42.2
a21	a25	111.	57.5	-48.3	50.3	28.2	-43.9	170.9	87.4	-48.9	29.8	18.0	-39.8
a3	a4	15.5	8.0	-48.3	10.5	7.1	-32.4	16.0	8.2	-48.4	10.1	6.9	-31.7
a4	a5	17.7	9.2	-47.7	11.2	7.5	-33.6	18.1	9.5	-47.8	11.2	7.5	-33.6
a13	a14	64.0	32.3	-49.6	30.3	17.0	-43.9	92.7	46.6	-49.7	19.8	11.8	-40.8
a14	a15	66.1	33.5	-49.4	30.3	17.0	-43.9	94.9	47.8	-49.6	19.8	11.8	-40.8
a23	a24	112.	56.7	-49.8	50.3	27.0	-46.3	172.6	86.6	-49.8	29.8	16.8	-43.9
a24	a25	115.	57.9	-49.6	50.3	27.0	-46.3	174.7	87.8	-49.8	29.8	16.8	-43.9
a6	a8	36.3	18.9	-47.8	20.3	12.5	-38.5	49.2	25.4	-48.4	14.8	9.8	-34.3
a8	a10	40.3	21.2	-47.4	20.3	12.5	-38.5	53.2	27.7	-48.1	14.8	9.8	-34.3

Table 5.3: Saving capacities of the moving time and energy need by vertical direction of DOC.

5.2.5 When P1 and P2 are on the same length and s_{l12} is constant (Fig. 5.4)

The saving efficiencies of the energy need and the moving time are significantly unchangeable when the position of P1P2 changes vertically. In this case, t_{12} is constant and when the driving time is bigger than the lifting time in the distances of IP1 and P2O, t_{11} and t_{20} are constant. Therefore, from Eq. (5.7), the saving efficiency of moving time is equal, e.g. $v_{dimp} = 2\text{m/s}$ and $a_{dimp} = 2\text{m/s}^2$ (Table 5.3) then the saving time percentage $PT(a11a12) = 43.9\%$; $PT(a13a14) = 43.9\%$ and $PT(a14a15) = 43.9\%$, etc. when the driving time is smaller than the lifting time in the distances of IP1 and P2O (P1 and P2 are at high positions and near I/O point horizontally), t_{11} and t_{20} increase. Therefore, from Eq. (5.7), the saving efficiency of the moving time is higher. This saving efficiency does not change much due to the kinematic parameters of the lifting unit are big and the maximum lifting height is not high, e.g. $v_{dimp} = 2\text{m/s}$ and $a_{dimp} = 2\text{m/s}^2$ (Table 5.3) then $PT(a1a2) = 32.1\%$ and $PT(a4a5) = 33.6\%$, etc.

Besides, the driving unit energy need on every distance and E_{L12} are constant, the lifting unit energy recovery is about 70% of the energy consumption on every lifting height and then the remaining lifting unit energy need in Equation (5.9) affects a little bit to the total value and the saving efficiency of the energy need is significantly unchangeable, e.g. $v_{dimp} = 2\text{m/s}$ and $a_{dimp} = 2\text{m/s}^2$ (Table 5.3) then $PE(a11a12) = 49.5\%$, $PE(a13a14) = 49.6\%$ and $PE(a14a15) = 49.4\%$, etc.

The farther the constant distance s_{l12} at the same height is, the higher the saving efficiencies of the energy need and the moving time are. These efficiencies are much higher than their average values, e.g. $v_{dimp} = 2\text{m/s}$ and $a_{dimp} = 2\text{m/s}^2$ (Table 5.3) then $PE(a1a2) = 47.5\%$, $PE(a11a12) = 49.5\%$ and $PE(a21a22) = 49.7\%$; $PT(a1a2) = 32.1\%$, $PT(a11a12) = 43.9\%$ and $PT(a21a22) = 46.3\%$, etc. The reason is that the lifting heights are constant in every driving distance. Therefore, from Eq. (5.7), t_{12} is constant while t_{11} and t_{20} increase. It means that the saving efficiency of the moving time in DOC increases. From Eq. (5.8), $E_{D12} = 0$, E_{D11} and E_{D20} increase while the lifting unit energy need is constant in every moving distance. Therefore, the saving efficiency of the energy need in DOC increases.

5.2.6 When P1&P2 are located on a tilt line with the constant distance of P1P2 (Fig. 5.5)

When the position of P1P2 is farther from I/O point, the saving efficiencies of the energy need and the moving time are higher, e.g. $v_{dimp} = 2\text{m/s}$ and $a_{dimp} = 2\text{m/s}^2$ (Table 5.4) then

$PE(a1a7) = 25\%$, $PE(a7a13) = 38.6\%$ and $PE(a19a25) = 44.2\%$; $PT(a1a7) = 25\%$, $PT(a7a13) = 34.8\%$ and $PT(a19a25) = 41.5\%$, etc.

The result is explained by a combination of Section 5.2.3 and Section 5.2.5 of changing the constant distances in both directions (Fig. 5.5).

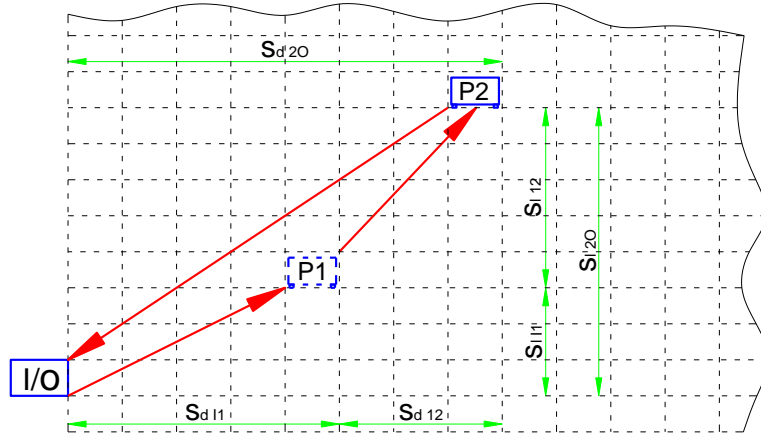

Figure 5.5: P1 and P2 are on any position.

P1	P2	$v_{d\text{inp}} = 2 \text{ m/s}; a_{d\text{inp}} = 2 \text{ m/s}^2;$ $v_{l\text{inp}} = 4 \text{ m/s}; a_{l\text{inp}} = 4 \text{ m/s}^2$						$v_{d\text{inp}} = 4 \text{ m/s}; a_{d\text{inp}} = 3 \text{ m/s}^2;$ $v_{l\text{inp}} = 4 \text{ m/s}; a_{l\text{inp}} = 4 \text{ m/s}^2$					
		The energy need (kW)			The moving time (s)			The energy need (kW)			The moving time (s)		
		E_{TSC}	E_{DC}	$PE(\%)$	t_{TSC}	t_{DC}	$PT(\%)$	E_{TSC}	E_{DC}	$PE(\%)$	t_{TSC}	t_{DC}	$PT(\%)$
a1	a7	23.2	17.4	-25.0	15.3	11.5	-25.0	29.9	22.6	-24.5	12.2	9.2	-24.3
a7	a13	49.3	30.3	-38.6	25.3	16.5	-34.8	70.1	42.5	-39.4	17.3	11.8	-31.9
a19	a25	102.	57.4	-44.2	45.3	26.5	-41.5	154.6	85.1	-45.0	27.3	16.8	-38.6
a5	a9	30.2	21.3	-29.5	16.1	11.9	-26.2	36.9	26.5	-28.3	13.4	9.8	-26.6
a9	a13	52.3	32.4	-38.1	25.3	16.5	-34.8	73.2	44.6	-39.0	17.3	11.8	-31.9
a17	a21	96.9	54.6	-43.7	45.3	26.5	-41.5	148.7	82.3	-44.7	27.3	16.8	-38.6
a13	a5	40.5	32.9	-18.7	21.1	16.9	-20.0	55.1	45.3	-17.8	15.9	12.3	-22.7
a13	a10	52.5	32.8	-37.5	25.3	16.5	-34.8	73.4	45.1	-38.6	17.3	11.8	-31.9
a13	a15	64.8	33.4	-48.4	30.3	17.5	-42.3	93.5	47.8	-48.9	19.8	12.3	-38.3
a13	a20	77.0	45.1	-41.5	35.3	21.5	-39.1	113.3	65.1	-42.6	22.3	14.3	-36.0
a13	a25	89.2	57.3	-35.8	40.3	26.5	-34.3	133.4	84.4	-36.7	24.8	16.8	-32.6
a13	a1	37.6	31.8	-15.4	20.3	16.5	-18.8	52.2	44.2	-15.4	14.7	11.7	-20.5
a13	a6	49.7	31.7	-36.1	25.3	16.5	-34.8	70.5	44.0	-37.6	17.3	11.8	-31.9
a13	a11	61.9	32.3	-47.8	30.3	17.5	-42.3	90.6	46.7	-48.5	19.8	12.3	-38.3
a13	a16	74.1	44.0	-40.7	35.3	21.5	-39.1	110.4	63.9	-42.1	22.3	14.3	-36.0
a13	a2	37.9	31.4	-17.1	20.3	16.5	-18.8	52.4	43.7	-16.6	14.7	11.7	-20.5
a13	a3	38.9	31.2	-20.0	20.3	16.5	-18.8	53.5	43.5	-18.7	14.7	11.7	-20.5
a13	a4	39.8	31.8	-20.1	20.4	16.6	-19.0	54.3	44.1	-18.8	15.2	11.9	-21.5
a13	a18	75.4	43.3	-42.6	35.3	21.5	-39.1	111.7	63.3	-43.4	22.3	14.3	-36.0
a13	a17	74.3	43.6	-41.4	35.3	21.5	-39.1	110.6	63.5	-42.6	22.3	14.3	-36.0
a13	a19	76.2	43.9	-42.4	35.3	21.5	-39.1	112.5	63.9	-43.2	22.3	14.3	-36.0

Table 5.4: Saving capacities of moving time and energy need in the general cases of DOC.

5.2.7 When P1 is fixed and P2 changes (Fig. 5.5).

When P2 changes on the same heights and then P2 is farther from P1 horizontally, the saving efficiencies of the energy need and the moving time are lower, and these values decrease quite a lot, e.g. $v_{dimp} = 2\text{ m/s}$ and $a_{dimp} = 2\text{ m/s}^2$ (Table 5.4) then $PE(a13a15) = 48.4\%$, $PE(a13a10) = 37.5\%$ and $PE(a13a5) = 18.7\%$; $PT(a13a15) = 42.3\%$, $PT(a13a10) = 34.8\%$ and $PT(a13a5) = 20\%$, etc. The reason is that the lifting heights are constant in every distance and the driving distances change as Section 5.2.2 then it is explained as the above Section.

The remaining positions P2 are symmetric following vertical direction of P1. After that, P2 is farther from the I/O point, the saving efficiencies of the energy need and the moving time of DOC are better, e.g. $v_{dimp} = 2\text{ m/s}$ and $a_{dimp} = 2\text{ m/s}^2$ (Table 5.4) then $PE(a13a5) = 18.7\%$, $PE(a13a25) = 35.8\%$; $PT(a13a5) = 20\%$, $PT(a13a25) = 34.3\%$, etc. The reason is that the lifting heights are constant in every distance and the driving distances are explained as the same as Section 5.2.3.

When P2 changes on the same lengths and then P2 is farther from P1 vertically, the saving efficiency of the energy need is lower. However, the saving capacity does not change much, e.g. $v_{dimp} = 2\text{ m/s}$ and $a_{dimp} = 2\text{ m/s}^2$ (Table 5.4) then $PE(a13a18) = 42.6\%$, $PE(a13a19) = 42.4\%$ and $PE(a13a20) = 41.5\%$, etc. Besides, the saving efficiency of the moving time is usually equal or changes a little bit, e.g. $PT(a13a18) = 39.1\%$ and $PT(a13a20) = 39.1\%$, etc. The reason is that the driving distances are constant, when P2 changes vertically. When the driving time is bigger than the lifting time in P1P2 and then the saving efficiency of the moving time is equal. When the driving time is smaller than the lifting time in P1P2 then t_{12} increases and it is explained as the same as Section 5.2.4.

The remaining positions P2 are symmetric following horizontal direction of P1. After that, P2 is upper the horizontal direction of P1, the saving efficiency of the energy need is better and the saving efficiency of moving time is equal or higher. Their saving capacities do not change much, e.g. $v_{dimp} = 2\text{ m/s}$ and $a_{dimp} = 2\text{ m/s}^2$ (Table 5.4) then $PE(a13a17) = 41.4\%$ and $PE(a13a19) = 42.4\%$; $PT(a13a17) = 39.1\%$ and $PT(a13a19) = 39.1\%$, etc. The reason is that the driving distances are constant and the lifting heights change as Section 5.2.5 and then it is explained as the same as above Section.

When P2 changes on a tilt line and P2 is farther from P1, the saving efficiencies of the energy need and the moving time are lower. It is explained by a combination of Section 5.2.2 and 5.2.4.

5.3 Summary

The simulation model of DOC is created. After that, the energy need and the moving time of SRV in DOC at every position are compared to the ones in SOC. From Section 5.2, there are some results when a storage position and a retrieval position are chosen in a pair to achieve the high saving efficiencies of the energy need and the moving time of DOC compared to the ones of SOC as below:

The farther from the I/O point a storage position and a retrieval position are and the nearer to each other by horizontal direction they are, the higher the saving efficiencies of the energy need and the moving time in DOC are. These values are much higher than their average values.

When SRV moves firstly to one of any two defined positions P1 and P2, the saving efficiencies of the total moving time in DOC are the same and the saving efficiencies of the total energy need change a little bit during all the ways of DOC.

When the storage and retrieval positions are far from each other mainly by vertical direction, the saving efficiency of the energy need in DOC changes a little bit and the saving efficiency of moving time is equal or also changes a little bit (the smaller the driving unit speed is, the less the change of the saving efficiency is). Therefore, when the logical choice between a storage compartment and a retrieval compartment is performed, the vertical of the storage and retrieval positions can be ignored. However, this result is only applied when SRV has an energy recovery system (the energy recovery of the lifting unit is about 70% of the energy consumption on every lifting height) and the system's height is average.

The general method of logical choice among the storage and retrieval positions of DOC could be developed by directly comparing the pairs of DOC in order to analyze the flexible pairs of DOC and their impact to SRV-strategies to save the best efficiency of the energy need and the moving time.

Chapter 6

Logical choice method among the positions in the double operation cycle and its effective evaluation

After the efficiency of choosing between a storage position and a retrieval position in DOC is determined in Chapter 5, the logical choice method among many storage and retrieval positions of DOC should be considered to reduce the energy need and increase the throughput of SRV. The method of choosing the pairs of DOC is derived from simple choices with small numbers of the compartments. After that, it is extended to the entire system to achieve the best efficiencies of the energy need and the moving time.

When the logical choice method among the positions of DOC is determined, its efficiency is considered in detail in each case.

6.1 Logical choice method among the positions of the double operation cycle

To determine the logical choice method among the positions of DOC, the inductive approach is used. This is a form of direct proof, usually done in two steps. When trying to prove that a choice is true for a set of storage and retrieval positions, the first step, called the base step, is to prove the proposition is true for the simple choice. The second step, called the inductive step, is to prove that, if the proposition is assumed to be true for any given number, then it is also true for the next case. After proving these two steps, the inference rule asserts that the proposition is true for all cases. In general, using the above method is called the principle of mathematical induction.

The method of the most efficient choice between a storage position and a retrieval position is indicated in Chapter 5. In the next step, it is assumed that there are four positions selected for any two pairs of DOC. P1 and P3 are two storage positions; P2 and P4 are two retrieval positions accordingly.

When these positions are changed, the best way to choose the suitable pairs of DOC can be found by analyzing some cases.

The energy need and the working time of the load handling device in every DOC are the same and then in order to simplify, they are not included in the next analysis.

Four positions can be selected in two ways as below:

The first way is two pairs P1P2 and P3P4 and the second way is two pairs P1P4 and P2P3.

The total moving time of the driving unit and the lifting unit in the first way t_{TDC1} is calculated by Equation (6.1) and in the second way t_{TDC2} by Equation (6.2); the difference moving time between two options is shown by Equation (6.3). The energy need of the driving unit and the lifting unit in the first way E_{TDC1} is presented by Equation (6.4) and in the second way E_{TDC2} by Equation (6.5); the difference energy need between two options is shown by Equation (6.6).

$$t_{TDC1} = t_{I1} + t_{I3} + t_{2O} + t_{4O} + t_{12} + t_{34} \quad (6.1)$$

$$t_{TDC2} = t_{I1} + t_{I3} + t_{2O} + t_{4O} + t_{14} + t_{32} \quad (6.2)$$

$$t_{TDC2} - t_{TDC1} = t_{14} + t_{32} - (t_{12} + t_{34}) \quad (6.3)$$

$$E_{TDC1} = E_{D11} + E_{D13} + E_{D2O} + E_{D4O} + E_{L11} + E_{L13} + E_{L2O} + E_{L4O} + E_{D12} + E_{D34} + E_{L12} + E_{L34} \quad (6.4)$$

$$E_{TDC2} = E_{D11} + E_{D13} + E_{D2O} + E_{D4O} + E_{L11} + E_{L13} + E_{L2O} + E_{L4O} + E_{D14} + E_{D32} + E_{L14} + E_{L32} \quad (6.5)$$

$$E_{TDC2} - E_{TDC1} = E_{D14} + E_{D32} - E_{D12} - E_{D34} + E_{L14} + E_{L32} - E_{L12} - E_{L34} \quad (6.6)$$

6.1.1 Some remarks before choosing the logical positions

Based on Equation (6.6), the different energy need of the lifting unit E_{Ldif} is considered first by Equation (6.7). In this case, only the height of the positions is considered. Due to P1 and P3 are the storage positions, P2 and P4 are the retrieval positions, it is assumed that the storage position P1 is lower than P3 and the retrieval position P2 is lower than P4.

$$E_{Ldif} = E_{L14} + E_{L32} - E_{L12} - E_{L34} \quad (6.7)$$

To determine the different energy need of the lifting unit E_{Ldif} in any way, some cases are compared when the heights of the storage and retrieval positions are changed. The different energy need of the lifting unit is determined by Fig. 6.1a and Eq. (6.8) when P2 and P4 are between P1 and P3; by Fig. 6.1b and Eq. (6.9) when P4 is at the top and P2 is between P1

and P3; by Fig. 6.1c and Eq. (6.10) when P1 and P3 are under P2 and P4; by Fig. 6.1d and Eq. (6.11) when P1 and P3 are between P2 and P4; by Fig. 6.1e and Eq. (6.12) when P3 is at the top and P1 is between P2 and P4; by Fig. 6.1f and Eq. (6.13) when P1 and P3 are above P2 and P4.

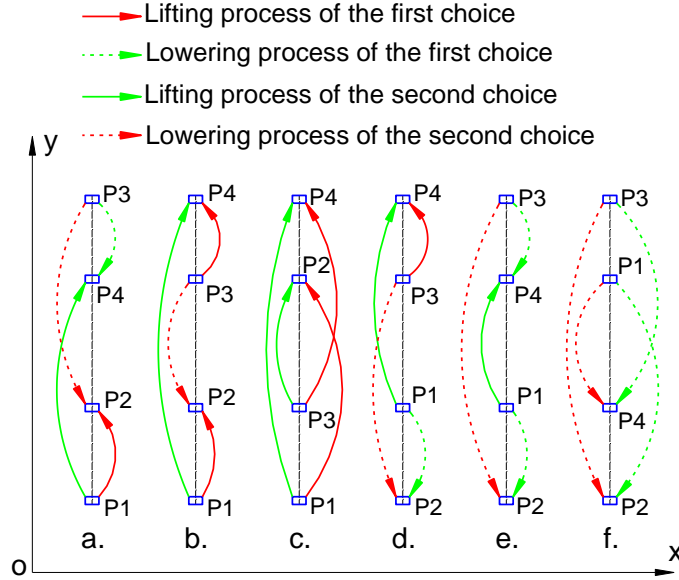

Figure 6.1: Cases of storage and retrieval positions vertically.

$$E_{Ldif a} = |E_{L14}| - |E_{L32}| - |E_{L12}| + |E_{L34}| \quad (6.8)$$

$$E_{Ldif b} = |E_{L14}| - |E_{L32}| - |E_{L12}| - |E_{L34}| \quad (6.9)$$

$$E_{Ldif c} = |E_{L14}| + |E_{L32}| - |E_{L12}| - |E_{L34}| \quad (6.10)$$

$$E_{Ldif d} = |E_{L14}| - |E_{L32}| + |E_{L12}| - |E_{L34}| \quad (6.11)$$

$$E_{Ldif e} = |E_{L14}| - |E_{L32}| + |E_{L12}| + |E_{L34}| \quad (6.12)$$

$$E_{Ldif f} = -|E_{L14}| - |E_{L32}| + |E_{L12}| + |E_{L34}| \quad (6.13)$$

Total positive and negative values in all cases from Equation (6.8) to Equation (6.13) are always performed on total equal altitudes (see the highlight in green and red colors in Fig. 6.1). Besides, the height of the system is average about 6.5 m and the energy recovery rate of the lifting unit is about 70% its energy consumption on every height and every kinematic parameter [79] and then E_{Ldif} is small and affects a little bit to total energy need in Equation (6.6). Therefore, the next analyses in Equation (6.6) only focus on the driving unit energy need when the selected ways are compared.

The speed and the acceleration of the lifting unit are quite big ($v_{l_{inp}} = v_{l_{max}} = 4 \text{ m/s}$ and $a_{l_{inp}} = a_{l_{max}} = 4 \text{ m/s}^2$) and the maximum lifting height is average. Therefore, in most cases, the height difference among the positions is not much and when SRV moves from the

storage position to the retrieval position, the lifting time is less than the moving time of the driving unit. Only a few cases, the difference in height among the positions is quite big compared to the difference in the driving distance among positions, then the lifting time is a little bit bigger than the driving time and it does not significantly affect to the total working time of SRV. Therefore, the next analyses of Equation (6.3) only focus on the moving time of the driving unit when the selected ways are compared.

As a result, the height of the positions can be ignored when the energy need and the moving time one by one in the cases of DOC are compared to each other.

6.1.2 Some cases to determine the logical choice method among the positions

The height of the positions is ignored when the positions are chosen to achieve the high efficiency of the energy need and the moving time. Therefore, only the horizontal of the positions is considered.

It is assumed that the storage position P1 is always nearer than P3 and the retrieval position P2 is always nearer than P4 horizontally. Some cases are indicated to determine logical choice among the positions when four positions are changed, see Fig 6.2 and some examples on Table 6.1.

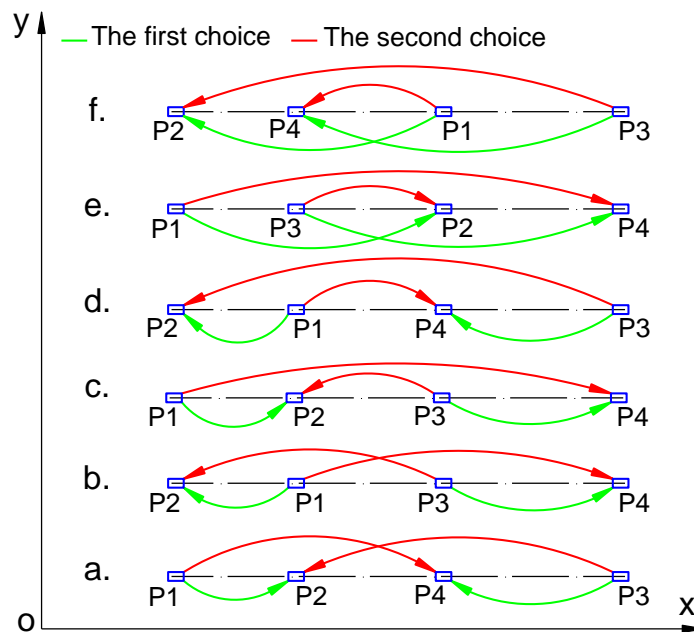

Figure 6.2: Cases of the storage and retrieval positions horizontally.

From Fig. 6.2, some cases are considered as below to determine logical choice among the positions from which, the efficiencies of the energy need and the moving time in DOC increase clearly.

Case a: when P2 and P4 are in between P1 and P3 horizontally (Fig. 6.2a)

The farthest storage position P3 is chosen in a pair with the farthest retrieval position P4 and P1 is chosen in a pair with P2. After that, the saving efficiencies of the energy need

and the moving time are better than the second way, e.g. Table 6.1 Case a: the moving time by the second choice (a6a17 & a24a13) is higher 8.39% than the one by the first choice (a6a13 & a24a17) ($PMT(a) = 8.39\%$) and the energy need by the second choice is higher 13.59% than the one of the first choice ($PEN(a) = 13.59\%$).

The reason is that from Fig. 6.2a, the driving distance from P1 to P4 (s_{d14}) is bigger than the one from P1 to P2 (s_{d12}) and the driving distance from P3 to P2 (s_{d32}) is bigger than the one from P3 to P4 (s_{d34}) ($s_{d14} > s_{d12}$ and $s_{d32} > s_{d34}$). Therefore, from Equation (6.3) and (6.6), it is easy to know $t_{TDC2} - t_{TDC1} > 0$ and $E_{TDC2} - E_{TDC1} > 0$. It means that, the efficiencies of the energy need and the moving time of the first choice (P1P2 & P3P4) in this case are higher than the one of the second choice.

Case	Storage positions	Retrieval positions	Combination of two pairs	Total driving and lifting energy need (kWs)	PEN (%)	Total driving and lifting time (s)	PMT (%)
a	a6 & a24	a13 & a17	a6a13 & a24a17	127.65	13.59	28.6	8.39
			a6a17 & a24a13	145		31	
b	a13 & a17	a6 & a24	a13a6 & a17a24	127.51	13.60	28.6	8.39
			a13a24 & a17a6	144.85		31	
c	a6 & a17	a13 & a24	a6a13 & a17a24	126.36	14.93	28.6	8.57
			a6a24 & a17a13	145.22		31.05	
d	a13 & a24	a6 & a17	a13a6 & a24a17	128.8	15.05	28.6	8.57
			a13a17 & a24a6	148.19		31.05	
e	a6 & a13	a17 & a24	a6a17 & a13a24	144.28	1.35	31	0.16
			a6a24 & a13a17	146.23		31.05	
f	a17 & a24	a6 & a13	a17a6 & a24a13	145.57	1.11	31	0.16
			a17a13 & a24a6	147.18		31.05	

Table 6.1: Some examples to determine logical choice method among four positions, when

$$v_{dinp} = 4 \text{ m/s} \text{ and } a_{dinp} = 3 \text{ m/s}^2.$$

Case b: when P1 and P3 are in between P2 and P4 horizontally (Fig. 6.2b)

The farthest storage position P3 is chosen in a pair with the farthest retrieval position P4 and P1 is chosen in a pair with P2. After that, the efficiencies of the energy need and the moving time are better than the second way, e.g. Table 6.1 Case b: $PMT(b) = 8.39\%$ and $PEN(b) = 13.6\%$. The reason is that from Fig. 6.2b, $s_{d14} > s_{d34}$ and $s_{d32} > s_{d12}$. Therefore, from Equation (6.3) and (6.6), it is easy to know $t_{TDC2} - t_{TDC1} > 0$ and $E_{TDC2} - E_{TDC1} > 0$. It means that, the efficiencies of the energy need and the moving time of the first choice (P1P2 & P3P4) in this case are higher.

Case c: when P2 is in between P1 and P3 horizontally, P4 is the farthest (Fig. 6.2c)

The farthest storage position P3 is chosen in a pair with the farthest retrieval position P4 and P1 is chosen in a pair with P2. After that, the efficiencies of the energy need and the moving time are better than the second way, e.g. Table 6.1 Case c: $PMT(c) = 8.57\%$ and $PEN(c) = 14.93\%$. The reason is that from Fig. 6.2c, $s_{d14} > s_{d12} + s_{d34}$. Therefore, from Equation (6.3) and (6.6), it is easy to know $t_{TDC2} - t_{TDC1} > 0$ and $E_{TDC2} - E_{TDC1} > 0$. It means that, the efficiencies of the energy need and the moving time of the first choice (P1P2 & P3P4) in this case are higher.

Case d: when P1 is in between P2 and P4 horizontally, P3 is the farthest (Fig. 6.2d)

The farthest storage position P3 is chosen in a pair with the farthest retrieval position P4 and P1 is chosen in a pair with P2. After that, the efficiency of the energy need and the moving time are better than the second way, e.g. Table 6.1 Case d: $PMT(d) = 8.57\%$ and $PEN(d) = 15.05\%$. The reason is that from Fig. 6.2d, $s_{d32} > s_{d12} + s_{d34}$. Therefore, from Equation (6.3) and (6.6), it is easy to know $t_{TDC2} - t_{TDC1} > 0$ and $E_{TDC2} - E_{TDC1} > 0$. It means that, the efficiencies of the energy need and the moving time of the first choice (P1P2 & P3P4) in this case are higher.

Case e,f: when P1 and P3 are on the same side, P2 and P4 are on the other side (Fig. 6.2e,f)

The results of the energy need and the moving time of the two options are nearly equal e.g. Table 6.1 Case e: $PMT(e) = 0.16\%$ and $PEN(e) = 1.35\%$; Table 6.1 Case f: $PMT(f) = 0.16\%$ and $PEN(f) = 1.11\%$. The reason is that from Fig. 6.2e,f, $s_{d14} + s_{d32} = s_{d12} + s_{d34}$. Therefore, from Equation (6.3) and (6.6), $t_{TDC2} \approx t_{TDC1}$ and $E_{TDC2} \approx E_{TDC1}$. It is only slightly different due to the different starting and braking distances or due to influence of the energy need and the lifting time of the lifting unit by the height of the different compartments.

6.1.3 Synthesizing the logical choice method among positions of double operation cycle

From 6 cases in Section 6.1.2, the general method to choose two pairs of DOC from any four positions to achieve the best efficiencies of the energy need and the moving time is shown: the farthest storage position is chosen in a pair with the farthest retrieval position and the remaining storage position is chosen in a pair with the remaining retrieval position.

From this result and the conclusion in Chapter 5: The farther from the I/O point a storage position and a retrieval position chosen for a pair of DOC are and the nearer to each other by horizontal direction they are, the higher the saving efficiencies of the energy need and the moving time in DOC are. The method to choose the pairs of DOC can be extended to the entire system based on the inductive approach to achieve the best efficiencies of the energy need and the moving time (Appendix C). This method is shown that *the farthest storage compartment and the farthest retrieval compartment by horizontal direction are always selected as the first pair and then the second pair is selected at the second farthest storage and retrieval compartments and so on. Finally, the storage and retrieval compartments at the nearest positions to the I/O point by horizontal direction are chosen.* After that, the system achieves the best efficiencies of the energy need and the moving time in DOC.

This method is only applied when SRV has an energy recovery system and the system's height is just average. If the system is high and then the energy efficiency of this method is still suitable due to the energy recovery rate of the lifting unit is about 70% the lifting unit energy consumption on every height. However, the lifting time is quite big and it directly affects to the total working time then the saving efficiency of the moving time is not high. In this case, depending on the height of the system, it is possible to divide the system into zones of height and this method is applied in each zone. After that, the saving efficiencies of the energy need and the moving time can be still suitable.

6.2 Efficiencies of the logical choice method among the positions in the double operation cycle

To improve productivity and save energy need, the logical choice method of the pairs of DOC in the entire system is shown in Section 6.1. This method is compared with the chaotic storage method when the system is divided by the time ABC zoning, the energy ABC zoning or the non-zoning to prove its advantages. When two methods are compared to each other, the kinematic parameters of the lifting unit are chosen at maximum values. Thereafter, the lifting time affects a little bit to the total operating time and the logical choice method is better (in general, the kinematic parameters of the lifting unit can be controlled so that the lifting time suits the moving time, which all lifting unit and driving unit simultaneously arrive at the destination to reduce the machine parts' wear and achieve the best energy efficiency by the required throughput [73]).

To meet the different practical conditions, the required unit loads for storage and retrieval are considered at different values when the driving unit speed changes. The comparison between two methods is based on the random selection process of the required numbers of the storage and retrieval compartments.

The first way is the chaotic storage in the chosen compartments and the average values of the throughput and the energy need are determined in each case of the driving unit speed and the number of the storage and retrieval compartments. The second way is applied by the logical choice method in the chosen compartments and average values of the throughput and the energy need are determined in each case. The average throughput and the average energy need of two methods are compared to each other. Effective percentages of the throughput and the energy need of the logical choice method are shown accordingly.

A simulation model is established to calculate the average values of the throughput and the energy need of two methods based on the results of the simulation models of SOC and DOC shown in Chapter 3 and Chapter 4. This simulation model determines every average value of the throughput and the energy need when the system is divided by the time ABC zoning, the energy ABC zoning or non-zoning.

6.2.1 Efficiency of the logical choice method when the system is the non-zoning

From the results of the simulation model, the average effective percentages of the throughput and the energy need of the logical choice method compared to the ones of the chaotic storage method of DOC are shown.

The average effective percentage $\overline{\Delta Q_{LC}}$ of the throughput $\overline{Q_{LOG}}$ of the logical choice method compared with the throughput $\overline{Q_{DC}}$ of the chaotic storage method is shown by Table 6.2 and Figure 6.3 when the number of DOCs increases from 20 to 400 cycles and the driving unit speed increases from 2 m/s to 5 m/s. Besides, the average effective percentage $\overline{\Delta E_{LC}}$ of the energy need $\overline{E_{LOG}}$ of the logical choice method compared with the energy need $\overline{E_{DC}}$ of the chaotic storage method is shown by Table 6.3 and Fig. 6.4.

The average effective percentage of the throughput $\overline{\Delta Q_{LC}}$ of the logical choice method increases when the driving unit speed decreases, e.g. Fig 6.3, $\overline{\Delta Q_{LC}}$ increases from 3.8 ÷ 5.2% at 5 m/s and up to 6.8 ÷ 8.4% at 2 m/s. Besides, when the driving unit speed increases, the average effective percentage of the throughput tends to change less. The average effective percentage of the throughput $\overline{\Delta Q_{LC}}$ only changes slightly when the speed is constant and the required number of DOCs changes. When the required number of DOCs is low and the speed is high and then $\overline{\Delta Q_{LC}}$ is quite low, e.g. Fig. 6.3, DOC's number is 20 cycles and $v_{dimp} = 5$ m/s then $\overline{\Delta Q_{LC}} = 3.8\%$.

$v_{d\text{inp}}$	2 m/s			3 m/s			4 m/s			5 m/s		
	$\overline{Q_{DC}}$ (UL/h)	$\overline{Q_{LOG}}$ (UL/h)	$\overline{\Delta Q_{LC}}$ (%)	$\overline{Q_{DC}}$ (UL/h)	$\overline{Q_{LOG}}$ (UL/h)	$\overline{\Delta Q_{LC}}$ (%)	$\overline{Q_{DC}}$ (UL/h)	$\overline{Q_{LOG}}$ (UL/h)	$\overline{\Delta Q_{LC}}$ (%)	$\overline{Q_{DC}}$ (UL/h)	$\overline{Q_{LOG}}$ (UL/h)	$\overline{\Delta Q_{LC}}$ (%)
20	185.1	197.6	6.8	206.9	217.2	5.0	217.1	226.1	4.1	221.6	230.1	3.8
40	185	198.9	7.5	206.9	218.3	5.5	217.0	227.2	4.7	221.6	231.3	4.3
60	185	199.3	7.8	206.8	218.7	5.7	217.0	227.6	4.9	221.6	231.7	4.6
80	185	199.6	7.9	206.9	219.0	5.9	217.0	228.0	5.0	221.6	232.0	4.7
100	185	199.8	8.0	206.8	219.1	6.0	217.0	228.2	5.1	221.6	232.2	4.8
120	185	199.9	8.1	206.8	219.3	6.0	217.0	228.3	5.2	221.6	232.4	4.9
140	185	200.0	8.1	206.9	219.4	6.1	217.0	228.4	5.2	221.6	232.5	4.9
160	184.9	200.0	8.2	206.8	219.5	6.1	217.0	228.5	5.3	221.6	232.6	5.0
180	185	200.1	8.2	206.8	219.5	6.1	217.0	228.6	5.3	221.6	232.7	5.0
200	185	200.2	8.2	206.8	219.6	6.2	217.0	228.6	5.3	221.6	232.8	5.0
220	184.9	200.2	8.3	206.8	219.6	6.2	217.0	228.7	5.4	221.6	232.8	5.1
240	184.9	200.2	8.3	206.8	219.6	6.2	217.0	228.7	5.4	221.6	232.9	5.1
260	184.9	200.3	8.3	206.9	219.7	6.2	217.0	228.8	5.4	221.6	232.9	5.1
280	184.9	200.3	8.3	206.8	219.8	6.2	217.0	228.8	5.4	221.6	232.9	5.1
300	184.9	200.3	8.3	206.8	219.8	6.3	217.0	228.8	5.4	221.6	233.0	5.1
320	184.9	200.3	8.3	206.8	219.8	6.3	217.0	228.8	5.5	221.6	233.0	5.2
340	184.9	200.4	8.3	206.8	219.9	6.3	217.0	228.8	5.5	221.6	233.0	5.2
360	184.9	200.4	8.4	206.8	219.9	6.3	217.0	228.9	5.5	221.6	233.0	5.2
380	184.9	200.4	8.4	206.8	219.9	6.3	217.0	228.9	5.5	221.6	233.1	5.2
400	184.9	200.4	8.4	206.8	219.9	6.3	217.0	228.9	5.5	221.6	233.1	5.2

Table 6.2: Comparison average throughput per hour between chaotic storage method and logical choice method in DOC when the system is the non-zoning.

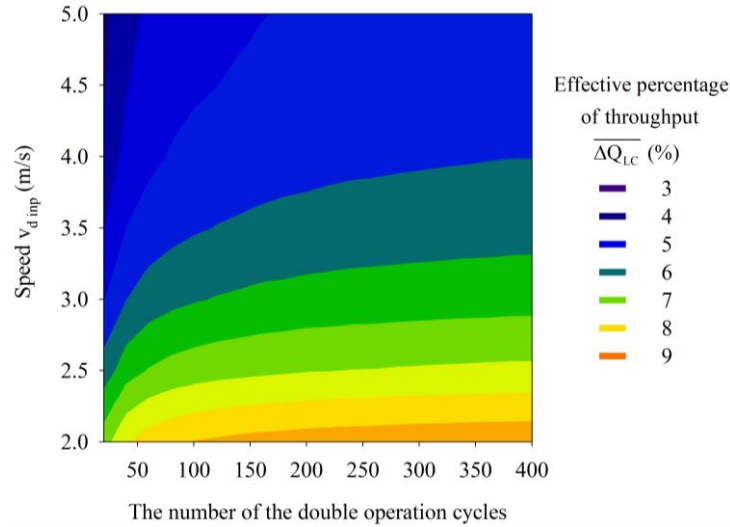

Figure 6.3: Average effective percentage of throughput in DOC of the logical choice method when the system is the non-zoning.

The average effective percentage of the energy need $\overline{\Delta E_{LC}}$ of the logical choice method in this case is quite high (15-21%) with every speed and the required number of DOCs. When the required number of DOCs increases, the average effective percentage of the energy

need tends to change less. $\overline{\Delta E_{LC}}$ only changes slightly when the speed changes and the required number of DOCs is constant, e.g. Fig. 6.4 when DOC's number is 80 cycles and the speed increases from 2 m/s to 5 m/s then $\overline{\Delta E_{LC}}$ only increases from 18.5% to 19.5%.

In general, when the number of DOCs increases and the driving unit speed is constant and then the average effective percentage of the throughput of the logical choice method only changes slightly and the average effective percentage of the energy need increases. It means that the logical choice method achieves the high efficiency of the energy need when the number of DOCs is big and the speed is constant. However, when the number of DOCs is quite big, the average effective percentage of the energy need does not change much. The average effective percentage of the throughput drops fast and the average effective percentage of the energy need changes a little bit when the number of DOCs is constant and the speed increases.

As a result, when the required number of DOCs is small and the driving unit speed is high, the main advantage of the logical choice method is the energy need. When the required number of DOCs is big and the driving unit speed is small, the average effective percentages of the throughput and the energy need are high.

$V_{d\text{inp}}$	2 m/s			3 m/s			4 m/s			5 m/s		
DOCs	$\overline{E_{DC}}$ (kW/s/UL)	$\overline{E_{LOG}}$ (kW/s/UL)	$\overline{\Delta E_{LC}}$ (%)	$\overline{E_{DC}}$ (kW/s/UL)	$\overline{E_{LOG}}$ (kW/s/UL)	$\overline{\Delta E_{LC}}$ (%)	$\overline{E_{DC}}$ (kW/s/UL)	$\overline{E_{LOG}}$ (kW/s/UL)	$\overline{\Delta E_{LC}}$ (%)	$\overline{E_{DC}}$ (kW/s/UL)	$\overline{E_{LOG}}$ (kW/s/UL)	$\overline{\Delta E_{LC}}$ (%)
20	20.3	17.2	-15.5	25.2	21.1	-16.3	28.9	24.1	-16.7	31.3	26.0	-16.8
40	20.3	16.8	-17.3	25.2	20.6	-18.0	28.9	23.6	-18.4	31.3	25.5	-18.5
60	20.3	16.7	-18.1	25.2	20.4	-18.8	28.9	23.4	-19.1	31.3	25.3	-19.2
80	20.3	16.6	-18.5	25.1	20.3	-19.3	28.9	23.2	-19.5	31.3	25.2	-19.5
100	20.3	16.5	-18.8	25.2	20.3	-19.5	28.9	23.1	-19.8	31.3	25.1	-19.7
120	20.3	16.5	-19.0	25.2	20.2	-19.7	28.9	23.1	-19.9	31.3	25.0	-20.0
140	20.3	16.4	-19.2	25.1	20.1	-19.9	28.9	23.1	-20.1	31.3	25.0	-20.0
160	20.3	16.4	-19.3	25.2	20.1	-20.0	28.9	23.0	-20.2	31.3	25.0	-20.2
180	20.3	16.4	-19.4	25.2	20.1	-20.1	28.9	23.0	-20.3	31.3	24.9	-20.3
200	20.3	16.4	-19.6	25.2	20.1	-20.2	28.9	23.0	-20.4	31.3	24.9	-20.3
220	20.3	16.3	-19.6	25.2	20.1	-20.3	28.9	23.0	-20.4	31.3	24.9	-20.4
240	20.3	16.3	-19.7	25.2	20.1	-20.3	28.9	23.0	-20.5	31.3	24.9	-20.4
260	20.3	16.3	-19.7	25.1	20.0	-20.4	28.9	22.9	-20.5	31.3	24.9	-20.5
280	20.3	16.3	-19.8	25.2	20.0	-20.4	28.9	22.9	-20.5	31.3	24.9	-20.5
300	20.3	16.3	-19.9	25.2	20.0	-20.5	28.9	22.9	-20.6	31.3	24.9	-20.5
320	20.3	16.3	-19.9	25.2	20.0	-20.5	28.9	22.9	-20.6	31.3	24.9	-20.5
340	20.3	16.3	-19.9	25.1	20.0	-20.5	28.9	22.9	-20.6	31.3	24.8	-20.6
360	20.3	16.3	-20.0	25.2	20.0	-20.5	28.9	22.9	-20.7	31.3	24.8	-20.6
380	20.3	16.3	-20.0	25.2	20.0	-20.6	28.9	22.9	-20.7	31.3	24.8	-20.6
400	20.3	16.3	-20.0	25.2	20.0	-20.6	28.9	22.9	-20.7	31.3	24.8	-20.6

Table 6.3: Comparison average energy need per unit load between chaotic storage method and logical choice method in DOC when the system is the non-zoning.

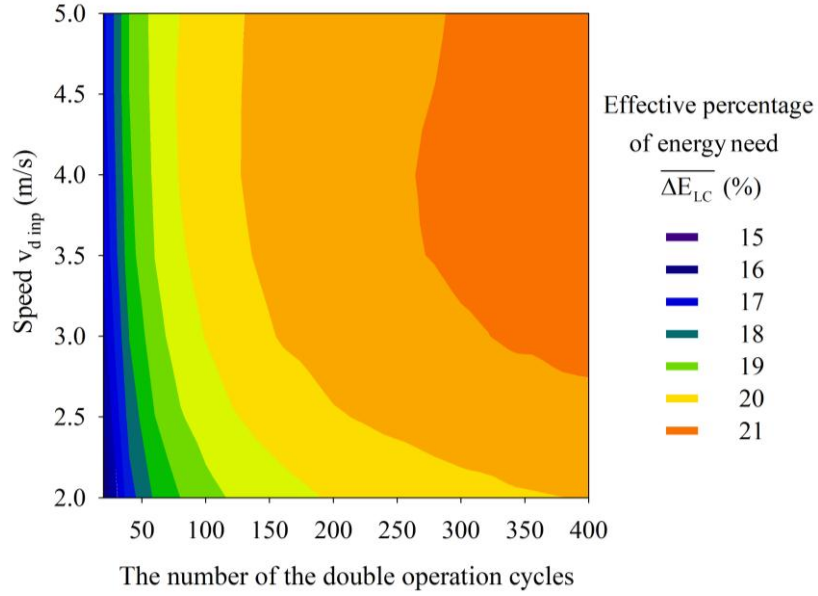

Figure 6.4: Average effective percentage of energy need per unit load in DOC of the logical choice method when the system is the non-zoning.

6.2.2 Efficiency of the logical choice method when the system is divided by the ABC zonings

The ABC zonings of the system are divided by the time ABC zoning and the energy ABC zoning. The time ABC zoning is determined by the moving time of SRV from the I/O point to the storage and retrieval compartments and the energy ABC zoning is determined by total energy need of SRV when it moves from the I/O point to the storage and retrieval compartments and then back from the storage and retrieval compartments to the I/O point. The ratio of three zones is equally divided by 1/3: 1/3: 1/3. The average throughput and the average energy need are two criteria for evaluating the efficiencies of the logical choice method.

6.2.2.1 When the system is divided by the time ABC zoning

The time ABC zoning is determined by Figure D.1 - Appendix D when kinematic parameters of the lifting unit are maximum values ($v_{l\text{imp}} = v_{l\text{max}} = 4 \text{ m/s}$ and $a_{l\text{imp}} = a_{l\text{max}} = 4 \text{ m/s}^2$) and the driving unit speed changes from 2 m/s to 5 m/s. The average effective percentage $\overline{\Delta Q_{LCABCt}}$ of the throughput $\overline{Q_{LOGABCt}}$ of the logical choice method compared with throughput $\overline{Q_{DCABCt}}$ of the chaotic storage method is shown by Table 6.4 and Fig. 6.5 when the number of DOCs increases from 20 to 400 cycles and the driving unit speed increases from 2 m/s to 5 m/s. The average effective percentage $\overline{\Delta E_{LCABCt}}$ of the energy need $\overline{E_{LOGABCt}}$ of the logical choice method compared with the energy need $\overline{E_{DCABCt}}$ of the chaotic storage method is shown by Table 6.5 and Fig. 6.6.

$v_{d\text{inp}}$	2 m/s			3 m/s			4 m/s			5 m/s		
	$\overline{Q_{DCABCt}}$ (UL/h)	$\overline{Q_{LOGABCt}}$ (UL/h)	$\overline{\Delta Q_{LCABCt}}$ (%)	$\overline{Q_{DCABCt}}$ (UL/h)	$\overline{Q_{LOGABCt}}$ (UL/h)	$\overline{\Delta Q_{LCABCt}}$ (%)	$\overline{Q_{DCABCt}}$ (UL/h)	$\overline{Q_{LOGABCt}}$ (UL/h)	$\overline{\Delta Q_{LCABCt}}$ (%)	$\overline{Q_{DCABCt}}$ (UL/h)	$\overline{Q_{LOGABCt}}$ (UL/h)	$\overline{\Delta Q_{LCABCt}}$ (%)
20	231.6	235.5	1.6	243.2	246.3	1.3	246.7	249.8	1.2	247.8	250.9	1.3
40	231.7	236.1	1.9	243.1	246.8	1.5	246.7	250.3	1.5	247.8	251.5	1.5
60	231.7	236.3	2.0	243.1	247.0	1.6	246.7	250.6	1.6	247.8	251.7	1.6
80	231.6	236.4	2.1	243.1	247.2	1.7	246.7	250.8	1.6	247.8	251.9	1.7
100	231.7	236.5	2.1	243.1	247.3	1.7	246.7	250.8	1.7	247.8	252.0	1.7
120	231.7	236.6	2.1	243.1	247.4	1.7	246.7	250.9	1.7	247.8	252.1	1.7
140	231.7	236.7	2.2	243.1	247.4	1.8	246.7	251.0	1.7	247.8	252.1	1.7
160	231.6	236.7	2.2	243.1	247.5	1.8	246.7	251.0	1.8	247.8	252.2	1.8
180	231.7	236.7	2.2	243.1	247.5	1.8	246.7	251.1	1.8	247.8	252.2	1.8
200	231.7	236.8	2.2	243.1	247.5	1.8	246.7	251.1	1.8	247.8	252.3	1.8
220	231.6	236.8	2.2	243.1	247.6	1.8	246.7	251.1	1.8	247.8	252.3	1.8
240	231.7	236.8	2.2	243.1	247.6	1.8	246.7	251.2	1.8	247.8	252.3	1.8
260	231.7	236.8	2.2	243.1	247.6	1.8	246.7	251.2	1.8	247.8	252.3	1.8
280	231.7	236.9	2.2	243.1	247.6	1.8	246.7	251.2	1.8	247.8	252.4	1.8
300	231.7	236.9	2.3	243.1	247.6	1.9	246.7	251.2	1.8	247.8	252.4	1.8
320	231.7	236.9	2.3	243.1	247.6	1.9	246.7	251.2	1.8	247.8	252.4	1.8
340	231.7	236.9	2.3	243.1	247.7	1.9	246.7	251.2	1.8	247.8	252.4	1.9
360	231.7	236.9	2.3	243.1	247.7	1.9	246.7	251.3	1.9	247.8	252.4	1.9
380	231.6	236.9	2.3	243.1	247.7	1.9	246.7	251.3	1.9	247.8	252.4	1.9
400	231.7	236.9	2.3	243.1	247.7	1.9	246.7	251.3	1.9	247.8	252.4	1.9

Table 6.4: Comparison average throughput per hour between chaotic storage method and logical choice method in DOC of the time ABC zoning.

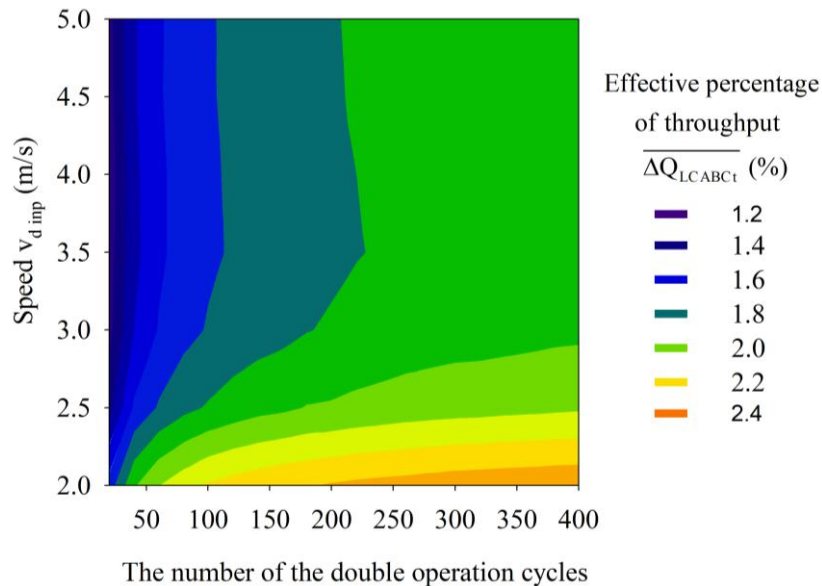

Figure 6.5: Average effective percentage of throughput in DOC of the logical choice method when the system is divided by the time ABC zoning.

The effective percentage of the throughput $\overline{\Delta Q_{LCABCt}}$ of the logical choice method is quite small and almost unchanged when the driving unit speed increases highly and the number of DOCs is constant. $\overline{\Delta Q_{LCABCt}}$ increases slightly when the driving unit speed is low. It means that the logical choice method in the time ABC zoning affects a little bit to the throughput for every required number of DOCs.

The average effective percentage of the energy need $\overline{\Delta E_{LCABCt}}$ in this case increases when the required number of DOCs increases and the driving unit speed is constant, e.g. Fig. 6.6, DOC's number increases from 20 to 400 cycles and $v_{dimp} = 3\text{ m/s}$ then $\overline{\Delta E_{LCABCt}}$ increases from 8.0% to 11.4%. Otherwise, when the number of DOCs is quite big, the average effective percentage of the energy need changes a little bit, e.g. Fig. 6.6, DOC's number increases from 200 to 400 cycles and $v_{dimp} = 4\text{ m/s}$ then $\overline{\Delta E_{LCABCt}}$ increases from 10.7% to 11%. $\overline{\Delta E_{LCABCt}}$ changes a little bit when the driving unit speed changes and the required number of DOCs is constant.

DOCs	v_{dimp} 2 m/s			v_{dimp} 3 m/s			v_{dimp} 4 m/s			v_{dimp} 5 m/s		
	$\overline{E_{DCABCt}}$ (kW/s/UL)	$\overline{E_{LOGABCt}}$ (kW/s/UL)	$\overline{\Delta E_{LCABCt}}$ (%)	$\overline{E_{DCABCt}}$ (kW/s/UL)	$\overline{E_{LOGABCt}}$ (kW/s/UL)	$\overline{\Delta E_{LCABCt}}$ (%)	$\overline{E_{DCABCt}}$ (kW/s/UL)	$\overline{E_{LOGABCt}}$ (kW/s/UL)	$\overline{\Delta E_{LCABCt}}$ (%)	$\overline{E_{DCABCt}}$ (kW/s/UL)	$\overline{E_{LOGABCt}}$ (kW/s/UL)	$\overline{\Delta E_{LCABCt}}$ (%)
20	10.6	9.7	-7.7	12.4	11.4	-8.0	13.5	12.5	-7.9	14.1	13.0	-7.6
40	10.5	9.6	-9.0	12.4	11.2	-9.3	13.5	12.3	-9.1	14.1	12.8	-8.8
60	10.6	9.5	-9.6	12.4	11.1	-9.9	13.5	12.2	-9.6	14.1	12.8	-9.3
80	10.6	9.5	-10.0	12.4	11.1	-10.3	13.5	12.2	-10.0	14.1	12.7	-9.6
100	10.6	9.5	-10.3	12.4	11.1	-10.5	13.5	12.2	-10.2	14.1	12.7	-9.8
120	10.5	9.4	-10.5	12.4	11.1	-10.6	13.5	12.1	-10.3	14.1	12.7	-9.9
140	10.5	9.4	-10.6	12.4	11.0	-10.8	13.5	12.1	-10.4	14.1	12.6	-10.1
160	10.6	9.4	-10.7	12.4	11.0	-10.8	13.5	12.1	-10.5	14.1	12.6	-10.1
180	10.5	9.4	-10.8	12.4	11.0	-11.0	13.5	12.1	-10.6	14.1	12.6	-10.2
200	10.5	9.4	-10.9	12.4	11.0	-11.0	13.5	12.1	-10.7	14.1	12.6	-10.3
220	10.6	9.4	-10.9	12.4	11.0	-11.1	13.5	12.1	-10.7	14.1	12.6	-10.3
240	10.5	9.4	-11.0	12.4	11.0	-11.1	13.5	12.1	-10.8	14.1	12.6	-10.4
260	10.5	9.4	-11.0	12.4	11.0	-11.2	13.5	12.1	-10.8	14.1	12.6	-10.4
280	10.5	9.4	-11.1	12.4	11.0	-11.2	13.5	12.1	-10.8	14.1	12.6	-10.5
300	10.5	9.4	-11.1	12.4	11.0	-11.3	13.5	12.1	-10.9	14.1	12.6	-10.5
320	10.5	9.4	-11.2	12.4	11.0	-11.3	13.5	12.1	-10.9	14.1	12.6	-10.5
340	10.5	9.4	-11.2	12.4	11.0	-11.3	13.5	12.1	-10.9	14.1	12.6	-10.5
360	10.5	9.4	-11.2	12.4	11.0	-11.3	13.5	12.1	-10.9	14.1	12.6	-10.6
380	10.6	9.4	-11.3	12.4	11.0	-11.4	13.5	12.1	-11.0	14.1	12.6	-10.6
400	10.5	9.4	-11.3	12.4	11.0	-11.4	13.5	12.1	-11.0	14.1	12.6	-10.6

Table 6.5: Comparison average energy need per unit load between chaotic storage method and logical choice method in DOC of the time ABC zoning.

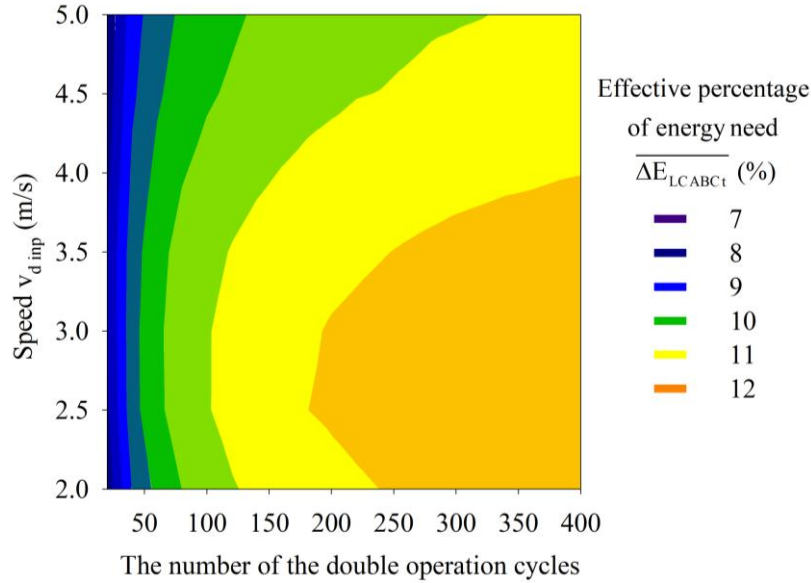

Figure 6.6: Average effective percentage of the energy need per unit load in DOC of the logical choice method when the system is divided by the time ABC zoning.

The average effective percentage of the energy need is slightly higher when the speed is within 2.5 ÷ 3 m/s. It means that the energy efficiency of the logical choice method is integrated better at these speeds in the time ABC zoning. The reason is that the unit loads focus mainly in zone A and then the driving unit moves a lot in the distances for only the startup and braking phases. The energy need of the driving unit could be affected a little bit by these distances when the driving unit speed changes.

In general, when the logical choice method is applied in the time ABC zoning, the energy need achieves high efficiency at every speed of the driving unit and the effective percentage of the throughput is negligible.

6.2.2.2 When the system is divided by the energy ABC zoning

When the kinematic parameters of the lifting unit are maximum values and the driving unit speed changes from 2 m/s to 5 m/s, the energy ABC zonings are determined from Figure D.2 to D.4 - Appendix D. The average throughput $\overline{Q_{LOGABCt}}$ and the average energy need $\overline{E_{LOGABCt}}$ of the time ABC zoning are compared to the average throughput $\overline{Q_{LOGABCE}}$ and the average energy need $\overline{E_{LOGABCE}}$ of the energy ABC zoning when the logical choice method is used in both ways to determine which division is better. The average throughput and the average energy need of the two methods are compared to each other and shown in Table 6.6 and Table 6.7 when the number of DOCs increases from 20 to 200 cycles and the driving unit speed increases from 2 m/s to 5 m/s.

$v_{d\text{inp}}$	2 m/s			3 m/s			4 m/s			5 m/s		
DOCs	$\overline{Q}_{LOGABC1}$ (UL/h)	$\overline{Q}_{LOGABCE}$ (UL/h)	$\overline{\Delta Q}_{E-1}$ (%)	$\overline{Q}_{LOGABC1}$ (UL/h)	$\overline{Q}_{LOGABCE}$ (UL/h)	$\overline{\Delta Q}_{E-1}$ (%)	$\overline{Q}_{LOGABC1}$ (UL/h)	$\overline{Q}_{LOGABCE}$ (UL/h)	$\overline{\Delta Q}_{E-1}$ (%)	$\overline{Q}_{LOGABC1}$ (UL/h)	$\overline{Q}_{LOGABCE}$ (UL/h)	$\overline{\Delta Q}_{E-1}$ (%)
20	235.5	234.5	-0.4	246.3	245.4	-0.4	249.8	249.1	-0.3	250.9	250.3	-0.2
40	236.1	235.2	-0.4	246.8	246.0	-0.4	250.3	249.8	-0.4	251.5	250.9	-0.4
60	236.3	235.6	-0.3	247.0	246.3	-0.3	250.6	250.1	-0.3	251.7	251.3	-0.3
80	236.4	235.8	-0.3	247.2	246.5	-0.3	250.8	250.3	-0.3	251.9	251.4	-0.3
100	236.5	235.9	-0.3	247.3	246.7	-0.3	250.8	250.4	-0.3	252.0	251.6	-0.3
120	236.6	236.0	-0.3	247.4	246.7	-0.3	250.9	250.5	-0.3	252.1	251.7	-0.3
140	236.7	236.1	-0.3	247.4	246.8	-0.3	251.0	250.6	-0.3	252.1	251.8	-0.3
160	236.7	236.1	-0.3	247.5	246.9	-0.3	251.0	250.7	-0.3	252.2	251.8	-0.3
180	236.7	236.2	-0.2	247.5	246.9	-0.2	251.1	250.7	-0.2	252.2	251.9	-0.2
200	236.8	236.2	-0.3	247.5	247.0	-0.3	251.1	250.7	-0.3	252.3	251.9	-0.3

Table 6.6: Comparison average throughput between the time ABC zoning and the energy ABC zoning in the logical choice method of DOC.

$v_{d\text{inp}}$	2 m/s			3 m/s			4 m/s			5 m/s		
DOCs	$\overline{E}_{LOGABC1}$ (kW/s/UL)	$\overline{E}_{LOGABCE}$ (kW/s/UL)	$\overline{\Delta E}_{E-1}$ (%)	$\overline{E}_{LOGABC1}$ (kW/s/UL)	$\overline{E}_{LOGABCE}$ (kW/s/UL)	$\overline{\Delta E}_{E-1}$ (%)	$\overline{E}_{LOGABC1}$ (kW/s/UL)	$\overline{E}_{LOGABCE}$ (kW/s/UL)	$\overline{\Delta E}_{E-1}$ (%)	$\overline{E}_{LOGABC1}$ (kW/s/UL)	$\overline{E}_{LOGABCE}$ (kW/s/UL)	$\overline{\Delta E}_{E-1}$ (%)
20	9.7	9.9	2.06	11.4	11.65	2.19	12.5	12.80	2.40	13.0	13.37	2.85
40	9.6	9.7	1.04	11.2	11.48	2.50	12.3	12.60	2.44	12.8	13.19	3.05
60	9.5	9.7	2.11	11.1	11.40	2.70	12.2	12.51	2.54	12.8	13.11	2.42
80	9.5	9.6	1.05	11.1	11.35	2.25	12.2	12.47	2.21	12.7	13.06	2.83
100	9.5	9.6	1.05	11.1	11.31	1.89	12.2	12.44	1.97	12.7	13.02	2.52
120	9.4	9.6	2.13	11.1	11.29	1.71	12.1	12.41	2.56	12.7	13.00	2.36
140	9.4	9.5	1.06	11.0	11.28	2.55	12.1	12.40	2.48	12.6	12.99	3.10
160	9.4	9.5	1.06	11.0	11.26	2.36	12.1	12.38	2.31	12.6	12.97	2.94
180	9.4	9.5	1.06	11.0	11.25	2.27	12.1	12.37	2.23	12.6	12.96	2.86
200	9.4	9.5	1.06	11.0	11.24	2.18	12.1	12.36	2.15	12.6	12.95	2.78

Table 6.7: Comparison average energy need between the time ABC zoning and the energy ABC zoning in the logical choice method of DOC.

The average throughput of the time ABC zoning is a little bit bigger than the one of the energy ABC zoning, e.g. Table 6.6, the effective percentage of the throughput $\overline{\Delta Q}_{E-1}$ of the time ABC zoning compared to the one of the energy ABC zoning changes from 0.2 to 0.4% when the driving unit speed increases from 2 m/s to 5 m/s. The average energy need of the time ABC zoning is a little bit smaller than the one of the energy ABC zoning, e.g. Table 6.7, the effective percentage of the energy need $\overline{\Delta E}_{E-1}$ of the time ABC zoning compared to the one of the energy ABC zoning changes from 1 to 3% when the driving unit speed increases from 2 m/s to 5 m/s. The reason is that the kinematic parameters of the

lifting unit are chosen at maximum values and then the division of the time ABC zoning and of the energy ABC zoning is roughly the same when the driving unit speed changes from 2 m/s to 5 m/s. In addition, the time ABC zoning is not separated by height resulting in the application of this method is more reasonable due to the average distance of P1P2 in the horizontal $\overline{s_{dP1P2}}$ of the energy ABC zoning is greater than the one of the time ABC zoning. As a result, the efficiencies of the average throughput and the average energy need of the energy ABC zoning are a little bit lower than the ones of the time ABC zoning. It means that the time ABC zoning is used for calculating the average throughput and the average energy need of the logical choice method in DOC.

After the average effective percentages of the throughput per hour and the energy need per unit load of the logical choice method are determined, the average effective percentage of the energy need per hour is shown by Table 6.8 and Fig. 6.7 when the system is the non-zoning and shown by Table 6.9 and Fig. 6.8 when the system is divided by the time ABC zoning. The saving efficiency of the energy need is accordingly determined more specifically.

v_{dimp}	2 m/s			3 m/s			4 m/s			5 m/s		
DOCs	$\overline{E_{DC_h}}$ (kWh/h)	$\overline{E_{LOG_h}}$ (kWh/h)	$\overline{\Delta E_{LC_h}}$ (%)	$\overline{E_{DC_h}}$ (kWh/h)	$\overline{E_{LOG_h}}$ (kWh/h)	$\overline{\Delta E_{LC_h}}$ (%)	$\overline{E_{DC_h}}$ (kWh/h)	$\overline{E_{LOG_h}}$ (kWh/h)	$\overline{\Delta E_{LC_h}}$ (%)	$\overline{E_{DC_h}}$ (kWh/h)	$\overline{E_{LOG_h}}$ (kWh/h)	$\overline{\Delta E_{LC_h}}$ (%)
20	1.05	0.94	-9.83	1.45	1.27	-12.15	1.74	1.51	-13.24	1.93	1.66	-13.67
40	1.04	0.93	-11.12	1.45	1.25	-13.51	1.74	1.49	-14.62	1.92	1.64	-14.97
60	1.04	0.92	-11.71	1.45	1.24	-14.15	1.74	1.48	-15.14	1.93	1.63	-15.47
80	1.04	0.92	-12.06	1.45	1.24	-14.51	1.74	1.47	-15.48	1.93	1.62	-15.71
100	1.04	0.92	-12.33	1.45	1.23	-14.72	1.74	1.47	-15.69	1.93	1.62	-15.89
120	1.04	0.91	-12.50	1.45	1.23	-14.91	1.74	1.47	-15.79	1.93	1.62	-16.04
140	1.04	0.91	-12.64	1.45	1.23	-15.03	1.74	1.46	-15.90	1.92	1.62	-16.10
160	1.04	0.91	-12.74	1.45	1.23	-15.14	1.74	1.46	-15.97	1.92	1.61	-16.21
180	1.04	0.91	-12.83	1.45	1.23	-15.20	1.74	1.46	-16.05	1.93	1.61	-16.25
200	1.04	0.91	-12.93	1.45	1.22	-15.28	1.74	1.46	-16.10	1.92	1.61	-16.29
220	1.04	0.91	-13.00	1.45	1.22	-15.32	1.74	1.46	-16.13	1.93	1.61	-16.33
240	1.04	0.91	-13.05	1.45	1.22	-15.36	1.74	1.46	-16.16	1.92	1.61	-16.35
260	1.04	0.91	-13.10	1.44	1.22	-15.40	1.74	1.46	-16.19	1.92	1.61	-16.39
280	1.04	0.91	-13.15	1.45	1.22	-15.44	1.74	1.46	-16.23	1.92	1.61	-16.41
300	1.04	0.91	-13.19	1.45	1.22	-15.47	1.74	1.46	-16.26	1.93	1.61	-16.45
320	1.04	0.91	-13.21	1.45	1.22	-15.50	1.74	1.46	-16.29	1.92	1.61	-16.45
340	1.04	0.91	-13.26	1.44	1.22	-15.54	1.74	1.46	-16.29	1.92	1.61	-16.47
360	1.04	0.91	-13.29	1.45	1.22	-15.55	1.74	1.46	-16.34	1.92	1.61	-16.49
380	1.04	0.91	-13.31	1.45	1.22	-15.58	1.74	1.46	-16.35	1.93	1.61	-16.51
400	1.04	0.91	-13.34	1.45	1.22	-15.59	1.74	1.46	-16.34	1.92	1.61	-16.52

Table 6.8: Comparison average energy need per hour between chaotic storage method and logical choice method in DOC when the system is the non-zoning.

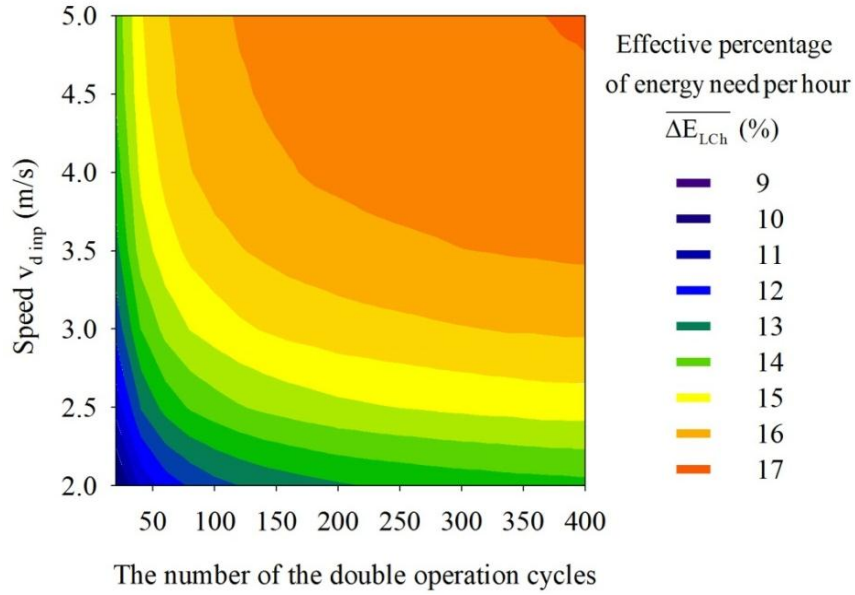

Figure 6.7: Effective percentage of energy need per hour (kWh/h) of the logical choice method when the system is the non-zoning.

$v_{d\text{ inp}}$	2 m/s			3 m/s			4 m/s			5 m/s		
	$\overline{E}_{DCABC h}$ (kWh/h)	$\overline{E}_{LOGABC h}$ (kWh/h)	$\overline{\Delta E}_{LCABC h}$ (%)	$\overline{E}_{DCABC h}$ (kWh/h)	$\overline{E}_{LOGABC h}$ (kWh/h)	$\overline{\Delta E}_{LCABC h}$ (%)	$\overline{E}_{DCABC h}$ (kWh/h)	$\overline{E}_{LOGABC h}$ (kWh/h)	$\overline{\Delta E}_{LCABC h}$ (%)	$\overline{E}_{DCABC h}$ (kWh/h)	$\overline{E}_{LOGABC h}$ (kWh/h)	$\overline{\Delta E}_{LCABC h}$ (%)
20	0.68	0.64	-6.19	0.84	0.78	-6.83	0.93	0.86	-6.71	0.97	0.91	-6.45
40	0.68	0.63	-7.31	0.84	0.77	-7.97	0.93	0.86	-7.77	0.97	0.90	-7.42
60	0.68	0.63	-7.83	0.84	0.76	-8.47	0.93	0.85	-8.20	0.97	0.89	-7.85
80	0.68	0.62	-8.15	0.84	0.76	-8.76	0.93	0.85	-8.48	0.97	0.89	-8.09
100	0.68	0.62	-8.38	0.84	0.76	-8.94	0.93	0.85	-8.64	0.97	0.89	-8.27
120	0.68	0.62	-8.55	0.84	0.76	-9.09	0.93	0.85	-8.77	0.97	0.89	-8.38
140	0.68	0.62	-8.66	0.84	0.76	-9.20	0.93	0.85	-8.87	0.97	0.89	-8.48
160	0.68	0.62	-8.76	0.84	0.76	-9.26	0.93	0.85	-8.95	0.97	0.89	-8.55
180	0.68	0.62	-8.83	0.84	0.76	-9.35	0.93	0.84	-9.01	0.97	0.88	-8.61
200	0.68	0.62	-8.91	0.84	0.76	-9.42	0.93	0.84	-9.07	0.97	0.88	-8.65
220	0.68	0.62	-8.97	0.84	0.76	-9.46	0.93	0.84	-9.10	0.97	0.88	-8.70
240	0.68	0.62	-9.02	0.84	0.76	-9.50	0.93	0.84	-9.14	0.97	0.88	-8.74
260	0.68	0.62	-9.06	0.84	0.76	-9.55	0.93	0.84	-9.19	0.97	0.88	-8.77
280	0.68	0.62	-9.10	0.84	0.76	-9.58	0.93	0.84	-9.21	0.97	0.88	-8.81
300	0.68	0.62	-9.14	0.84	0.76	-9.61	0.93	0.84	-9.24	0.97	0.88	-8.82
320	0.68	0.62	-9.17	0.84	0.76	-9.63	0.93	0.84	-9.26	0.97	0.88	-8.84
340	0.68	0.62	-9.20	0.84	0.75	-9.65	0.93	0.84	-9.29	0.97	0.88	-8.86
360	0.68	0.62	-9.22	0.84	0.75	-9.68	0.93	0.84	-9.30	0.97	0.88	-8.89
380	0.68	0.62	-9.25	0.84	0.75	-9.71	0.93	0.84	-9.32	0.97	0.88	-8.90
400	0.68	0.62	-9.26	0.84	0.75	-9.72	0.93	0.84	-9.34	0.97	0.88	-8.92

Table 6.9: Comparison average energy need per hour between chaotic storage method and logical choice method in DOC of the time ABC zoning.

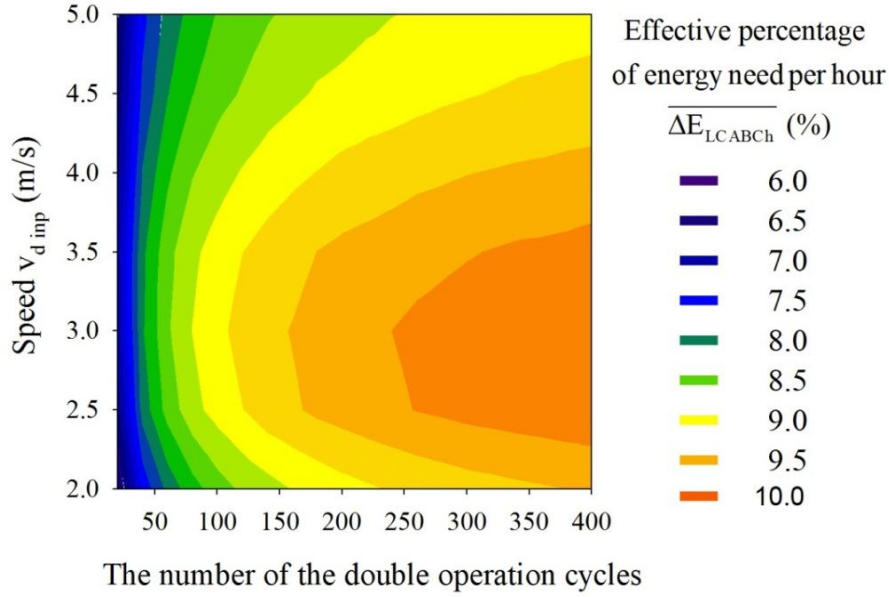

Figure 6.8: Effective percentage of energy need per hour (kWh/h) of the logical choice method when the system is divided by the time ABC zoning.

6.2.3 Average effective percentages of the storage methods in double operation cycle

The average effective percentages of the throughput and the energy need of the logical choice method among the positions in DOC compared to ones of the chaotic storage method have been determined in Section 6.2.1 and 6.2.2 when the system is divided by the time ABC zoning and the non-zoning. In this section, the storage methods in DOC are compared to each other when the system is divided by the time ABC zoning or the non-zoning and then the average effective percentages of the throughput and the energy need are shown.

6.2.3.1 Average effective percentages in the time ABC zoning compared to the non-zoning when chaotic storage method is performed

When the chaotic storage method is performed in the time ABC zoning and the non-zoning, the average effective percentage $\overline{\Delta Q_{DC_ABC-DC}}$ of the throughput $\overline{Q_{DC_ABCt}}$ of the time ABC zoning compared with the throughput $\overline{Q_{DC}}$ of the non-zoning is shown by Table 6.10 and Figure 6.9 when the number of DOCs increases from 20 to 400 cycles and the driving unit speed increases from 2 m/s to 5 m/s. Besides, the average effective percentage $\overline{\Delta E_{DC_ABC-DC}}$ of the energy need $\overline{E_{DC_ABCt}}$ of the time ABC zoning compared with the energy need $\overline{E_{DC}}$ of the non-zoning is shown by Table 6.11 and Fig. 6.10.

The average effective percentage of the throughput $\overline{\Delta Q_{DC_ABC-DC}}$ of the time ABC zoning increases highly when the driving unit speed decreases, e.g. Fig 6.9, $\overline{\Delta Q_{DC_ABC-DC}}$ increases from 11.8% at 5 m/s and up to 25.3% at 2 m/s. The average effective percentage of the

throughput $\overline{\Delta Q_{DC_ABC-DC}}$ is almost unchanged when the driving unit speed is constant and the required number of DOCs changes, e.g. Fig. 6.9, DOC's number increases from 20 to 400 cycles and $v_{d\,imp} = 4\text{m/s}$ then $\overline{\Delta Q_{DC_ABC-DC}} = 13.7\%$. The average effective percentage of the energy need $\overline{\Delta E_{DC_ABC-DC}}$ of the time ABC zoning in this case is quite high (48.1-55.1%) when the driving unit speed increases from 2 m/s to 5 m/s. It is almost unchanged when the driving unit speed is constant and the required number of DOCs changes. When the driving unit speed increases, the average effective percentages of the throughput and the energy need tend to change less.

$v_{d\,imp}$	2 m/s			3 m/s			4 m/s			5 m/s		
DOCs	$\overline{Q_{DC}}$ (UL/h)	$\overline{Q_{DC\,ABC}}$ (UL/h)	$\overline{\Delta Q_{DC_ABC-DC}}$ (%)	$\overline{Q_{DC}}$ (UL/h)	$\overline{Q_{DC\,ABC}}$ (UL/h)	$\overline{\Delta Q_{DC_ABC-DC}}$ (%)	$\overline{Q_{DC}}$ (UL/h)	$\overline{Q_{DC\,ABC}}$ (UL/h)	$\overline{\Delta Q_{DC_ABC-DC}}$ (%)	$\overline{Q_{DC}}$ (UL/h)	$\overline{Q_{DC\,ABC}}$ (UL/h)	$\overline{\Delta Q_{DC_ABC-DC}}$ (%)
20	185.1	231.6	25.2	206.9	243.2	17.5	217.1	246.7	13.7	221.6	247.8	11.8
40	185.0	231.7	25.2	206.9	243.1	17.5	217.0	246.7	13.7	221.6	247.8	11.8
60	185.0	231.7	25.2	206.8	243.1	17.5	217.0	246.7	13.7	221.6	247.8	11.8
80	185.0	231.6	25.2	206.9	243.1	17.5	217.0	246.7	13.7	221.6	247.8	11.8
100	185.0	231.7	25.2	206.8	243.1	17.6	217.0	246.7	13.7	221.6	247.8	11.8
160	184.9	231.6	25.3	206.8	243.1	17.6	217.0	246.7	13.7	221.6	247.8	11.8
200	185.0	231.7	25.3	206.8	243.1	17.6	217.0	246.7	13.7	221.6	247.8	11.8
260	184.9	231.7	25.3	206.9	243.1	17.5	217.0	246.7	13.7	221.6	247.8	11.8
300	184.9	231.7	25.3	206.8	243.1	17.6	217.0	246.7	13.7	221.6	247.8	11.8
360	184.9	231.7	25.3	206.8	243.1	17.6	217.0	246.7	13.7	221.6	247.8	11.8
400	184.9	231.7	25.3	206.8	243.1	17.6	217.0	246.7	13.7	221.6	247.8	11.8

Table 6.10: Comparison average throughput per hour between the ABC zoning and the non-zoning when the chaotic storage method is performed.

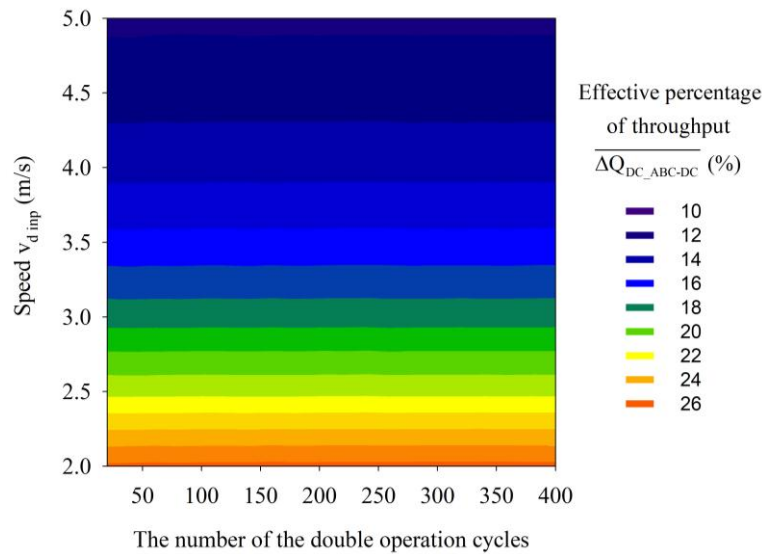

Figure 6.9: Average effective percentage of throughput in the time ABC zoning compared to one in the non-zoning when chaotic storage method is performed.

$v_{d,inp}$	2 m/s			3 m/s			4 m/s			5 m/s		
	\overline{E}_{DC} (kW/s/UL)	$\overline{E}_{DC,ABC}$ (kW/s/UL)	$\overline{\Delta E}_{DC,ABC-DC}$ (%)	\overline{E}_{DC} (kW/s/UL)	$\overline{E}_{DC,ABC}$ (kW/s/UL)	$\overline{\Delta E}_{DC,ABC-DC}$ (%)	\overline{E}_{DC} (kW/s/UL)	$\overline{E}_{DC,ABC}$ (kW/s/UL)	$\overline{\Delta E}_{DC,ABC-DC}$ (%)	\overline{E}_{DC} (kW/s/UL)	$\overline{E}_{DC,ABC}$ (kW/s/UL)	$\overline{\Delta E}_{DC,ABC-DC}$ (%)
20	20.3	10.6	-48.1	25.2	12.4	-50.9	28.9	13.5	-53.2	31.3	14.1	-55.1
40	20.3	10.5	-48.1	25.2	12.4	-50.8	28.9	13.5	-53.1	31.3	14.1	-55.0
60	20.3	10.6	-48.1	25.2	12.4	-50.8	28.9	13.5	-53.1	31.3	14.1	-55.1
80	20.3	10.6	-48.1	25.1	12.4	-50.8	28.9	13.5	-53.1	31.3	14.1	-55.1
100	20.3	10.6	-48.1	25.2	12.4	-50.8	28.9	13.5	-53.1	31.3	14.1	-55.1
160	20.3	10.6	-48.1	25.2	12.4	-50.9	28.9	13.5	-53.1	31.3	14.1	-55.0
200	20.3	10.5	-48.1	25.2	12.4	-50.8	28.9	13.5	-53.1	31.3	14.1	-55.0
260	20.3	10.5	-48.1	25.1	12.4	-50.8	28.9	13.5	-53.1	31.3	14.1	-55.0
300	20.3	10.5	-48.1	25.2	12.4	-50.8	28.9	13.5	-53.1	31.3	14.1	-55.1
360	20.3	10.5	-48.1	25.2	12.4	-50.8	28.9	13.5	-53.1	31.3	14.1	-55.0
400	20.3	10.5	-48.1	25.2	12.4	-50.8	28.9	13.5	-53.1	31.3	14.1	-55.0

Table 6.11: Comparison average energy need per unit load between the ABC zoning and the non-zoning when the chaotic storage method is performed.

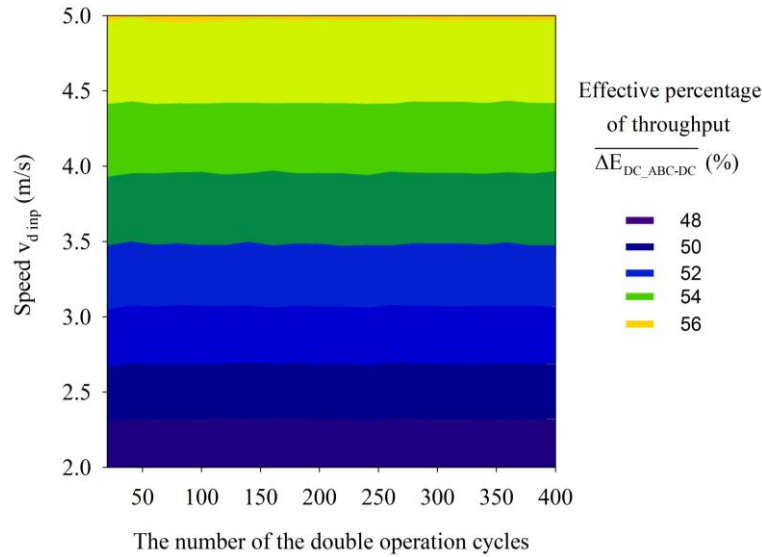

Figure 6.10: Average effective percentage of energy need per unit load in the time ABC zoning compared to one in the non-zoning when chaotic storage method is performed.

As a result, when the driving unit speed is higher, the average effective percentage of the throughput is lower and the average effective percentage of the energy need is higher and vice versa. The reason is that average moving distances of the driving unit in the time ABC zoning and the non-zoning are almost constant when the driving unit speed changes and the number of DOCs is constant. When the driving unit speed increases, the driving unit moves mainly in the distances for only the startup and braking phases of the time ABC zoning. Besides, the energy need and the driving time of the driving unit are constant in the distances for only the startup and braking phases when driving unit speed changes (Section 4.1.1). While the driving unit moves at high speed in the non-zoning, the energy need is

higher and the driving time is faster due to maximum speed is reached on many moving distances of the driving unit. It means that the average effective percentage of the throughput is lower and the average effective percentage of the energy need is higher when the driving unit speed increases.

The average effective percentages of the throughput per hour and the energy need per unit load of the ABC zoning compared to ones of the non-zoning in the chaotic storage method are determined and then the average effective percentage of the energy need per hour is shown by Table 6.12 and Fig. 6.11. The saving efficiency of the energy need is accordingly determined more specifically by the working time.

$v_{d\text{inp}}$	2 m/s			3 m/s			4 m/s			5 m/s		
	\overline{E}_{DC_h} (kWh/h)	$\overline{E}_{DC_{ABC_h}}$ (kWh/h)	$\overline{\Delta E}_{DC_{ABC-DC_h}}$ (%)	\overline{E}_{DC_h} (kWh/h)	$\overline{E}_{DC_{ABC_h}}$ (kWh/h)	$\overline{\Delta E}_{DC_{ABC-DC_h}}$ (%)	\overline{E}_{DC_h} (kWh/h)	$\overline{E}_{DC_{ABC_h}}$ (kWh/h)	$\overline{\Delta E}_{DC_{ABC-DC_h}}$ (%)	\overline{E}_{DC_h} (kWh/h)	$\overline{E}_{DC_{ABC_h}}$ (kWh/h)	$\overline{\Delta E}_{DC_{ABC-DC_h}}$ (%)
20	1.05	0.68	-35.04	1.45	0.84	-42.27	1.74	0.93	-46.75	1.93	0.97	-49.76
40	1.04	0.68	-35.04	1.45	0.84	-42.20	1.74	0.93	-46.69	1.92	0.97	-49.70
60	1.04	0.68	-35.03	1.45	0.84	-42.21	1.74	0.93	-46.69	1.93	0.97	-49.74
80	1.04	0.68	-34.99	1.45	0.84	-42.19	1.74	0.93	-46.67	1.93	0.97	-49.76
100	1.04	0.68	-35.00	1.45	0.84	-42.19	1.74	0.93	-46.66	1.93	0.97	-49.75
160	1.04	0.68	-35.03	1.45	0.84	-42.22	1.74	0.93	-46.64	1.92	0.97	-49.71
200	1.04	0.68	-35.02	1.45	0.84	-42.20	1.74	0.93	-46.68	1.92	0.97	-49.72
260	1.04	0.68	-35.01	1.44	0.84	-42.18	1.74	0.93	-46.66	1.92	0.97	-49.73
300	1.04	0.68	-35.02	1.45	0.84	-42.20	1.74	0.93	-46.68	1.93	0.97	-49.74
360	1.04	0.68	-35.01	1.45	0.84	-42.19	1.74	0.93	-46.67	1.92	0.97	-49.73
400	1.04	0.68	-35.01	1.45	0.84	-42.20	1.74	0.93	-46.65	1.92	0.97	-49.73

Table 6.12: Comparison average energy need per hour between the ABC zoning and the non-zoning when the chaotic storage method is performed.

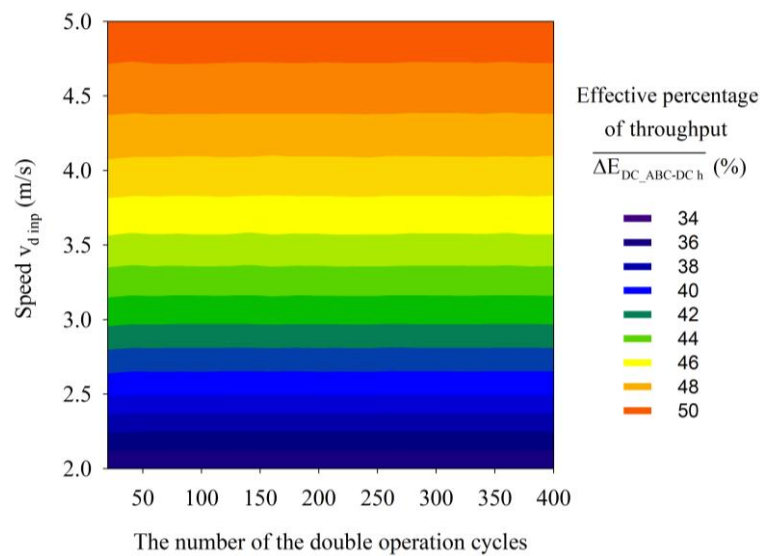

Figure 6.11: Average effective percentage of energy need per hour in the time ABC zoning compared to one in the non-zoning when chaotic storage method is performed.

6.2.3.2 Average effective percentages in the ABC zoning compared to the non-zoning when logical choice method is performed

When the logical choice method is performed in the time ABC zoning and the non-zoning, the average effective percentage $\overline{\Delta Q_{L_ABC-L}}$ of the throughput $\overline{Q_{LOG_ABCt}}$ of the time ABC zoning compared with the throughput $\overline{Q_{LOG}}$ of the non-zoning is shown by Table 6.13 and Figure 6.12 when the number of DOCs increases from 20 to 400 cycles and the driving unit speed increases from 2 m/s to 5 m/s. Besides, the average effective percentage $\overline{\Delta E_{L_ABC-L}}$ of the energy need $\overline{E_{LOG_ABCt}}$ of the time ABC zoning compared with the energy need $\overline{E_{LOG}}$ of the non-zoning is shown by Table 6.14 and Fig. 6.13.

$V_{d\ imp}$	2 m/s			3 m/s			4 m/s			5 m/s		
	$\overline{Q_{LOG}}$ (UL/h)	$\overline{Q_{LOG_ABCt}}$ (UL/h)	$\overline{\Delta Q_{L_ABC-L}}$ (%)	$\overline{Q_{LOG}}$ (UL/h)	$\overline{Q_{LOG_ABCt}}$ (UL/h)	$\overline{\Delta Q_{L_ABC-L}}$ (%)	$\overline{Q_{LOG}}$ (UL/h)	$\overline{Q_{LOG_ABCt}}$ (UL/h)	$\overline{\Delta Q_{L_ABC-L}}$ (%)	$\overline{Q_{LOG}}$ (UL/h)	$\overline{Q_{LOG_ABCt}}$ (UL/h)	$\overline{\Delta Q_{L_ABC-L}}$ (%)
20	197.6	235.5	19.2	217.2	246.3	13.4	226.1	249.8	10.5	230.1	250.9	9.1
40	198.9	236.1	18.7	218.3	246.8	13.1	227.2	250.3	10.2	231.3	251.5	8.7
60	199.3	236.3	18.5	218.7	247.0	13.0	227.6	250.6	10.1	231.7	251.7	8.6
80	199.6	236.4	18.4	219.0	247.2	12.9	228.0	250.8	10.0	232.0	251.9	8.6
100	199.8	236.5	18.4	219.1	247.3	12.8	228.2	250.8	9.9	232.2	252.0	8.5
160	200.0	236.7	18.3	219.5	247.5	12.7	228.5	251.0	9.9	232.6	252.2	8.4
200	200.2	236.8	18.3	219.6	247.5	12.7	228.6	251.1	9.8	232.8	252.3	8.4
260	200.3	236.8	18.3	219.7	247.6	12.7	228.8	251.2	9.8	232.9	252.3	8.3
300	200.3	236.9	18.3	219.8	247.6	12.7	228.8	251.2	9.8	233.0	252.4	8.3
360	200.4	236.9	18.2	219.9	247.7	12.7	228.9	251.3	9.8	233.0	252.4	8.3
400	200.4	236.9	18.2	219.9	247.7	12.7	228.9	251.3	9.8	233.1	252.4	8.3

Table 6.13: Comparison average throughput per hour between the ABC zoning and the non-zoning when the logical choice method is performed.

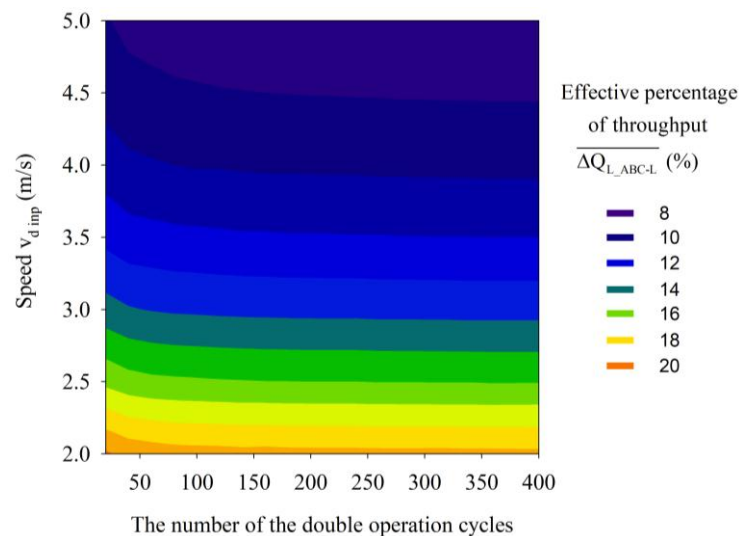

Figure 6.12: Average effective percentage of throughput in the time ABC zoning compared to one in the non-zoning when the logical choice method is performed.

The average effective percentage of the throughput $\overline{\Delta Q_{L_ABC-L}}$ of the time ABC zoning increases highly when the driving unit speed decreases, e.g. Fig 6.12, when the number of DOCs is 300 cycles, $\overline{\Delta Q_{L_ABC-L}}$ increases from 8.3 % at 5 m/s and up to 18.3% at 2 m/s. The average effective percentage of the throughput $\overline{\Delta Q_{L_ABC-L}}$ is almost unchanged when the driving unit speed is constant and the required number of DOCs changes.

$v_{d\,inp}$	2 m/s			3 m/s			4 m/s			5 m/s		
DOCs	$\overline{E_{LOG}}$ (kW/s/UL)	$\overline{E_{LOG\,ABC1}}$ (kW/s/UL)	$\overline{\Delta E_{L_ABC-L}}$ (%)	$\overline{E_{LOG}}$ (kW/s/UL)	$\overline{E_{LOG\,ABC1}}$ (kW/s/UL)	$\overline{\Delta E_{L_ABC-L}}$ (%)	$\overline{E_{LOG}}$ (kW/s/UL)	$\overline{E_{LOG\,ABC1}}$ (kW/s/UL)	$\overline{\Delta E_{L_ABC-L}}$ (%)	$\overline{E_{LOG}}$ (kW/s/UL)	$\overline{E_{LOG\,ABC1}}$ (kW/s/UL)	$\overline{\Delta E_{L_ABC-L}}$ (%)
20	17.2	9.7	-43.3	21.1	11.4	-46.0	24.1	12.5	-48.2	26.0	13.0	-50.1
40	16.8	9.6	-42.9	20.6	11.2	-45.6	23.6	12.3	-47.7	25.5	12.8	-49.6
60	16.7	9.5	-42.8	20.4	11.1	-45.5	23.4	12.2	-47.6	25.3	12.8	-49.6
80	16.6	9.5	-42.7	20.3	11.1	-45.3	23.2	12.2	-47.5	25.2	12.7	-49.5
100	16.5	9.5	-42.6	20.3	11.1	-45.3	23.1	12.2	-47.4	25.1	12.7	-49.5
160	16.4	9.4	-42.6	20.1	11.0	-45.2	23.0	12.1	-47.4	25.0	12.6	-49.4
200	16.4	9.4	-42.5	20.1	11.0	-45.2	23.0	12.1	-47.4	24.9	12.6	-49.4
260	16.3	9.4	-42.5	20.0	11.0	-45.1	22.9	12.1	-47.4	24.9	12.6	-49.4
300	16.3	9.4	-42.5	20.0	11.0	-45.1	22.9	12.1	-47.4	24.9	12.6	-49.4
360	16.3	9.4	-42.5	20.0	11.0	-45.1	22.9	12.1	-47.3	24.8	12.6	-49.4
400	16.3	9.4	-42.4	20.0	11.0	-45.1	22.9	12.1	-47.3	24.8	12.6	-49.4

Table 6.14: Comparison average energy need per unit load between the ABC zoning and the non-zoning when the logical choice method is performed.

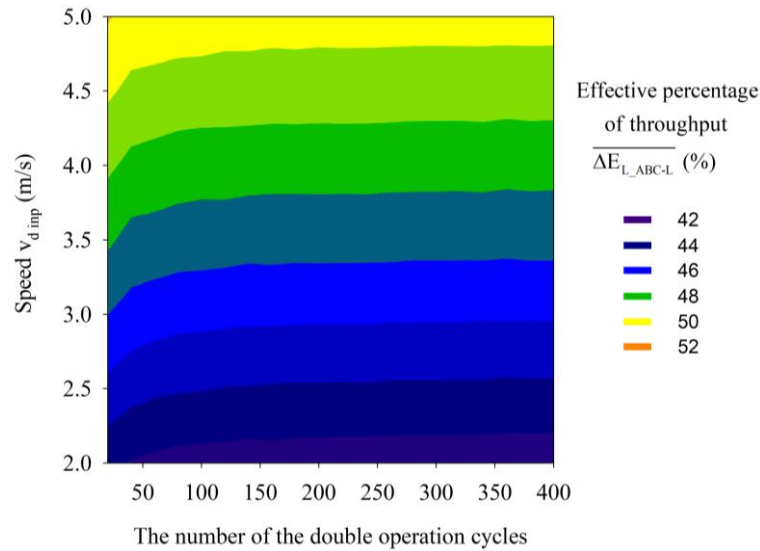

Figure 6.13: Average effective percentage of energy need per unit load in the time ABC zoning compared to one in the non-zoning when the logical choice method is performed.

The average effective percentage of the energy need $\overline{\Delta E_{L_ABC-L}}$ of the time ABC zoning in this case is quite high (about 42.5÷50%) when the driving unit speed increases from 2 m/s to 5 m/s. It is almost unchanged when the driving unit speed is constant and the required

number of DOCs changes ($\overline{\Delta Q_{L_ABC-L}}$ and $\overline{\Delta E_{L_ABC-L}}$ change a little more when the required number of DOCs is low). When the driving unit speed increases, the average effective percentages of the throughput and the energy need tend to change less.

As a result, when the driving unit speed is higher, the average effective percentage of the throughput is lower and the average effective percentage of the energy need is higher and vice versa. The reason is explained as the same as in Section 6.2.3.1.

After the average effective percentages of the throughput per hour and the energy need per unit load of the ABC zoning compared to ones of the non-zoning in the logical choice method are determined, the average effective percentage of the energy need per hour is shown by Table 6.15 and Fig. 6.14. The saving efficiency of the energy need is accordingly determined more specifically by the working time.

$v_{d\ imp}$	2 m/s			3 m/s			4 m/s			5 m/s		
	$\overline{E_{LOGh}}$ (kWh/h)	$\overline{E_{LOGABC h}}$ (kWh/h)	$\overline{\Delta E_{L_ABC-Lh}}$ (%)	$\overline{E_{LOGh}}$ (kWh/h)	$\overline{E_{LOGABC h}}$ (kWh/h)	$\overline{\Delta E_{L_ABC-Lh}}$ (%)	$\overline{E_{LOGh}}$ (kWh/h)	$\overline{E_{LOGABC h}}$ (kWh/h)	$\overline{\Delta E_{L_ABC-Lh}}$ (%)	$\overline{E_{LOGh}}$ (kWh/h)	$\overline{E_{LOGABC h}}$ (kWh/h)	$\overline{\Delta E_{L_ABC-Lh}}$ (%)
20	0.94	0.64	-32.43	1.27	0.78	-38.78	1.51	0.86	-42.74	1.66	0.91	-45.56
40	0.93	0.63	-32.26	1.25	0.77	-38.50	1.49	0.86	-42.41	1.64	0.90	-45.23
60	0.92	0.63	-32.17	1.24	0.76	-38.38	1.48	0.85	-42.33	1.63	0.89	-45.21
80	0.92	0.62	-32.10	1.24	0.76	-38.29	1.47	0.85	-42.26	1.62	0.89	-45.22
100	0.92	0.62	-32.07	1.23	0.76	-38.27	1.47	0.85	-42.20	1.62	0.89	-45.20
160	0.91	0.62	-32.07	1.23	0.76	-38.22	1.46	0.85	-42.18	1.61	0.89	-45.11
200	0.91	0.62	-32.02	1.22	0.76	-38.20	1.46	0.84	-42.21	1.61	0.88	-45.13
260	0.91	0.62	-31.99	1.22	0.76	-38.18	1.46	0.84	-42.20	1.61	0.88	-45.14
300	0.91	0.62	-31.99	1.22	0.76	-38.19	1.46	0.84	-42.21	1.61	0.88	-45.15
400	0.91	0.62	-31.95	1.22	0.75	-38.18	1.46	0.84	-42.18	1.61	0.88	-45.15

Table 6.15: Comparison average energy need per hour between the ABC zoning and the non-zoning when the logical choice method is performed.

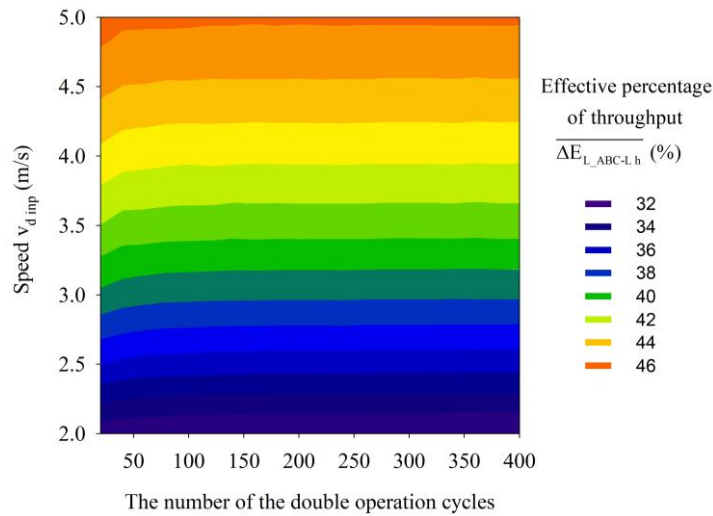

Figure 6.14: Average effective percentage of energy need per hour in the time ABC zoning compared to one in the non-zoning when the logical choice method is performed.

6.2.3.3 Average effective percentages of logical choice method in the ABC zoning compared to the ones of chaotic storage method in the non-zoning

When the logical choice method is performed in the time ABC zoning and the chaotic storage method is performed in the non-zoning of DOC, the average effective percentage $\overline{\Delta Q_{L_ABC-DC}}$ of the throughput $\overline{Q_{LOG_ABCt}}$ of the time ABC zoning compared with the throughput $\overline{Q_{DC}}$ of the non-zoning is shown by Table 6.16 and Figure 6.15 when the number of DOCs increases from 20 to 400 cycles and the driving unit speed increases from 2 m/s to 5 m/s. In addition, the average effective percentage $\overline{\Delta E_{L_ABC-DC}}$ of the energy need $\overline{E_{LOG_ABCt}}$ of the time ABC zoning compared with the energy need $\overline{E_{DC}}$ of the non-zoning is shown by Table 6.17 and Fig. 6.16.

v_{d_inp}	2 m/s			3 m/s			4 m/s			5 m/s		
	$\overline{Q_{DC}}$ (UL/h)	$\overline{Q_{LOG_ABCt}}$ (UL/h)	$\overline{\Delta Q_{L_ABC-DC}}$ (%)	$\overline{Q_{DC}}$ (UL/h)	$\overline{Q_{LOG_ABCt}}$ (UL/h)	$\overline{\Delta Q_{L_ABC-DC}}$ (%)	$\overline{Q_{DC}}$ (UL/h)	$\overline{Q_{LOG_ABCt}}$ (UL/h)	$\overline{\Delta Q_{L_ABC-DC}}$ (%)	$\overline{Q_{DC}}$ (UL/h)	$\overline{Q_{LOG_ABCt}}$ (UL/h)	$\overline{\Delta Q_{L_ABC-DC}}$ (%)
20	185.1	235.5	27.2	206.9	246.3	19.0	217.1	249.8	15.1	221.6	250.9	13.2
40	185.0	236.1	27.6	206.9	246.8	19.3	217.0	250.3	15.3	221.6	251.5	13.5
60	185.0	236.3	27.7	206.8	247.0	19.4	217.0	250.6	15.5	221.6	251.7	13.6
80	185.0	236.4	27.8	206.9	247.2	19.5	217.0	250.8	15.5	221.6	251.9	13.7
100	185.0	236.5	27.9	206.8	247.3	19.6	217.0	250.8	15.6	221.6	252.0	13.7
160	184.9	236.7	28.0	206.8	247.5	19.6	217.0	251.0	15.7	221.6	252.2	13.8
200	185.0	236.8	28.0	206.8	247.5	19.7	217.0	251.1	15.7	221.6	252.3	13.8
260	184.9	236.8	28.1	206.9	247.6	19.7	217.0	251.2	15.7	221.6	252.3	13.9
300	184.9	236.9	28.1	206.8	247.6	19.7	217.0	251.2	15.8	221.6	252.4	13.9
400	184.9	236.9	28.1	206.8	247.7	19.8	217.0	251.3	15.8	221.6	252.4	13.9

Table 6.16: Comparison average throughput per hour between chaotic storage method of the non-zoning and logical choice method of the ABC zoning.

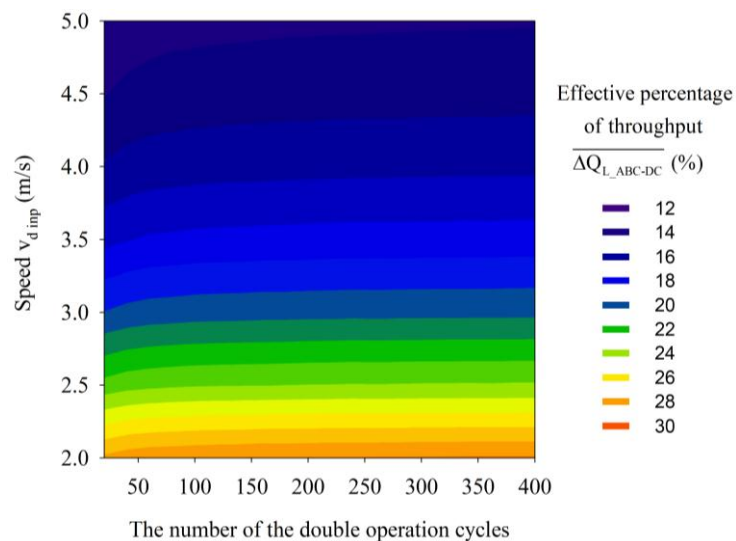

Figure 6.15: Average effective percentage of throughput of logical choice method in the ABC zoning compared to one of chaotic storage method in the non-zoning.

$V_{d\,inp}$	2 m/s			3 m/s			4 m/s			5 m/s		
	\overline{E}_{DC} (kW/s/UL)	$\overline{E}_{LOGABC1}$ (kW/s/UL)	$\overline{\Delta E}_{L_ABC-DC}$ (%)	\overline{E}_{DC} (kW/s/UL)	$\overline{E}_{LOGABC1}$ (kW/s/UL)	$\overline{\Delta E}_{L_ABC-DC}$ (%)	\overline{E}_{DC} (kW/s/UL)	$\overline{E}_{LOGABC1}$ (kW/s/UL)	$\overline{\Delta E}_{L_ABC-DC}$ (%)	\overline{E}_{DC} (kW/s/UL)	$\overline{E}_{LOGABC1}$ (kW/s/UL)	$\overline{\Delta E}_{L_ABC-DC}$ (%)
20	20.3	9.7	-52.1	25.2	11.4	-54.8	28.9	12.5	-56.8	31.3	13.0	-58.5
40	20.3	9.6	-52.8	25.2	11.2	-55.4	28.9	12.3	-57.4	31.3	12.8	-59.0
60	20.3	9.5	-53.1	25.2	11.1	-55.7	28.9	12.2	-57.6	31.3	12.8	-59.2
80	20.3	9.5	-53.3	25.1	11.1	-55.9	28.9	12.2	-57.8	31.3	12.7	-59.4
100	20.3	9.5	-53.4	25.2	11.1	-56.0	28.9	12.2	-57.8	31.3	12.7	-59.5
160	20.3	9.4	-53.7	25.2	11.0	-56.2	28.9	12.1	-58.0	31.3	12.6	-59.6
200	20.3	9.4	-53.8	25.2	11.0	-56.3	28.9	12.1	-58.1	31.3	12.6	-59.7
260	20.3	9.4	-53.8	25.1	11.0	-56.3	28.9	12.1	-58.1	31.3	12.6	-59.7
300	20.3	9.4	-53.9	25.2	11.0	-56.4	28.9	12.1	-58.2	31.3	12.6	-59.8
360	20.3	9.4	-54.0	25.2	11.0	-56.4	28.9	12.1	-58.2	31.3	12.6	-59.8
400	20.3	9.4	-54.0	25.2	11.0	-56.4	28.9	12.1	-58.2	31.3	12.6	-59.8

Table 6.17: Comparison average energy need per unit load between chaotic storage method of the non-zoning and logical choice method of the ABC zoning.

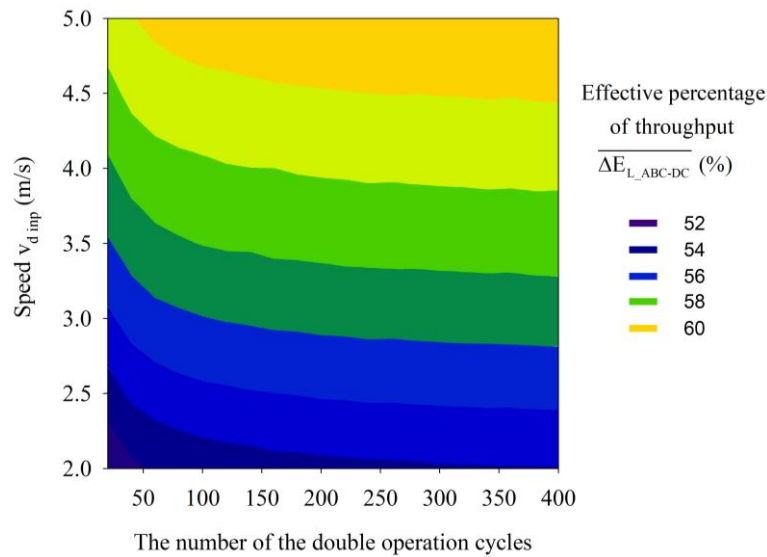

Figure 6.16: Average effective percentage of energy need of logical choice method in the ABC zoning compared to one of chaotic storage method in the non-zoning.

The average effective percentage of the throughput $\overline{\Delta Q}_{L_ABC-DC}$ increases quite highly when the driving unit speed decreases, e.g. Fig 6.15, when the number of DOCs is 300 cycles, $\overline{\Delta Q}_{L_ABC-DC}$ increases from 13.9 % at 5 m/s and up to 28.1% at 2 m/s. The average effective percentage of the throughput $\overline{\Delta Q}_{L_ABC-DC}$ is almost unchanged when the driving unit speed is constant and the required number of DOCs changes. The average effective percentage of the energy need $\overline{\Delta E}_{L_ABC-DC}$ is very high (about 52-60%) when the driving unit speed increases from 2 m/s to 5 m/s. It is almost unchanged when the driving unit speed is

constant and the required number of DOCs changes. Only if the required number of DOCs is low, does $\overline{\Delta E_{L_ABC-L}}$ decrease about 2%. When the driving unit speed increases, the average effective percentages of the throughput and the energy need tend to change less.

To sum up, when the driving unit speed is higher, the average effective percentage of the throughput of the logical choice method in the time ABC zoning compared with the throughput of the chaotic storage method in the non-zoning is lower and the average effective percentage of the energy need is higher and vice versa. The reason is explained as the same as in Section 6.2.3.1.

$V_{d\,inp}$	2 m/s			3 m/s			4 m/s			5 m/s		
DOCs	$\overline{E_{DC\,h}}$ (kWh/h)	$\overline{E_{LOG\,ABC\,h}}$ (kWh/h)	$\overline{\Delta E_{L_ABC-DC\,h}}$ (%)	$\overline{E_{DC\,h}}$ (kWh/h)	$\overline{E_{LOG\,ABC\,h}}$ (kWh/h)	$\overline{\Delta E_{L_ABC-DC\,h}}$ (%)	$\overline{E_{DC\,h}}$ (kWh/h)	$\overline{E_{LOG\,ABC\,h}}$ (kWh/h)	$\overline{\Delta E_{L_ABC-DC\,h}}$ (%)	$\overline{E_{DC\,h}}$ (kWh/h)	$\overline{E_{LOG\,ABC\,h}}$ (kWh/h)	$\overline{\Delta E_{L_ABC-DC\,h}}$ (%)
20	1.05	0.64	-39.07	1.45	0.78	-46.22	1.74	0.86	-50.32	1.93	0.91	-53.00
40	1.04	0.63	-39.79	1.45	0.77	-46.81	1.74	0.86	-50.83	1.92	0.90	-53.43
60	1.04	0.63	-40.12	1.45	0.76	-47.10	1.74	0.85	-51.06	1.93	0.89	-53.69
80	1.04	0.62	-40.29	1.45	0.76	-47.25	1.74	0.85	-51.19	1.93	0.89	-53.83
100	1.04	0.62	-40.45	1.45	0.76	-47.36	1.74	0.85	-51.27	1.93	0.89	-53.90
160	1.04	0.62	-40.72	1.45	0.76	-47.57	1.74	0.85	-51.42	1.92	0.89	-54.01
200	1.04	0.62	-40.81	1.45	0.76	-47.65	1.74	0.84	-51.52	1.92	0.88	-54.07
260	1.04	0.62	-40.90	1.44	0.76	-47.70	1.74	0.84	-51.56	1.92	0.88	-54.13
300	1.04	0.62	-40.96	1.45	0.76	-47.75	1.74	0.84	-51.61	1.93	0.88	-54.17
360	1.04	0.62	-41.01	1.45	0.75	-47.79	1.74	0.84	-51.63	1.92	0.88	-54.20
400	1.04	0.62	-41.03	1.45	0.75	-47.82	1.74	0.84	-51.63	1.92	0.88	-54.21

Table 6.18: Comparison average energy need per hour between chaotic storage method of the non-zoning and logical choice method of the ABC zoning.

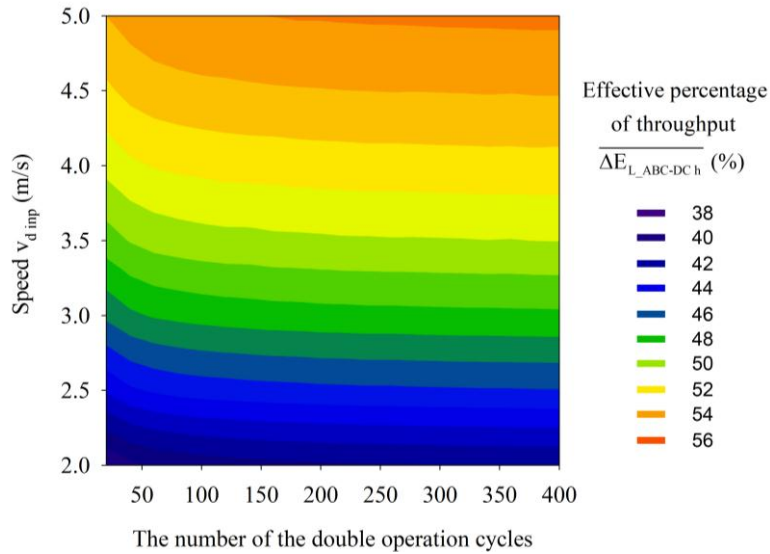

Figure 6.17: Average effective percentage of energy need per hour of logical choice method in ABC zoning compared to one of chaotic storage method in non-zoning.

The average effective percentages of the throughput per hour and the energy need per unit load of the logical choice method in the ABC zoning compared to ones of the chaotic storage method in the non-zoning are determined and then the average effective percentage of the energy need per hour is shown by Table 6.18 and Fig. 6.17. The saving efficiency of the energy need is accordingly determined more specifically by the working time.

6.2.3.4 Average effective percentages of chaotic storage method in the ABC zoning compared to the ones of logical choice method in the non-zoning

The chaotic storage method is performed in the time ABC zoning and the logical choice method is performed in the non-zoning of DOC. The average effective percentage $\overline{\Delta Q_{DC_ABC-L}}$ of the throughput $\overline{Q_{DC_ABC-t}}$ of the time ABC zoning compared with the throughput $\overline{Q_{LOG}}$ of the non-zoning is accordingly shown by Table 6.19 and Figure 6.18 when the number of DOCs increases from 20 to 400 cycles and the driving unit speed increases from 2 m/s to 5 m/s. The average effective percentage $\overline{\Delta E_{DC_ABC-L}}$ of the energy need $\overline{E_{DC_ABC-t}}$ of the time ABC zoning compared with the energy need $\overline{E_{LOG}}$ of the non-zoning is shown by Table 6.20 and Fig. 6.19 as well.

The average effective percentage of the throughput $\overline{\Delta Q_{DC_ABC-L}}$ increases highly when v_{dinp} decreases and the number of DOCs is constant, e.g. Fig 6.18, when the number of DOCs is 200 cycles, $\overline{\Delta Q_{DC_ABC-L}}$ increases from 6.5% at 5 m/s and up to 15.7% at 2 m/s. The average effective percentage of the throughput $\overline{\Delta Q_{DC_ABC-L}}$ is almost unchanged when the driving unit speed is constant and the required number of DOCs changes ($\overline{\Delta Q_{DC_ABC-L}}$ only increases about 1.5% when the required number of DOCs is low).

v_{dinp}	2 m/s			3 m/s			4 m/s			5 m/s		
DOCs	$\overline{Q_{LOG}}$ (UL/h)	$\overline{Q_{DC_ABC-t}}$ (UL/h)	$\overline{\Delta Q_{DC_ABC-L}}$ (%)	$\overline{Q_{LOG}}$ (UL/h)	$\overline{Q_{DC_ABC-t}}$ (UL/h)	$\overline{\Delta Q_{DC_ABC-L}}$ (%)	$\overline{Q_{LOG}}$ (UL/h)	$\overline{Q_{DC_ABC-t}}$ (UL/h)	$\overline{\Delta Q_{DC_ABC-L}}$ (%)	$\overline{Q_{LOG}}$ (UL/h)	$\overline{Q_{DC_ABC-t}}$ (UL/h)	$\overline{\Delta Q_{DC_ABC-L}}$ (%)
20	197.6	231.6	17.2	217.2	243.2	12.0	226.1	246.7	9.1	230.1	247.8	7.7
40	198.9	231.7	16.5	218.3	243.1	11.4	227.2	246.7	8.6	231.3	247.8	7.1
60	199.3	231.7	16.2	218.7	243.1	11.2	227.6	246.7	8.4	231.7	247.8	6.9
80	199.6	231.6	16.0	219.0	243.1	11.0	228.0	246.7	8.2	232.0	247.8	6.8
100	199.8	231.7	15.9	219.1	243.1	10.9	228.2	246.7	8.1	232.2	247.8	6.7
160	200.0	231.6	15.8	219.5	243.1	10.8	228.5	246.7	8.0	232.6	247.8	6.5
200	200.2	231.7	15.7	219.6	243.1	10.7	228.6	246.7	7.9	232.8	247.8	6.5
260	200.3	231.7	15.7	219.7	243.1	10.6	228.8	246.7	7.8	232.9	247.8	6.4
300	200.3	231.7	15.6	219.8	243.1	10.6	228.8	246.7	7.8	233.0	247.8	6.4
400	200.4	231.7	15.6	219.9	243.1	10.6	228.9	246.7	7.8	233.1	247.8	6.3

Table 6.19: Comparison average throughput per hour between logical choice method of the non-zoning and chaotic storage method of the ABC zoning.

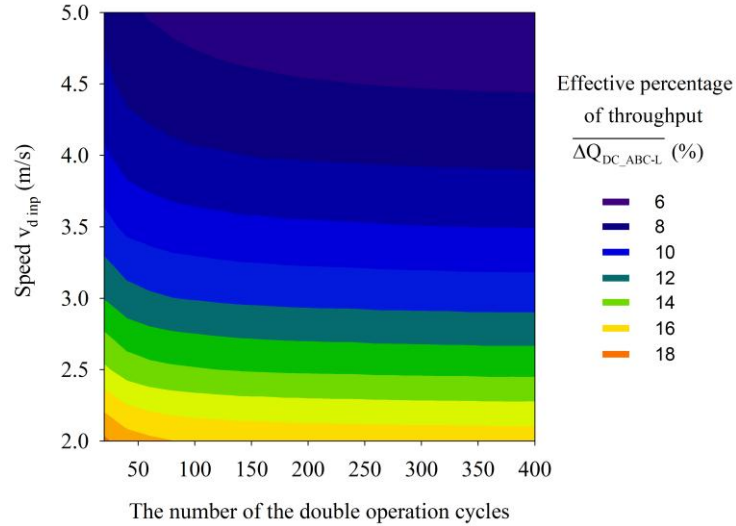

Figure 6.18: Average effective percentage of throughput of chaotic storage method in the ABC zoning compared to one of logical choice method in the non-zoning.

The average effective percentage of the energy need $\overline{\Delta E_{DC_ABC-L}}$ is high (about 35÷46%) when the driving unit speed increases from 2 m/s to 5 m/s. When the required number of DOCs is big and the driving unit speed is constant, the average effective percentage of the energy need is almost unchanged. When the required number of DOCs is small and the driving unit speed is constant, the average effective percentage of the energy need drops about 3%. When the driving unit speed increases, the average effective percentages of the throughput and the energy need tend to change less.

Therefore, when the driving unit speed is higher, the average effective percentage of the throughput of the chaotic storage method in the time ABC zoning compared with the throughput of the logical choice method in the non-zoning is lower and the average effective percentage of the energy need is higher and vice versa. The reason is explained as the same as Section 6.2.3.1.

v_{dimp}	2 m/s			3 m/s			4 m/s			5 m/s		
DOCs	$\overline{E_{LOG}}$ (kW/s/UL)	$\overline{E_{DC_ABC-L}}$ (kW/s/UL)	$\overline{\Delta E_{DC_ABC-L}}$ (%)	$\overline{E_{LOG}}$ (kW/s/UL)	$\overline{E_{DC_ABC-L}}$ (kW/s/UL)	$\overline{\Delta E_{DC_ABC-L}}$ (%)	$\overline{E_{LOG}}$ (kW/s/UL)	$\overline{E_{DC_ABC-L}}$ (kW/s/UL)	$\overline{\Delta E_{DC_ABC-L}}$ (%)	$\overline{E_{LOG}}$ (kW/s/UL)	$\overline{E_{DC_ABC-L}}$ (kW/s/UL)	$\overline{\Delta E_{DC_ABC-L}}$ (%)
20	17.2	10.6	-38.6	21.1	12.4	-41.3	24.1	13.5	-43.8	26.0	14.1	-46.0
40	16.8	10.5	-37.3	20.6	12.4	-40.0	23.6	13.5	-42.5	25.5	14.1	-44.8
60	16.7	10.6	-36.7	20.4	12.4	-39.4	23.4	13.5	-42.0	25.3	14.1	-44.4
80	16.6	10.6	-36.3	20.3	12.4	-39.1	23.2	13.5	-41.7	25.2	14.1	-44.2
100	16.5	10.6	-36.0	20.3	12.4	-38.9	23.1	13.5	-41.5	25.1	14.1	-44.0
200	16.4	10.5	-35.5	20.1	12.4	-38.4	23.0	13.5	-41.1	24.9	14.1	-43.6
260	16.3	10.5	-35.4	20.0	12.4	-38.2	22.9	13.5	-41.0	24.9	14.1	-43.5
300	16.3	10.5	-35.3	20.0	12.4	-38.2	22.9	13.5	-40.9	24.9	14.1	-43.4
400	16.3	10.5	-35.1	20.0	12.4	-38.1	22.9	13.5	-40.8	24.8	14.1	-43.4

Table 6.20: Comparison average energy need per unit load between logical choice method of the non-zoning and chaotic storage method of the ABC zoning.

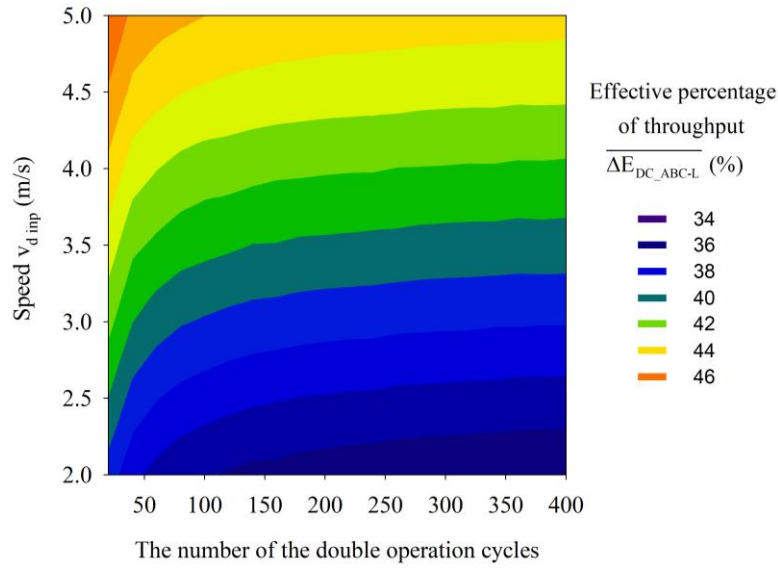

Figure 6.19: Average effective percentage of energy need per unit load of chaotic storage method in the ABC zoning compared to one of logical choice method in the non-zoning.

After the average effective percentages of the throughput per hour and the energy need per unit load of the chaotic storage method in the ABC zoning compared to ones of the logical choice method in the non-zoning are determined, the average effective percentage of the energy need per hour is shown by Table 6.21 and Fig. 6.20. The saving efficiency of the energy need is accordingly determined more specifically by the working time.

$v_{d\text{inp}}$	2 m/s			3 m/s			4 m/s			5 m/s		
	\overline{E}_{LOGh} (kWh/h)	\overline{E}_{DCABC} (kWh/h)	$\overline{\Delta E}_{DC_ABC-Lh}$ (%)	\overline{E}_{LOGh} (kWh/h)	\overline{E}_{DCABC} (kWh/h)	$\overline{\Delta E}_{DC_ABC-Lh}$ (%)	\overline{E}_{LOGh} (kWh/h)	\overline{E}_{DCABC} (kWh/h)	$\overline{\Delta E}_{DC_ABC-Lh}$ (%)	\overline{E}_{LOGh} (kWh/h)	\overline{E}_{DCABC} (kWh/h)	$\overline{\Delta E}_{DC_ABC-Lh}$ (%)
20	0.94	0.68	-27.96	1.27	0.84	-34.29	1.51	0.93	-38.62	1.66	0.97	-41.81
40	0.93	0.68	-26.91	1.25	0.84	-33.17	1.49	0.93	-37.56	1.64	0.97	-40.84
60	0.92	0.68	-26.41	1.24	0.84	-32.69	1.48	0.93	-37.18	1.63	0.97	-40.55
80	0.92	0.68	-26.07	1.24	0.84	-32.37	1.47	0.93	-36.90	1.62	0.97	-40.40
100	0.92	0.68	-25.86	1.23	0.84	-32.21	1.47	0.93	-36.74	1.62	0.97	-40.26
160	0.91	0.68	-25.54	1.23	0.84	-31.91	1.46	0.93	-36.50	1.61	0.97	-39.98
200	0.91	0.68	-25.37	1.22	0.84	-31.78	1.46	0.93	-36.45	1.61	0.97	-39.93
260	0.91	0.68	-25.22	1.22	0.84	-31.65	1.46	0.93	-36.35	1.61	0.97	-39.87
300	0.91	0.68	-25.15	1.22	0.84	-31.61	1.46	0.93	-36.33	1.61	0.97	-39.84
360	0.91	0.68	-25.06	1.22	0.84	-31.55	1.46	0.93	-36.25	1.61	0.97	-39.80
400	0.91	0.68	-25.00	1.22	0.84	-31.53	1.46	0.93	-36.23	1.61	0.97	-39.77

Table 6.21: Comparison average energy need per hour between logical choice method of the non-zoning and chaotic storage method of the ABC zoning.

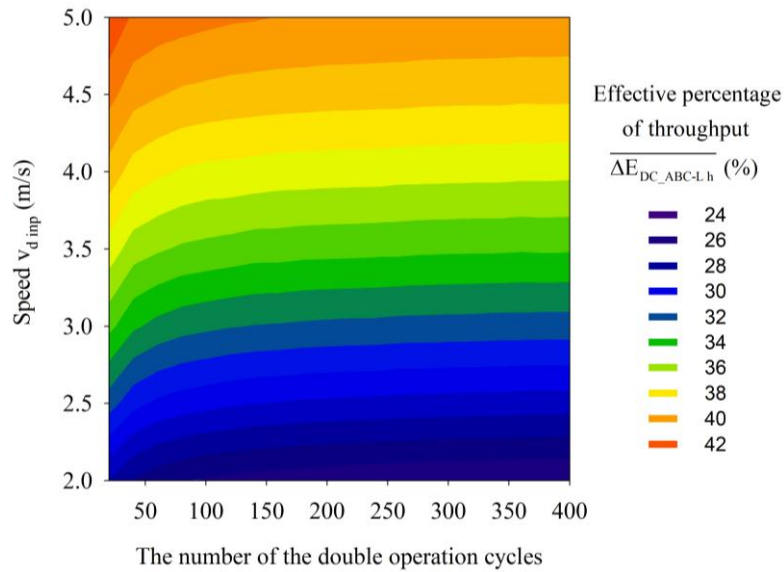

Figure 6.20: Average effective percentage of energy need per hour of chaotic storage method in ABC zoning compared to one of logical choice method in non-zoning.

6.2.4 Summary the efficiencies of the storage methods in double operation cycle

The average effective percentages of the throughput and the energy need of the storage methods in the double operation cycle are shown from Section 6.2.1 to 6.2.3 when the number of DOCs increases from 20 to 400 cycles and the driving unit speed increases from 2 m/s to 5 m/s. They are briefly illustrated by Figure 6.21 to point out the most general view of the storage methods in DOC.

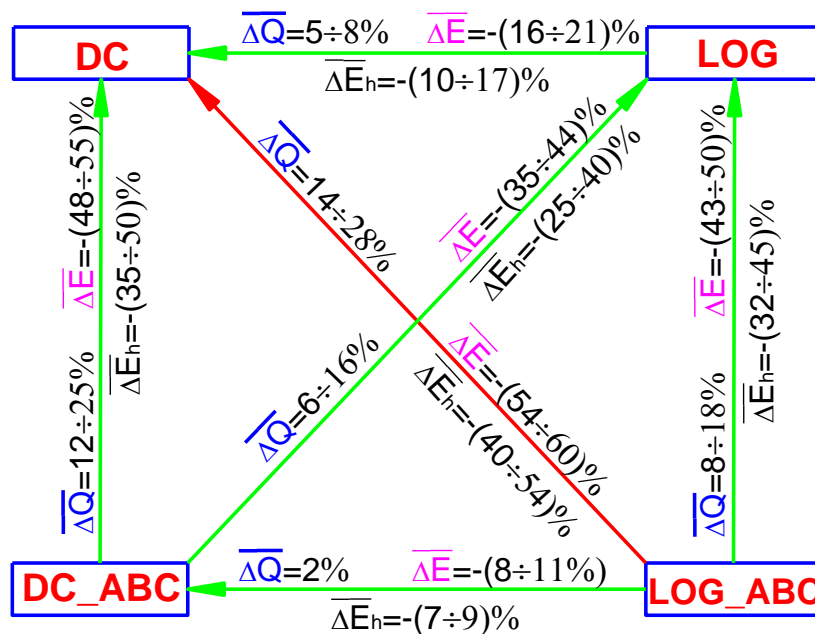

Figure 6.21: Relationship of average effective percentages of throughput and energy need of the storage methods in DOC.

1 → **2**: Comparison of average effective percentages of case 1 to case 2

DC: the chaotic storage method applied in the non-zoning.

DC_ABC: the chaotic storage method applied in the time ABC zoning.

LOG: the logical choice method applied in the non-zoning.

LOG_ABC: the logical choice method applied in the time ABC zoning.

$\overline{\Delta Q}$: average effective percentage of the throughput between two methods.

$\overline{\Delta E}$: average effective percentage of the energy need per unit load between two methods.

$\overline{\Delta E_h}$: average effective percentage of the energy need per hour between two methods.

From the relationship of average effective percentages of the throughput and the energy need, some remarks are indicated when storage methods are implemented as follows:

- When the storage methods are compared to each other, the average effective percentage of the throughput is always much smaller than the one of the energy need.
- Among the storage methods of DOC, the efficiencies of the throughput and the energy need of the chaotic storage method in the non-zoning are the lowest. This storage method is usually applied in the simple warehouses and the throughput of the goods is low.
- The efficiencies of the throughput and the energy need of the ABC zoning are much higher than the ones of the non-zoning, which do not depend on applying the logical choice method or the chaotic storage method. It means that to achieve the high efficiencies of the throughput and the energy need, the first important factor is to choose the ABC zoning of the system and then the logical choice method is applied in the ABC zoning.
- When the system is divided by the ABC zoning, the average effective percentage of throughput of the logical choice method compared to the one of the chaotic storage method is small about 2%. Therefore, the main advantage of the logical choice method in the ABC zoning is the energy need.
- The efficiencies of the throughput and the energy need of the logical choice method in the ABC zoning are the highest among the storage methods of DOC. The average effective percentage of the throughput of the logical choice method in the ABC zoning compared to the one of the chaotic storage method in the non-zoning is about 14-28%. Besides, the average effective percentage of the energy need per unit load is very high about 54-60%.
- Due to the development of the information technology, it is easy to determine the required storage and retrieval positions and to choose the pairs of the storage and retrieval positions in the system. Therefore, the logical choice method in the ABC zoning should be applied in the automatic storage and retrieval system by the above highlight advantages.

6.2.5 Influence of the driving unit speed and the required number of the double operation cycles to throughput and energy need for the logical choice method

As the advantages of the logical choice method, it can be put into practical applications depending on the throughput and the required number of DOCs. To operate the system by the logical choice method when the system is the non-zoning, the relationship of average throughput per hour or average energy need per unit load with variation of the driving unit speeds and the required number of DOCs is established by Fig. 6.22 and Fig. 6.23. Besides, when the system is divided by the time ABC zoning, the relationship of average throughput per hour or average energy need per unit load with variation of the driving unit speeds and the required number of DOCs is established by Fig. 6.24 and Fig. 6.25.

The system is divided by the time ABC zoning or the non-zoning when the driving unit speed is constant and the required number of DOCs is smaller than 40 cycles and then the average throughput and the average energy need change a little bit shown from Fig. 6.22 to Fig. 6.25. The required number of DOCs is bigger than 40 cycles and then the average throughput and the average energy need are nearly constant when the driving unit speed is constant. It means that when the logical choice method is applied, the required number of DOCs in one implementation does not need much due to the efficiencies of the throughput and the energy need are nearly constant.

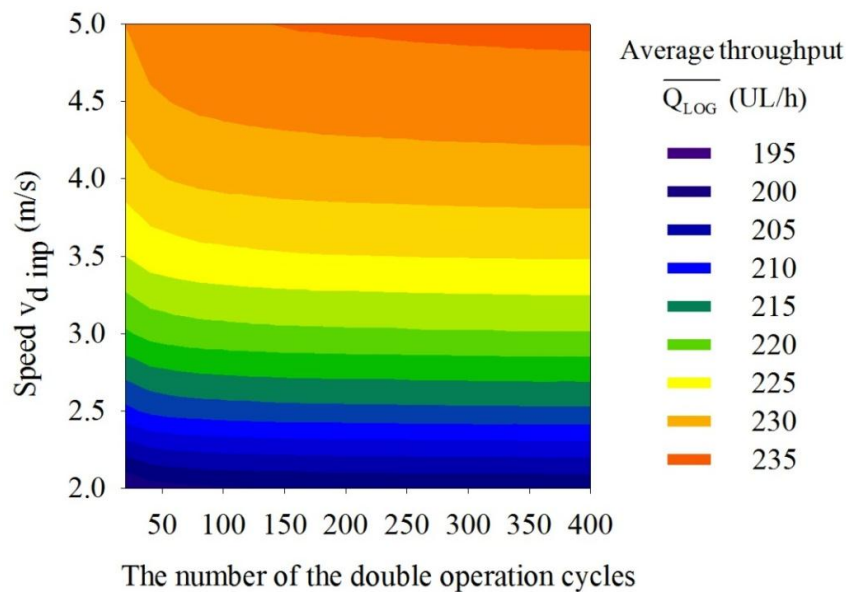

Figure 6.22: Average throughput per hour of logical choice method with variation of driving unit speeds and required number of DOCs, transferring point X00Y02 and $v_{imp} = 4\text{m/s}$, $a_{imp} = 4\text{m/s}^2$ when the system is the non-zoning.

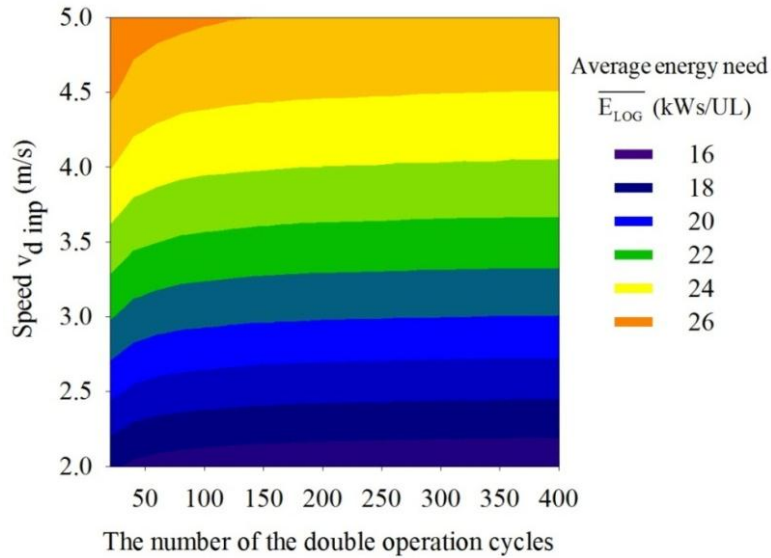

Figure 6.23: Average energy need per unit load of logical choice method with variation of driving unit speeds and required number of DOCs, transferring point X00Y02 and $v_{imp} = 4\text{m/s}$, $a_{imp} = 4\text{m/s}^2$ when the system is the non-zoning.

When the system is the non-zoning and the driving unit speed increases from 2 to 5 m/s, the average throughput and the average energy need of the logical choice method increase highly. However, the average energy need increases much more highly than the average throughput, e.g. the required number of DOCs is 100 cycles and the speed increases from 2 to 5 m/s then the average throughput increases 16.2% and average energy need increases 52.1%. Therefore, the logical speed of the driving unit is chosen to minimize energy consumption by the practical requirements.

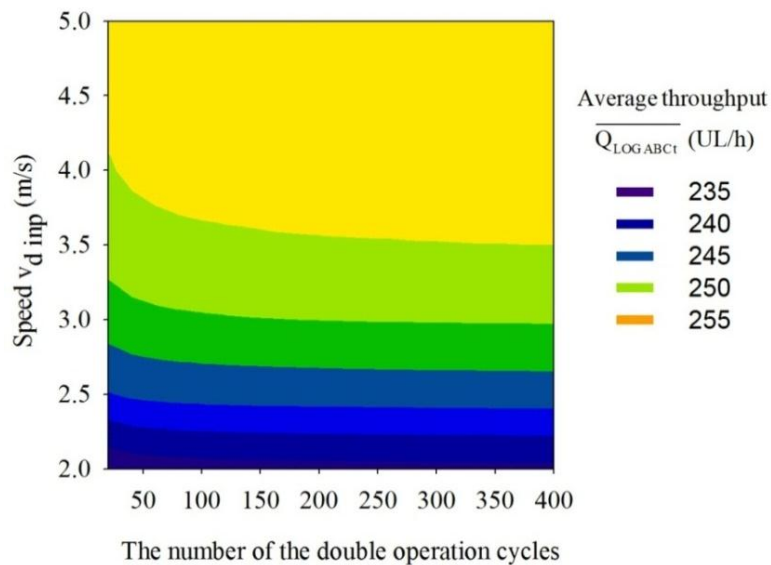

Figure 6.24: Average throughput per hour of logical choice method with variation of driving unit speeds and required number of DOCs in the time ABC zoning, transferring point X00Y02 and $v_{imp} = 4\text{m/s}$, $a_{imp} = 4\text{m/s}^2$.

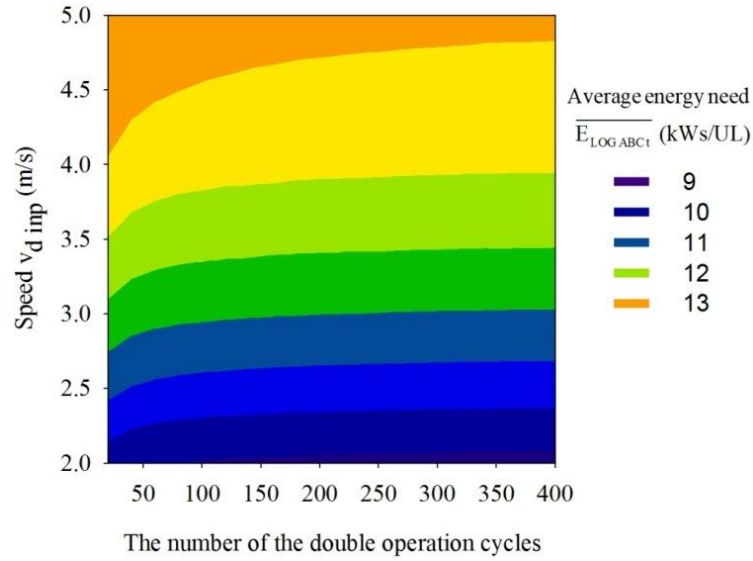

Figure 6.25: Average energy need per unit load of logical choice method with variation of driving unit speeds and required number of DOCs in the time ABC zoning, transferring point X00Y02 and $v_{\text{imp}} = 4 \text{ m/s}$, $a_{\text{imp}} = 4 \text{ m/s}^2$.

When the system is divided by the time ABC zoning and the driving unit speed increases from 2 m/s to 5 m/s, the average throughput of the logical choice method does not rise highly but the average energy need increases quite highly, e.g. the required number of DOCs is 100 cycles and the speed increases from 2 m/s to 5 m/s then the average throughput increases 6.5% and average energy need increases 33.9%. Therefore, in the time ABC zoning, the low speed should be applied to operate the system and then the throughput changes slightly and the energy efficiency is high.

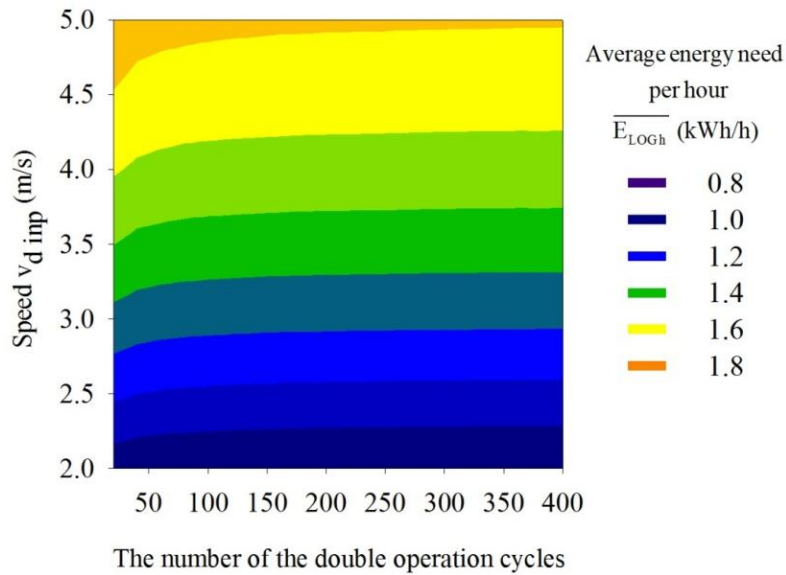

Figure 6.26: Average energy need per hour of logical choice method with variation of driving unit speeds and required number of DOCs, transferring point X00Y02 and $v_{\text{imp}} = 4 \text{ m/s}$, $a_{\text{imp}} = 4 \text{ m/s}^2$ when the system is the non-zoning.

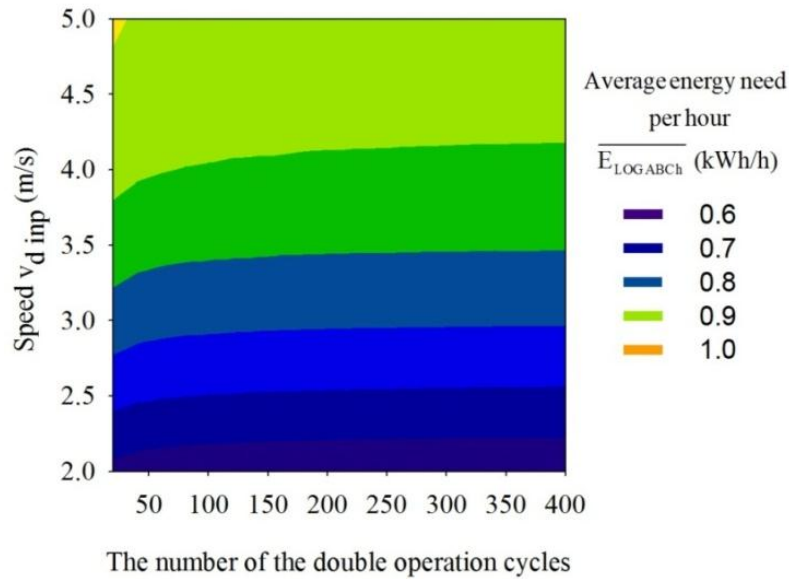

Figure 6.27: Average energy need per hour of logical choice method with variation of driving unit speeds and required number of DOCs in the time ABC zoning, transferring point X00Y02 and $v_{imp} = 4\text{ m/s}$, $a_{imp} = 4\text{ m/s}^2$.

When the driving unit speed increases highly, the throughput and energy need tend to change less. In particular, when the system is divided by the time ABC zoning, the throughput and energy need change insignificantly at high speed, e.g. the required number of DOCs is 200 cycles and the driving unit speed increases from 4 m/s to 5 m/s then the average throughput increases 0.5% and average energy need increases 4.1%. The reason is that when the driving unit speed increases highly, the distances for only the startup and braking phases of the time ABC zoning increase very fast and then the driving unit moves mainly in these distances. It means that the throughput and energy need change a little bit.

The average throughput per hour and the average energy need per unit load of the logical choice method are determined and then the average energy need per hour in the non-zoning is shown by Fig. 6.26. The average energy need per hour in the time ABC zoning is shown by Fig. 6.27. As a result, the energy consumption of the system is determined more specifically by the working time.

Chapter 7

Conclusion and outlook

7.1 Conclusion

The present thesis reports about the methods to improve the throughput and the energy need in the movement strategies of SRV. The advantages and disadvantages of existing warehouse operation strategies are indicated. As a result, the new methods to increase the productivity and reduce the energy need of SRV are investigated. The models are established to simulate the parameters of SRV similar to the experimental model. The new methods are shown by the data of the simulation models respectively.

The simulation model of SOC is established from the theory and the coefficients of the experimental results. It simulates the kinematic parameters, the power and the energy consumption of SRV by the time. This model can be applied in various storage and retrieval systems with different coefficients K_i and K_f (Section 3.1.2). From the simulation model, the positions of the compartments are determined, that SRV only moves in the startup and braking phases or full phases, when the kinematic parameters change. When the input acceleration is constant and the input speed increases, the driving unit moves in the longer startup and braking distance. When the input acceleration increases and the input speed is constant, the driving unit moves in the shorter startup and braking distance. When the driving unit moves on the distances for only the startup and braking phases, the input speed is constant and the input acceleration increases and then the moving time of SRV decreases and the energy need increases. However, when the input

speed changes and the input acceleration is constant, the moving time and the energy need of the driving unit are constant (it is different with the long distance). When SRV moves on the long distances, the moving time of increasing the input speed decreases faster than the one of increasing the input acceleration. When the lifting unit moves on the distances for only the startup and braking phases, the lifting time is determined as the moving time of the driving unit and the energy need of the lifting unit is constant with every input speed and acceleration.

From the data of the simulation model, the energy need of all compartments is determined by the time, the acceleration and the speed. Based on the figures of these relationships, the best energy need of SRV is shown by the required time in each compartment. Due to the required moving time of the driving unit, the acceleration increases and then the energy need decreases. The shorter the distance of the driving unit is, the better efficiency to save energy by selecting the appropriate acceleration is. On the given distance, the input acceleration is fixed and the input speed increases to a certain value and then the moving time and the energy need of the driving unit are unchangeable. Besides, the energy need of the driving unit reduces in both cases: firstly, when the input acceleration decreases and the input speed is fixed; secondly, when the input acceleration increases and the moving time is fixed. The energy need of the lifting unit does not depend on the kinematic parameters. The lifting time is chosen to suit the moving time so that all lifting unit and driving unit simultaneously arrive at the destination to reduce the machine parts' wear and to achieve the best energy efficiency by the required throughput of SRV.

The simulation model of DOC developed from the simulation model of SOC is established. From the theoretical formulas to determine the average values when the system is divided by the time ABC zoning or the non-zoning and the results received from the simulation models of SOC and DOC, the average values of the throughput and the energy need in the operation cycles are determined. When the speed increases, the average throughput per hour and the average energy need per unit load also increase in all cases. However, the average energy need increases significantly compared to the average throughput.

The efficient percentages of the average energy need of the ABC zoning compared to the non-zoning are high in both movement strategies of SOC and DOC. These efficiencies increase more about 6-7% when the speed increases from 2 m/s to 5 m/s. Besides, the efficient percentages of the average throughput of the ABC zoning compared to the non-zoning deduct about 13-15% in both movement strategies. In particular, the efficient percentages of the average energy need and the average throughput of DOC in the ABC zoning compared to SOC of the non-zoning are very high (when the speed increases from 2 m/s to 5 m/s, the energy efficiency increases from 65% to 69.8% and the throughput efficiency decreases from 53.7% to 29.9%). When the speed increases from 2 m/s to 5 m/s in non-zoning and in the ABC zoning, the efficient percentages of the average energy need

of DOC compared to SOC change slightly about 1-2% and the efficient percentage of the average throughput decreases significantly (5-7%).

SOC and DOC can be combined in the operating processes to achieve the high efficiencies of the throughput and the energy need. From average moving time and the average energy need per unit load of SOC and DOC, the specific values of the average throughput and the average energy need of each storage combination are determined by the movement percentage of DOC and the required speed of the driving unit. Based on the required throughput and the required movement percentage of DOC in reality, the required speed of driving unit are determined to achieve the best energy efficiency. When the required throughput is constant and the movement percentage of DOC increases, the driving unit speed and the energy need decrease. When the driving unit speed is constant and the movement percentage of DOC increases, the throughput increases and the energy need decreases. When the movement percentage of DOC is constant and the driving unit speed increases, the throughput and the energy need of the system increase. The movement percentage of DOC should be chosen as large as possible to achieve the best energy efficiency by the required throughput.

The energy need and the moving time of SRV in DOC in some specific cases are compared to the ones in SOC. And then, when a storage position and a retrieval position are chosen in a pair of DOC: *The farther from the I/O point a storage position and a retrieval position are and the nearer to each other by horizontal direction they are, the higher the saving efficiencies of the energy need and the moving time in DOC are.* These values are much higher than their average values. Besides, when SRV moves firstly to one of any two defined positions, the saving efficiencies of the total moving time in DOC are the same and the saving efficiencies of the total energy need change a little bit during all the ways of DOC. When the storage position and the retrieval position are far from each other mainly by vertical direction, the saving efficiency of the energy need in DOC changes a little bit and the saving efficiency of the moving time is equal or also changes a little bit (the smaller the driving unit speed is, the less the change of the saving efficiency is).

The logical choice among the storage and retrieval positions in DOC is aimed at reducing the energy need and the moving time of SRV. The general method of the logical choice among the storage and retrieval positions of DOC is developed by directly comparing the pairs of DOC in order to analyze the flexible pairs of DOC. The general case to choose two pairs of DOC from any four positions to get the best efficiencies of the energy need and the moving time is shown: *The farthest storage position is chosen in a pair with the farthest retrieval position and the remaining storage position is chosen in a pair with the remaining retrieval position.*

The method to choose the pairs of DOC is extended to the entire system to keep the best efficiencies of the energy need and the moving time based on the inductive approach: *The*

farthest storage compartment and the farthest retrieval compartment by horizontal direction are always selected as the first pair and then the second pair is selected at the second farthest storage and retrieval compartments and so on. Finally, the storage and retrieval compartments at the nearest positions to I/O point by horizontal direction are chosen". The system gets the best efficiencies of the energy need and the moving time in DOC respectively. This method is only applied when the kinematic parameters of the lifting unit are big and the maximum lifting height is just average. Besides, the system has to an energy recovery system. If the system is high and then the energy efficiency of this method is still suitable due to the energy recovery rate of the lifting unit is about 70% the lifting unit energy consumption on every height. However, the lifting time is quite big and it directly affects to the total working time then the saving efficiency of the moving time is not high.

The logical choice method of the pairs of DOC in the entire system is compared with the chaotic storage method when the system is divided by the time ABC zoning, the energy ABC zoning or the non-zoning to prove its advantages (Chapter 6). Firstly, when the system is non-zoning: if the number of DOCs increases and the driving unit speed is constant and then the average effective percentage of the throughput of the logical choice method only changes slightly and the average effective percentage of the energy need increases; if the number of DOCs is constant and the speed increases and then the average effective percentage of the throughput drops fast and the average effective percentage of the energy need changes a little bit and it is quite high. As a result, when the required number of DOCs is small and the speed is high and then the main advantage of the logical choice method is the energy need. Secondly, when the logical choice method is applied in the time ABC zoning: the average effective percentage of the throughput is not high and increases a little bit when the speed reduces and the number of DOCs increases. Besides, the average effective percentage of the energy need is high at every speed and it increases when the number of DOCs increases. Finally, when the logical choice method is applied in the energy ABC zoning, the average throughput and the average energy need of the time ABC zoning are compared to the average throughput and the average energy need of the energy ABC zoning to determine which division is better: the efficiencies of the average throughput and the average energy need of the energy ABC zoning are a little bit lower than the ones of the time ABC zoning. As a result, the time ABC zoning is used for calculating the average throughput and the average energy need of the logical choice method in DOC. From the results of the effective percentages in the time ABC zoning and the non-zoning, the effective percentages of the average throughput and the average energy need of the logical choice method compared with the chaotic storage method increase when the system is long.

When the storage methods in DOC are compared to each other, the average effective percentage of the throughput is always much smaller than the one of the energy need. Besides, the efficiencies of the throughput and the energy need of the chaotic storage method in the non-zoning are the lowest. The efficiencies of the throughput and the energy need of the ABC zoning are much higher than the ones of the non-zoning, which do not depend on applying the logical choice method or the chaotic storage method. When the system is divided by the ABC zoning, the main advantage of the logical choice method is the energy need. In the storage methods of DOC, the efficiencies of the throughput and the energy need of the logical choice method in the ABC zoning are the highest.

As the advantages of the logical choice method, it can be put into practical applications depending on the throughput and the required number of DOCs. The storage and retrieval system is divided by the time ABC zoning or the non-zoning, when the driving unit speed is constant and the required number of DOCs is smaller than 40 cycles and then the average throughput and average energy need change a little bit. The required number of DOCs is bigger than 40 cycles and then the average throughput and average energy need are nearly constant when the driving unit speed is constant. When the system is the non-zoning and the driving unit speed increases, the average throughput and the average energy need of the logical choice method increase highly. However, the average energy need increases much more highly than the average throughput. Therefore, the logical speed of the driving unit is chosen to minimize energy consumption by the practical requirements. When the system is divided by the time ABC zoning and the driving unit speed increases, the average throughput of the logical choice method does not rise highly but the average energy need increases quite highly. Therefore, in the time ABC zoning, the low speed should be applied to operate the system and then the throughput changes slightly and the energy efficiency is high.

7.2 Outlook

The studies in this thesis can be extended further investigations in the future by various aspects as described in the following:

If the system is high and then the energy efficiency of the logical choice method among the storage and retrieval positions in DOC is still suitable due to the energy recovery rate of the lifting unit is about 70% the energy consumption of the lifting unit on every height. However, the lifting time is quite big and it directly affects to the total working time of SRV then the saving efficiency of the moving time is not high. In this case, depending on the height of the system, it is possible to divide the system into zones of height and this method is applied in each zone. After that, the saving efficiencies of the energy need and the moving time can be still suitable.

The coefficients K_d and K_l of the driving unit and the lifting unit should be determined by the real systems to further test the rightness of the simulation model and the choice methods.

When the system is high, the time ABC zoning and the energy ABC zoning change and then the energy ABC zoning can be more effective than the time ABC zoning when the logical choice method among the storage and retrieval positions in DOC is applied.

Another consideration, the driving unit speed in the different zones (Zone A, B and C) of the ABC zoning is adjusted to suit to each zone. Due to Zone A is the nearest and Zone C is the farthest then the system can achieve the high efficiencies of the energy need and the throughput in both SOC and DOC when the driving unit speed in Zone A is adjusted to decrease and in Zone C is adjusted to increase.

To determine the logical storage and retrieval method of SRV in SOC and DOC, the average storage time of each individual goods needs to be considered to have the appropriate warehouse operation strategies and then the efficiencies of the throughput and the energy need of SRV can increase.

The previous studies just mentioned to the same number of the storage units and the retrieval units at I/O point, thus the throughput efficiency did not affect the storage operation strategies. The throughput may depend on the filling rate of the goods and different levels of the storage and retrieval goods. The speed of the units can be always adjusted to change the throughput requirement depending on the degree of filling goods and then the warehouse operation strategies can be adapted to the different working speeds.

The speed and the acceleration of the units are only considered at the smallest level of 1 and the maximum level is 5. Depending on the required number of the storage and retrieval goods, these parameters can be adjusted differently to achieve the high efficiencies of the energy need by the required throughput.

The machine parts' wear should be considered in the future due to when the logical choice method among the storage and retrieval positions in DOC is executed, the kinematic parameters of the lifting unit always are maximum values (the energy need of the lifting unit does not depend on the kinematic parameters) and then the machine part can easily be worn. It will affect the maintenance and repair costs. Besides, the experimental coefficients are also changed to suit reality.

The strategies to reduce the energy need and increase the throughput of SRVs with multiple aisles, multiple load handling devices or multi-depth storages can be analyzed. After that, general storage and retrieval methods of the warehouse operation strategies can be determined to achieve the high efficiencies of the throughput and the energy need.

The efficiencies of the saving energy and the throughput of the system can increase when the locations of the input point and the output point are different, e.g. the input point is put

at a side and the output point is put at opposite side of the rack. And then, the different warehouse operation strategies can be adapted. Therefore, the impact of multiple transfer points on the throughput and the energy need of the systems should be analyzed.

The loading capacity in the simulation model is too small compared to the total mass of SRV. Therefore, the loading capacity has a negligible effect on the energy need of the driving unit. The simulation model should be extended with the bigger loading capacities and then the loading capacity directly affects the energy need of SRV. A new energy ABC zoning may be introduced respectively.

References

- [1] European Commission (2011): Communication from the commission to the European parliament, the council, the European economic and social committee and the committee of the regions - Energy Efficiency Plan 2011. Brussels.
- [2] Schulz, R. (2014): Untersuchung und Ableitung geeigneter Lagerbetriebsstrategien zur Verringerung des Energiebedarfs von Regalbediengeräten [PhD thesis]. Otto-von-Guericke-Universität Magdeburg, Magdeburg.
- [3] Schulz, R.; Monecke, J.; Zadek, H. (2012): Der Einfluss kinematischer Parameter auf den Energiebedarf eines Regalbediengerätes. In: Zadek, H. (editor): 8. Fachkolloquium der Wissenschaftlichen Gesellschaft für Technische Logistik e. V., Otto-von-Guericke-Universität Magdeburg, Magdeburg. pp. 70-79.
- [4] Donald F. Wood: Logistics business [Internet].
<https://www.britannica.com/topic/logistics-business>. Last update: 18/01/2018.
- [5] Tseng, Y.; Yue, W.L.; Taylor, M.A.P. (2005): The role of transportation in logistics chain. In: the Eastern Asia Society for Transportation studies 5, pp. 1657–1672.
- [6] Fusko, M.; Rakyta, M.; Manlig, F. (2017): Reducing of Intralogistics Costs of Spare Parts and Material of Implementation Digitization in Maintenance. *Procedia Engineering* 192, pp. 213–218.
- [7] Gudehus, T. (2010): *Logistik: Grundlagen - Strategien - Anwendungen*. Springer, Heidelberg Germany.
- [8] Logistics journal: Definition Intralogistics [Internet].
<https://www.logistics-journal.de/about/intralogistics>. Last update: 16.11.2017.
- [9] Invata Intralogistics: Intralogistics: A Definition [Internet].
<http://www.invata.com/we-are-invata/the-art-of-intralogistics>.
Last update: 13.11.2017.
- [10] Arnold, D. (2006): *Intralogistik: Potentiale, Perspektiven, Prognosen*. Springer, Berlin.
- [11] Altintas, O.; Avsar, C.; Klumpp, M. (2010): Change to Green in Intralogistics. In: *The 2010 European: Simulation and Modelling Conference*. Hasselt University, Oostende (ETI), pp. 373-377.
- [12] Günthner, W.A.; Heptner, K. (2007): *Technische Innovationen für die Logistik*. Huss, München.

- [13] Lambert, D.M.; Stock, J.R. (1993): Strategic logistics management (Irwin series in marketing). Irwin, Homewood.
- [14] Rushton, A.; Oxley, J. (1989): Handbook of logistics and distribution management. Kogan Page Ltd, London.
- [15] Arnold, D.; Lsermann, H.; Kuhn, A.; Tempelmeier, H.; Furmans, K. (2008): Handbuch logistik. Springer, Berlin.
- [16] Bowersox, D.J.; Closs, D.J.; Helferich, O.K. (1986): Logistical management: A system integration of physical distribution, manufacturing support, and materials procurement. Macmillan, New York; Collier Macmillan, London.
- [17] Günthner, W.A.; Atz, T.; Ulbrich, A. (2011): Forschungsbericht zum Projekt integrierte lagersystemplanung. Technische Universität München.
- [18] VDI 2690 (1990): Material- und Datenfluss im Bereich von automatisierten Hochregallagern - Grundlagen. Verein Deutscher Ingenieure, Beuth Berlin.
- [19] FEM 9.851 (2003): Performance Data of S/R Machines Cycle Times. Federation Europeenne De La Manutention, Frankfurt.
- [20] FEM 9.101 (2016): Guideline / Terminology - Storage and Retrieval Machines - Definitions. European Materials Handling Federation, Frankfurt.
- [21] Hompel, M.; Sadowsky, V.; Beck, M. (2011): Kommissionierung: Materialflusssysteme 2 - Planung und Berechnung der Kommissionierung in der Logistik. (VDI-Buch), Springer, Berlin.
- [22] Hompel, M.; Schmidt, T. (2010): Warehouse Management: Organisation und Steuerung von Lager- und Kommissioniersystemen. (VDI-Buch), Springer, Berlin.
- [23] Hompel, M.; Schmidt, T.; Nagel, L. (2007): Materialflusssysteme: Förder- und Lagertechnik. (VDI-Buch), Springer, Berlin.
- [24] Hompel, M.; Heidenblut, V. (2011): Taschenlexikon Logistik: Abkürzungen, Definitionen und Erläuterungen der wichtigsten Begriffe aus Materialfluss und Logistik. (VDI-Buch), Springer, Berlin.
- [25] Seemüller, S. (2005): Durchsatzberechnung automatischer Kleinteilelager im Umfeld des elektronischen Handels [PhD thesis]. TU München, München Germany.
- [26] FEM 9.881 (2000): Project planning data for selected of drives for storage and retrieval machines. Federation Europeenne De La Manutention, Frankfurt.
- [27] Yadav, V.K.; Bhardwaj, N. (2013): Regenerative braking for an electric vehicle using hybrid energy storage system. Electrical and Electronics Engineering Research 3, pp. 35-42.
- [28] Jarushi, A.M.; Schofield, N. (2010): Battery and supercapacitor combination for a series hybrid electric vehicle. In: 5th IET International Conference on Power Electronics, Machines and Drives (PEMD 2010). Brighton, UK, pp. 151-156.

- [29] Schumann, M. (2008): Zur Bestimmung der Umschlagleistung von Hochregallagern unter besonderer Berücksichtigung der Lagerorganisation [PhD thesis]. TU Chemnitz, Chemnitz, Germany.
- [30] Graves, S.C.; Hausman, W.H.; Schwarz, L.B. (1997): Storage-Retrieval Interleaving in Automatic Warehousing Systems. *Management Science* 23, pp. 935-945.
- [31] Lee, H.F.; Schaefer, S.K. (1997): Sequencing methods for automated storage and retrieval systems with dedicated storage. *Computers & Industrial Engineering* 32, pp. 351-362.
- [32] Eben-Chaime, M. (1992): Operations sequencing in automated warehousing systems. *International Journal of Production Research* 30, pp. 2401-2409.
- [33] Chen, L.; Langevin, A.; Riopel, D. (2010): The storage location assignment and interleaving problem in an automated storage/retrieval system with shared storage. *International Journal of Production Research* 48, pp. 991-1011.
- [34] Tanaka, S.; Araki, M. (2009): Routing problem under the shared storage policy for unit-load automated storage and retrieval systems with separate input and output points. *International Journal of Production Research* 47, pp. 2391-2408.
- [35] van den Berg, J.P.; Gademann, A.J.R.M. (1999): Optimal routing in an automated storage/retrieval system with dedicated storage. *IIE Transactions* 31, pp. 407-415.
- [36] Malmberg, C.J.; Altassan, K.M. (1998): Analysis of storage assignment policies in less than unit load warehousing systems. *International Journal of Production Research* 36, pp. 3459-3475.
- [37] Fukunari, M.; Malmberg, C.J. (2008): A heuristic travel time model for random storage systems using closest open location load dispatching. *International Journal of Production Research* 46, pp. 2215-2228.
- [38] van den Berg, J.P.; Gademann, A.J.R.M. (2000): Simulation study of an automated storage/retrieval system. *International Journal of Production Research* 38, pp. 1339-1356.
- [39] Bozer, Y.A.; White, J.A. (1984): Travel-Time Models for Automated Storage/Retrieval Systems. *IIE Transactions* 16, pp. 329-338.
- [40] Randhawa, S.U.; McDowell, E.D.; Wang, W. (1991): Evaluation of scheduling rules for single- and dual-dock automated storage/retrieval system. *Computers & Industrial Engineering* 20, pp. 401-410.
- [41] van den Berg, J.P. (2002): Analytic expressions for the optimal dwell point in an automated storage/retrieval system. *International Journal of Production Economics* 76, pp. 13-25.

- [42] Wen, U.P.; Chang, D.T.; Chen, S.P. (2001): The impact of acceleration/deceleration on travel-time models in class-based automated S/R systems. *IIE Transactions* 33, pp. 599-608.
- [43] Atz, T.; Lantschner, D.; Günthner, W.A. (2013): Simulative throughput calculation for storage planning. In: *The International Workshop on Applied Modeling and Simulation*. Aix Marseilles University, pp. 88-97.
- [44] Ghomri, L.; Sari, Z. (2017): Mathematical modeling of the average retrieval time for flow-rack automated storage and retrieval systems. *Journal of Manufacturing Systems* 44, pp. 165-178.
- [45] Ghomri, L.; Sari, Z. (2015): Mathematical modeling of retrieval travel time for flow-rack automated storage and retrieval systems. *IFAC-Papers OnLine* 48, pp. 1906-1911.
- [46] Sarker, B.R.; Babu, P.S. (1995): Travel time models in automated storage/retrieval systems: A critical review. *International Journal of Production Economics* 40, pp. 173-184.
- [47] Hu, Y.; Huang, S.Y.; Chen, C.; Hsu, W.; Toh, A.C.; Loh, C.K.; Song, T. (2005): Travel time analysis of a new automated storage and retrieval system. *Computers & Operations Research* 32, pp. 1515-1544.
- [48] Lerher, T.; Sraml, M.; Potrc, I.; Tollazzi, T. (2010): Travel time models for double-deep automated storage and retrieval systems. *International Journal of Production Research* 48, pp. 3151-3172.
- [49] Lerher, T.; Potrč, I.; Šraml, M.; Tollazzi, T. (2010): Travel time models for automated warehouses with aisle transferring storage and retrieval machine. *European Journal of Operational Research* 205, pp. 571-583.
- [50] Hamzaoui, M.A.; Sari, Z. (2015): Optimal dimensions minimizing expected travel time of a single machine flow rack AS/RS. *Mechatronics* 31, pp. 158-168.
- [51] Eben-Chaime, M.; Pliskin, N. (1997): Operations management of multiple machine automatic warehousing systems. *International Journal of Production Economics* 51, pp. 83-98.
- [52] Gagliardi, J.; Renaud, J.; Ruiz, A. (2014): A simulation modeling framework for multiple-aisle automated storage and retrieval systems. *J Intell Manuf* 25, pp. 193-207.
- [53] Gagliardi, J.; Renaud, J.; Ruiz, A. (2015): Sequencing approaches for multiple-aisle automated storage and retrieval systems. *International Journal of Production Research* 53, pp. 5873-5883.

- [54] Hachemi, K.; Sari, Z.; Ghouali, N. (2012): A step-by-step dual cycle sequencing method for unit-load automated storage and retrieval systems. *Computers & Industrial Engineering* 63, pp. 980-984.
- [55] Roodbergen, K.J.; Vis, I.F.A. (2009): A survey of literature on automated storage and retrieval systems. *European Journal of Operational Research* 194, pp. 343-362.
- [56] Die Bundesregierung (2002): Perspektiven für Deutschland - Unsere Strategie für eine nachhaltige Entwicklung. Berlin, Germany.
- [57] Die Bundesregierung (2012): Nationale Nachhaltigkeitsstrategie - Fortschrittsbericht 2012. Berlin, Germany.
- [58] Die Bundesregierung (2016): Deutsche Nachhaltigkeitsstrategie - Neuauflage 2016. Berlin, Germany.
- [59] European Commission: 2030 Energy Strategy [Internet].
<https://ec.europa.eu/energy/en/topics/energy-strategy-and-energy-union/2030-energy-strategy>. Last update: 21/11/2017.
- [60] European Commission: Energy trends [Internet].
http://ec.europa.eu/eurostat/statistics-explained/index.php/Energy_trends.
 Last update: 21/11/2017.
- [61] Weisbrod, G.; Consulting, H.B.; Polenske, K.; Lynch, T.; Lin, X. (1995): The economic impact of energy efficiency - Programs and renewable power for Iowa. Boston University, Boston.
- [62] Müller, E.; Engelmann, J.; Löffler, T.; Strauch, J. (2013): *Energieeffiziente Fabriken planen und betreiben*. Springer, Berlin.
- [63] Bamberg, B.; Johann, A.; Waldow, P. (2012): Energy efficiency in logistics - SmartKanban as an intelligent intra-logistics architecture for Kanban scenarios. *it - Information Technology* 54, pp. 34-41.
- [64] Mahapatra, K.; Alm, R.; Hallgren, R.; Bischoff, L.; Tuglu, N.; Kuai, L.; Yang, Y.; Umoru, I. (2017): A behavioral change-based approach to energy efficiency in a manufacturing plant. *Energy Efficiency* 15.
- [65] Swantusch, R. (2011): Die schwarze Null bleibt Illusion. In: *Verkehrsrundschau*. Heinrich Vogel, München, pp. 42-43.
- [66] Müller, E.; Hopf, H.; Krones, M. (2013): Analyzing energy consumption for factory and logistics planning processes. In: *Advances in production management systems: Competitive manufacturing for innovative products and services*. IFIP WG 5.7 international conference, APMS 2012 Rhodes, Greece, pp. 49-56.
- [67] Bortolini, M.; Faccio, M.; Ferrari, E.; Gamberi, M.; Pilati, F. (2016): Time and energy optimal unit-load assignment for automatic S/R warehouses. *International Journal of Production Economics* 190, pp. 133-145.

- [68] Siegel, A.; Schulz, R.; Turek, K.; Schmidt, T.; Zadek, H. (2013): Modellierung des Energiebedarfs von Regalbediengeräten und verschiedener Lagerbetriebsstrategien zur Reduzierung des Energiebedarfs. In: 9. Fachkolloquium Logistik der Wissenschaftlichen Gesellschaft für Technische Logistik. TU Dortmund, Dortmund, pp. 91-108.
- [69] Meneghetti, A.; Monti, L. (2013): How energy recovery can reshape storage assignment in automated warehouse. In: Advances in production management systems: Competitive manufacturing for innovative products and services. IFIP WG 5.7 international conference, APMS 2012 Rhodes, Greece, pp. 33-40.
- [70] Arnold, D.; Furmans, K. (2009): Materialfluss in Logistiksystemen. Springer, Berlin.
- [71] Schulz, R.; Monecke, J.; Zadek, H. (2012): Isoenergetic Shelves of Automatic Small Parts Warehouses. Logistics journal.
- [72] Günther, H.; Tempelmeier, H. (2012): Produktion und Logistik. Springer, Berlin.
- [73] Cao, T.D.; Zadek, H. (2017): Controlling storage vehicle in distances for only the startup, braking phases and optimizing the energy need. In: 10th International Doctoral Students Workshop on Logistics. Otto-von-Guericke-Universität Magdeburg, Magdeburg, pp. 39-44.
- [74] Assmann, B.; Selke, P. (2011): Technische Mechanik 3. Oldenbourg Wissenschaftsverlag, München.
- [75] Schröder, T. (2007): Entwicklung und Evaluation von Algorithmen zur zeitoptimierten Bewegungszerlegung bei kinematisch redundanten Werkzeugmaschinen [PhD thesis]. TU Chemnitz, Chemnitz, Germany.
- [76] Weck, M.; Brecher, C. (2006): Werkzeugmaschinen 4 - Automatisierung von Maschinen und Anlagen. (VDI-Buch), Springer, Berlin.
- [77] Scheffler, M. (1994): Grundlagen der Fördertechnik - Elemente und Triebwerke: Mit 457 Abbildungen und 73 Tabellen. Vieweg, Braunschweig, Germany.
- [78] Rajamani, R. (2012): Vehicle Dynamics and Control. Springer, Boston: USA.
- [79] Cao, T.D.; Zadek, H. (2018): Logical choice method among positions in double operation cycle of the storage vehicle. In: 11th International Doctoral Students Workshop on Logistics. Otto-von-Guericke-Universität Magdeburg, Magdeburg, pp. 85-90.

Appendix A: Positions to experiment and primary data from the experimental results

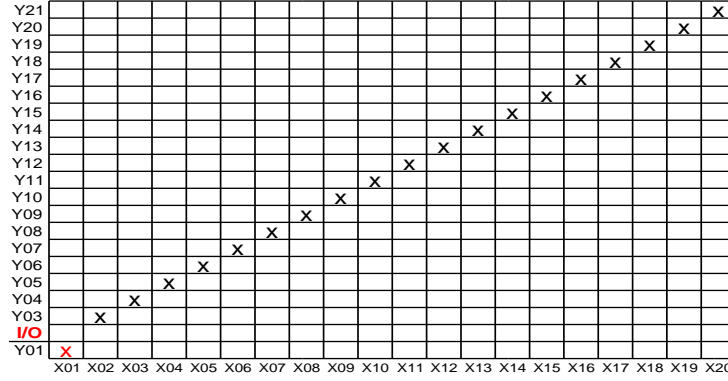

Figure A.1: Positions to experiment in the storage and retrieval system.

	SRV' position	Driving unit			Lifting unit	
		$t_{d\text{ Exper}}$ (s)	$E_{dp\text{ Exper}}$ (kW)	$E_{dn\text{ Exper}}$ (kW)	$E_{lp\text{ Exper}}$ (kW)	$E_{ln\text{ Exper}}$ (kW)
1	X00Y02 to X20Y21	11.10	8.97	-0.63	13.83	
2	X20Y21 to X00Y02	11.14	9.15	-0.60		-9.92
3	X00Y02 to X20Y21	11.12	8.75	-0.64	13.53	
4	X20Y21 to X01Y01	10.60	8.62	-0.61		-10.10
5	X01Y01 to X20Y21	10.60	8.29	-0.59	14.20	
6	X20Y21 to X01Y01	10.58	8.62	-0.58		-10.20
7	X01Y01 to X19Y20	10.10	8.03	-0.64	13.31	
8	X19Y20 to X01Y01	10.10	8.11	-0.64		-9.75
9	X01Y01 to X17Y18	9.10	6.91	-0.62	11.99	
10	X17Y18 to X01Y01	9.12	7.19	-0.58		-8.82
11	X01Y01 to X15Y16	8.12	6.29	-0.59	10.60	
12	X15Y16 to X01Y01	8.08	6.51	-0.64		-7.50
13	X01Y01 to X13Y14	7.10	5.41	-0.64	8.95	
14	X13Y14 to X01Y01	7.06	5.51	-0.61		-6.58
15	X01Y01 to X11Y12	6.12	4.55	-0.62	7.59	
16	X11Y12 to X01Y01	6.06	4.71	-0.59		-5.55
17	X01Y01 to X09Y10	5.08	3.78	-0.63	6.20	
18	X09Y10 to X01Y01	5.08	3.91	-0.60		-4.53
19	X01Y01 to X07Y08	4.06	3.01	-0.67	4.88	
20	X07Y08 to X01Y01	4.10	3.02	-0.59		-3.65
21	X01Y01 to X05Y06	3.06	2.19	-0.62	3.28	
22	X05Y06 to X01Y01	3.06	2.20	-0.59		-2.45
23	X01Y01 to X03Y04	2.04	1.33	-0.59	1.96	
24	X03Y04 to X01Y01	2.06	1.36	-0.57		-1.45
25	X01Y01 to X02Y03	1.70	0.62	-0.29	1.28	
26	X02Y03 to X01Y01	1.70	0.62	-0.28		-0.98
27	X01Y01 to X00Y02	1.76	0.73	-0.33	0.63	

Table A.1: Experiment data of moving time and energy need of driving unit and lifting unit at some positions

when $v_{d\text{ inp}} = 1\text{ m/s}$, $a_{d\text{ inp}} = 1\text{ m/s}^2$ and $v_{l\text{ inp}} = 1\text{ m/s}$, $a_{l\text{ inp}} = 1\text{ m/s}^2$.

	SRV' position	Driving unit			Lifting unit	
		$t_{d\text{ Exper}}$ (s)	$E_{dp\text{ Exper}}$ (kW)	$E_{dn\text{ Exper}}$ (kW)	$E_{lp\text{ Exper}}$ (kW)	$E_{ln\text{ Exper}}$ (kW)
1	X00Y02 to X20Y21	8.50	11.34	-1.31	13.56	
2	X20Y21 to X00Y02	8.40	11.53	-1.21		-9.68
3	X00Y02 to X20Y21	8.46	11.28	-1.30	13.50	
4	X20Y21 to X01Y01	8.10	10.69	-1.22		-10.08
5	X01Y01 to X20Y21	8.04	10.61	-1.29	14.19	
6	X20Y21 to X01Y01	8.00	10.53	-1.18		-10.24
7	X01Y01 to X19Y20	7.76	10.13	-1.36	13.44	
8	X19Y20 to X01Y01	7.70	10.19	-1.30		-9.66
9	X01Y01 to X17Y18	7.06	9.06	-1.34	12.07	
10	X17Y18 to X01Y01	7.08	9.38	-1.31		-8.75
11	X01Y01 to X15Y16	6.40	8.09	-1.27	10.62	
12	X15Y16 to X01Y01	6.34	8.11	-1.26		-7.69
13	X01Y01 to X13Y14	5.70	7.07	-1.32	9.00	
14	X13Y14 to X01Y01	5.76	7.20	-1.28		-6.52
15	X01Y01 to X11Y12	4.98	5.92	-1.18	7.60	
16	X11Y12 to X01Y01	5.06	5.96	-1.24		-5.58
17	X01Y01 to X09Y10	4.30	4.89	-1.19	6.26	
18	X09Y10 to X01Y01	4.26	5.03	-1.22		-4.46
19	X01Y01 to X07Y08	3.64	4.02	-1.27	4.90	
20	X07Y08 to X01Y01	3.70	4.14	-1.32		-3.62
21	X01Y01 to X05Y06	2.90	2.90	-1.14	3.22	
22	X05Y06 to X01Y01	2.96	2.87	-1.09		-2.47
23	X01Y01 to X03Y04	2.26	1.38	-0.57	1.94	
24	X03Y04 to X01Y01	2.30	1.33	-0.59		-1.50
25	X01Y01 to X02Y03	1.40	0.64	-0.29	1.29	
26	X02Y03 to X01Y01	1.42	0.61	-0.29		-1.00
27	X01Y01 to X00Y02	1.44	0.75	-0.32	0.62	

Table A.2: Experiment data of moving time and energy need of driving unit and lifting unit at some positions

when $v_{dinp} = 1.5\text{ m/s}$, $a_{dinp} = 1\text{ m/s}^2$ and $v_{linp} = 1.5\text{ m/s}$, $a_{linp} = 1\text{ m/s}^2$.

	SRV' position	Driving unit			Lifting unit	
		$t_{d\text{ Exper}}$ (s)	$E_{dp\text{ Exper}}$ (kW)	$E_{dn\text{ Exper}}$ (kW)	$E_{lp\text{ Exper}}$ (kW)	$E_{ln\text{ Exper}}$ (kW)
1	X00Y02 to X20Y21	7.20	13.17	-2.13	13.66	
2	X20Y21 to X00Y02	7.24	13.34	-2.02		-9.75
3	X00Y02 to X20Y21	7.18	12.70	-1.96	13.56	
4	X20Y21 to X01Y01	7.00	12.15	-2.03		-10.02
5	X01Y01 to X20Y21	6.96	12.19	-2.11	14.15	
6	X20Y21 to X01Y01	7.00	12.46	-2.19		-10.31
7	X01Y01 to X19Y20	6.80	11.24	-1.90	13.49	
8	X19Y20 to X01Y01	6.76	11.59	-2.06		-9.78
9	X01Y01 to X17Y18	6.22	10.38	-2.06	11.99	
10	X17Y18 to X01Y01	6.20	10.36	-2.00		-8.76
11	X01Y01 to X15Y16	5.76	9.32	-2.08	10.61	
12	X15Y16 to X01Y01	5.80	9.44	-1.95		-7.80
13	X01Y01 to X13Y14	5.26	8.22	-2.14	8.94	
14	X13Y14 to X01Y01	5.20	8.15	-1.85		-6.60
15	X01Y01 to X11Y12	4.66	6.79	-2.16	7.56	
16	X11Y12 to X01Y01	4.80	7.23	-1.98		-5.60
17	X01Y01 to X09Y10	4.20	5.95	-2.16	6.18	
18	X09Y10 to X01Y01	4.18	5.71	-1.79		-4.57
19	X01Y01 to X07Y08	3.50	4.24	-1.60	4.84	
20	X07Y08 to X01Y01	3.54	4.35	-1.56		-3.68
21	X01Y01 to X05Y06	3.02	2.72	-1.10	3.30	
22	X05Y06 to X01Y01	3.00	2.73	-1.06		-2.50
23	X01Y01 to X03Y04	2.16	1.34	-0.57	1.95	
24	X03Y04 to X01Y01	2.20	1.24	-0.52		-1.50
25	X01Y01 to X02Y03	1.52	0.60	-0.26	1.30	
26	X02Y03 to X01Y01	1.50	0.58	-0.25		-1.00
27	X01Y01 to X00Y02	1.50	0.70	-0.28	0.63	

Table A.3: Experiment data of moving time and energy need of driving unit and lifting unit at some positions

when $v_{dinp} = 2\text{ m/s}$, $a_{dinp} = 1\text{ m/s}^2$ and $v_{linp} = 2\text{ m/s}$, $a_{linp} = 1\text{ m/s}^2$.

	SRV' position	Driving unit			Lifting unit	
		$t_{d\text{ Exper}}$ (s)	$E_{dp\text{ Exper}}$ (kW)	$E_{dn\text{ Exper}}$ (kW)	$E_{lp\text{ Exper}}$ (kW)	$E_{ln\text{ Exper}}$ (kW)
1	X00Y02 to X20Y21	6.70	15.52	-2.78	13.70	
2	X20Y21 to X00Y02	6.66	15.38	-2.64		-9.51
3	X00Y02 to X20Y21	6.72	15.08	-2.73	13.61	
4	X20Y21 to X01Y01	6.50	14.62	-3.09		-9.85
5	X01Y01 to X20Y21	6.44	14.30	-2.88	14.27	
6	X20Y21 to X01Y01	6.48	14.55	-3.22		-10.06
7	X01Y01 to X19Y20	6.28	13.51	-2.92	13.60	
8	X19Y20 to X01Y01	6.32	13.78	-3.12		-9.50
9	X01Y01 to X17Y18	5.90	12.40	-3.03	12.03	
10	X17Y18 to X01Y01	5.92	11.86	-2.76		-8.51
11	X01Y01 to X15Y16	5.50	10.75	-2.87	10.79	
12	X15Y16 to X01Y01	5.44	10.98	-3.13		-7.63
13	X01Y01 to X13Y14	5.16	9.53	-2.98	8.98	
14	X13Y14 to X01Y01	5.02	9.34	-2.84		-6.44
15	X01Y01 to X11Y12	4.68	7.82	-2.43	7.62	
16	X11Y12 to X01Y01	4.58	7.58	-2.28		-5.51
17	X01Y01 to X09Y10	4.04	5.93	-1.97	6.29	
18	X09Y10 to X01Y01	4.00	5.92	-1.96		-4.53
19	X01Y01 to X07Y08	3.66	4.28	-1.55	4.88	
20	X07Y08 to X01Y01	3.64	4.49	-1.60		-3.60
21	X01Y01 to X05Y06	3.12	2.80	-1.07	3.32	
22	X05Y06 to X01Y01	3.02	2.81	-1.10		-2.48
23	X01Y01 to X03Y04	1.94	1.36	-0.59	1.95	
24	X03Y04 to X01Y01	1.98	1.31	-0.54		-1.48
25	X01Y01 to X02Y03	1.60	0.63	-0.29	1.30	
26	X02Y03 to X01Y01	1.62	0.66	-0.28		-1.00
27	X01Y01 to X00Y02	1.64	0.72	-0.32	0.64	

Table A.4: Experiment data of moving time and energy need of driving unit and lifting unit at some positions

when $v_{dinp} = 2.5\text{ m/s}$, $a_{dinp} = 1\text{ m/s}^2$ and $v_{linp} = 2.5\text{ m/s}$, $a_{linp} = 1\text{ m/s}^2$.

	SRV' position	Driving unit			Lifting unit	
		$t_{d\text{ Exper}}$ (s)	$E_{dp\text{ Exper}}$ (kW)	$E_{dn\text{ Exper}}$ (kW)	$E_{lp\text{ Exper}}$ (kW)	$E_{ln\text{ Exper}}$ (kW)
1	X00Y02 to X20Y21	6.50	16.48	-4.25	13.57	
2	X20Y21 to X00Y02	6.56	15.99	-4.04		-9.69
3	X00Y02 to X20Y21	6.52	16.13	-4.33	13.47	
4	X20Y21 to X01Y01	6.36	15.06	-3.82		-10.37
5	X01Y01 to X20Y21	6.38	15.12	-4.35	14.23	
6	X20Y21 to X01Y01	6.36	14.48	-3.81		-10.21
7	X01Y01 to X19Y20	6.16	14.24	-3.86	13.31	
8	X19Y20 to X01Y01	6.20	14.26	-4.03		-9.84
9	X01Y01 to X17Y18	5.84	12.38	-3.43	12.10	
10	X17Y18 to X01Y01	5.76	12.19	-3.62		-8.71
11	X01Y01 to X15Y16	5.48	10.48	-3.11	10.58	
12	X15Y16 to X01Y01	5.42	10.67	-3.42		-7.70
13	X01Y01 to X13Y14	5.20	9.09	-2.86	8.95	
14	X13Y14 to X01Y01	5.06	8.90	-2.76		-6.63
15	X01Y01 to X11Y12	4.66	7.31	-2.55	7.52	
16	X11Y12 to X01Y01	4.68	7.19	-2.30		-5.60
17	X01Y01 to X09Y10	4.14	5.68	-1.97	6.28	
18	X09Y10 to X01Y01	4.12	5.51	-1.80		-4.56
19	X01Y01 to X07Y08	3.70	4.11	-1.51	4.83	
20	X07Y08 to X01Y01	3.66	4.10	-1.41		-3.53
21	X01Y01 to X05Y06	2.96	2.71	-1.06	3.23	
22	X05Y06 to X01Y01	2.96	2.59	-1.00		-2.41
23	X01Y01 to X03Y04	2.22	1.25	-0.48	1.96	
24	X03Y04 to X01Y01	2.14	1.22	-0.47		-1.50
25	X01Y01 to X02Y03	1.54	0.59	-0.23	1.29	
26	X02Y03 to X01Y01	1.52	0.58	-0.23		-1.00
27	X01Y01 to X00Y02	1.56	0.68	-0.29	0.62	

Table A.5: Experiment data of moving time and energy need of driving unit and lifting unit at some positions

when $v_{dinp} = 3\text{ m/s}$, $a_{dinp} = 1\text{ m/s}^2$ and $v_{linp} = 3\text{ m/s}$, $a_{linp} = 1\text{ m/s}^2$.

	SRV' position	Driving unit			Lifting unit	
		$t_{d\text{ Exper}}$ (s)	$E_{dp\text{ Exper}}$ (kW)	$E_{dn\text{ Exper}}$ (kW)	$E_{lp\text{ Exper}}$ (kW)	$E_{ln\text{ Exper}}$ (kW)
1	X00Y02 to X20Y21	7.70	12.01	-1.52	13.67	
2	X20Y21 to X00Y02	7.74	12.11	-1.55		-9.66
3	X00Y02 to X20Y21	7.72	11.77	-1.48	13.61	
4	X20Y21 to X01Y01	7.36	11.18	-1.53		-10.16
5	X01Y01 to X20Y21	7.40	11.33	-1.61	14.23	
6	X20Y21 to X01Y01	7.42	11.50	-1.65		-10.04
7	X01Y01 to X19Y20	7.02	10.77	-1.54	13.44	
8	X19Y20 to X01Y01	7.00	10.62	-1.50		-9.60
9	X01Y01 to X17Y18	6.36	9.62	-1.55	12.05	
10	X17Y18 to X01Y01	6.34	9.80	-1.55		-8.70
11	X01Y01 to X15Y16	5.72	8.56	-1.50	10.70	
12	X15Y16 to X01Y01	5.68	8.50	-1.53		-7.61
13	X01Y01 to X13Y14	5.00	7.56	-1.55	9.01	
14	X13Y14 to X01Y01	5.04	7.61	-1.58		-6.47
15	X01Y01 to X11Y12	4.40	6.49	-1.51	7.68	
16	X11Y12 to X01Y01	4.36	6.51	-1.50		-5.49
17	X01Y01 to X07Y08	3.00	4.45	-1.51	4.91	
18	X07Y08 to X01Y01	3.00	4.51	-1.52		-3.59
19	X01Y01 to X05Y06	2.40	3.68	-1.63	3.34	
20	X05Y06 to X01Y01	2.40	3.50	-1.48		-2.42
21	X01Y01 to X03Y04	1.80	2.00	-1.02	1.94	
22	X03Y04 to X01Y01	1.82	1.93	-1.02		-1.45
23	X01Y01 to X02Y03	1.16	0.81	-0.44	1.28	
24	X02Y03 to X01Y01	1.20	0.82	-0.41		-0.98
25	X01Y01 to X00Y02	1.28	0.93	-0.52	0.62	

Table A.6: Experiment data of moving time and energy need of driving unit and lifting unit at some positions

when $v_{dinp} = 1.5\text{ m/s}$, $a_{dinp} = 2\text{ m/s}^2$ and $v_{linp} = 1.5\text{ m/s}$, $a_{linp} = 2\text{ m/s}^2$.

	SRV' position	Driving unit			Lifting unit	
		$t_{d\text{ Exper}}$ (s)	$E_{dp\text{ Exper}}$ (kW s)	$E_{dn\text{ Exper}}$ (kW s)	$E_{lp\text{ Exper}}$ (kW s)	$E_{ln\text{ Exper}}$ (kW s)
1	X00Y02 to X20Y21	6.28	13.91	-2.67	13.36	
2	X20Y21 to X00Y02	6.30	14.28	-2.60		-9.41
3	X00Y02 to X20Y21	6.32	14.09	-2.79	13.79	
4	X20Y21 to X01Y01	6.06	13.50	-2.94		-9.75
5	X01Y01 to X20Y21	6.02	13.34	-2.91	14.30	
6	X20Y21 to X01Y01	6.04	13.62	-2.88		-9.85
7	X01Y01 to X19Y20	5.80	12.62	-2.76	12.98	
8	X19Y20 to X01Y01	5.84	13.07	-2.96		-9.52
9	X01Y01 to X17Y18	5.38	11.63	-3.02	12.21	
10	X17Y18 to X01Y01	5.40	11.59	-2.78		-8.71
11	X01Y01 to X15Y16	4.92	10.66	-2.87	10.85	
12	X15Y16 to X01Y01	4.88	10.40	-2.76		-7.41
13	X01Y01 to X13Y14	4.38	9.46	-2.78	8.84	
14	X13Y14 to X01Y01	4.40	9.43	-2.66		-6.66
15	X01Y01 to X11Y12	3.90	8.07	-2.71	7.55	
16	X11Y12 to X01Y01	3.88	8.03	-2.71		-5.67
17	X01Y01 to X07Y08	2.88	5.88	-2.60	4.95	
18	X07Y08 to X01Y01	2.86	5.75	-2.55		-3.64
19	X01Y01 to X05Y06	2.34	4.36	-2.24	3.35	
20	X05Y06 to X01Y01	2.36	4.27	-2.18		-2.45
21	X01Y01 to X03Y04	1.72	1.89	-1.03	1.95	
22	X03Y04 to X01Y01	1.74	1.83	-1.03		-1.51
23	X01Y01 to X02Y03	1.48	0.83	-0.42	1.28	
24	X02Y03 to X01Y01	1.46	0.80	-0.42		-0.98
25	X01Y01 to X00Y02	1.50	0.91	-0.50	0.62	

Table A.7: Experiment data of moving time and energy need of driving unit and lifting unit at some positions

$$\text{when } v_{d\text{ imp}} = 2\text{ m/s}, a_{d\text{ imp}} = 2\text{ m/s}^2 \text{ and } v_{l\text{ imp}} = 2\text{ m/s}, a_{l\text{ imp}} = 2\text{ m/s}^2.$$

	SRV' position	Driving unit			Lifting unit	
		$t_{d\text{ Exper}}$ (s)	$E_{dp\text{ Exper}}$ (kW)	$E_{dn\text{ Exper}}$ (kW)	$E_{lp\text{ Exper}}$ (kW)	$E_{ln\text{ Exper}}$ (kW)
1	X00Y02 to X20Y21	5.60	18.12	-4.13	13.82	
2	X20Y21 to X00Y02	5.62	18.19	-4.04		-9.48
3	X00Y02 to X20Y21	5.58	17.88	-3.83	13.87	
4	X20Y21 to X01Y01	5.34	17.14	-3.83		-9.80
5	X01Y01 to X20Y21	5.40	16.73	-3.83	14.24	
6	X20Y21 to X01Y01	5.38	16.60	-4.02		-9.98
7	X01Y01 to X19Y20	5.22	16.23	-4.25	13.66	
8	X19Y20 to X01Y01	5.22	15.77	-4.15		-9.48
9	X01Y01 to X17Y18	4.84	14.27	-3.92	12.16	
10	X17Y18 to X01Y01	4.80	14.65	-4.14		-8.39
11	X01Y01 to X15Y16	4.46	13.32	-4.06	10.85	
12	X15Y16 to X01Y01	4.40	13.65	-4.42		-7.50
13	X01Y01 to X13Y14	4.02	11.82	-4.25	9.10	
14	X13Y14 to X01Y01	4.00	12.05	-4.39		-6.32
15	X01Y01 to X11Y12	3.60	10.24	-3.99	7.78	
16	X11Y12 to X01Y01	3.52	10.84	-4.38		-5.46
17	X01Y01 to X09Y10	3.20	9.23	-4.07	6.35	
18	X09Y10 to X01Y01	3.22	9.08	-4.16		-4.47
19	X01Y01 to X07Y08	2.76	6.86	-3.68	4.99	
20	X07Y08 to X01Y01	2.74	6.75	-3.38		-3.50
21	X01Y01 to X05Y06	2.24	4.30	-2.20	3.31	
22	X05Y06 to X01Y01	2.24	4.26	-2.23		-2.45
23	X01Y01 to X03Y04	1.68	1.98	-1.03	1.95	
24	X03Y04 to X01Y01	1.74	1.91	-0.97		-1.48
25	X01Y01 to X02Y03	1.40	0.81	-0.43	1.29	
26	X02Y03 to X01Y01	1.38	0.82	-0.42		-0.98
27	X01Y01 to X00Y02	1.42	0.92	-0.52	0.61	

Table A.8: Experiment data of moving time and energy need of driving unit and lifting unit at some positions

when $v_{dinp} = 2.5\text{ m/s}$, $a_{dinp} = 2\text{ m/s}^2$ and $v_{linp} = 2.5\text{ m/s}$, $a_{linp} = 2\text{ m/s}^2$.

	SRV' position	Driving unit			Lifting unit	
		$t_{d\text{ Exper}}$ (s)	$E_{dp\text{ Exper}}$ (kW)	$E_{dn\text{ Exper}}$ (kW)	$E_{lp\text{ Exper}}$ (kW)	$E_{ln\text{ Exper}}$ (kW)
1	X00Y02 to X20Y21	5.08	19.46	-5.85	13.80	
2	X20Y21 to X00Y02	5.14	19.91	-6.11		-9.71
3	X00Y02 to X20Y21	5.06	19.30	-5.89	13.74	
4	X20Y21 to X01Y01	4.98	18.81	-6.48		-10.35
5	X01Y01 to X20Y21	4.96	17.90	-5.85	14.37	
6	X20Y21 to X01Y01	5.00	18.82	-6.41		-9.86
7	X01Y01 to X19Y20	4.80	17.64	-5.87	13.65	
8	X19Y20 to X01Y01	4.84	18.12	-6.14		-9.60
9	X01Y01 to X17Y18	4.46	16.19	-5.83	12.33	
10	X17Y18 to X01Y01	4.52	16.24	-6.22		-8.79
11	X01Y01 to X15Y16	4.20	15.37	-6.41	10.63	
12	X15Y16 to X01Y01	4.16	14.71	-5.88		-7.70
13	X01Y01 to X13Y14	3.80	13.74	-5.85	9.00	
14	X13Y14 to X01Y01	3.76	13.36	-5.80		-6.58
15	X01Y01 to X11Y12	3.46	11.91	-5.58	7.68	
16	X11Y12 to X01Y01	3.60	12.22	-5.87		-5.47
17	X01Y01 to X09Y10	3.10	9.28	-5.05	6.28	
18	X09Y10 to X01Y01	3.08	9.23	-4.52		-4.55
19	X01Y01 to X07Y08	2.82	7.05	-3.77	4.95	
20	X07Y08 to X01Y01	2.84	6.76	-3.62		-3.60
21	X01Y01 to X05Y06	2.24	4.37	-2.44	3.32	
22	X05Y06 to X01Y01	2.26	4.38	-2.27		-2.42
23	X01Y01 to X03Y04	1.82	1.92	-1.03	1.96	
24	X03Y04 to X01Y01	1.84	1.83	-1.04		-1.45
25	X01Y01 to X02Y03	1.18	0.81	-0.43	1.29	
26	X02Y03 to X01Y01	1.20	0.77	-0.45		-1.00
27	X01Y01 to X00Y02	1.32	0.88	-0.48	0.61	

Table A.9: Experiment data of moving time and energy need of driving unit and lifting unit at some positions

when $v_{dinp} = 3\text{ m/s}$, $a_{dinp} = 2\text{ m/s}^2$ and $v_{linp} = 3\text{ m/s}$, $a_{linp} = 2\text{ m/s}^2$.

	SRV' position	Driving unit			Lifting unit	
		$t_{d\text{ Exper}}$ (s)	$E_{dp\text{ Exper}}$ (kW)	$E_{dn\text{ Exper}}$ (kW)	$E_{lp\text{ Exper}}$ (kW)	$E_{ln\text{ Exper}}$ (kW)
1	X00Y02 to X20Y21	4.86	24.14	-8.30	13.95	
2	X20Y21 to X00Y02	4.90	23.25	-8.17		-9.55
3	X00Y02 to X20Y21	4.84	22.74	-7.98	13.73	
4	X20Y21 to X01Y01	4.70	21.48	-7.54		-10.10
5	X01Y01 to X20Y21	4.76	22.07	-7.77	14.19	
6	X20Y21 to X01Y01	4.74	21.98	-8.46		-10.00
7	X01Y01 to X19Y20	4.60	20.91	-7.86	13.47	
8	X19Y20 to X01Y01	4.58	21.34	-8.11		-9.59
9	X01Y01 to X17Y18	4.30	19.50	-7.83	12.02	
10	X17Y18 to X01Y01	4.34	19.25	-7.85		-8.38
11	X01Y01 to X15Y16	4.00	17.11	-7.51	10.60	
12	X15Y16 to X01Y01	4.16	18.01	-8.37		-7.56
13	X01Y01 to X13Y14	3.80	15.63	-7.15	9.04	
14	X13Y14 to X01Y01	3.82	15.71	-7.30		-6.45
15	X01Y01 to X09Y10	3.06	9.57	-4.55	6.35	
16	X09Y10 to X01Y01	3.08	9.54	-4.97		-4.44
17	X01Y01 to X07Y08	2.82	7.01	-3.49	4.89	
18	X07Y08 to X01Y01	2.78	6.87	-3.34		-3.60
19	X01Y01 to X05Y06	2.22	4.29	-2.23	3.30	
20	X05Y06 to X01Y01	2.26	4.13	-2.18		-2.45
21	X01Y01 to X03Y04	1.82	1.95	-1.06	1.98	
22	X03Y04 to X01Y01	1.84	1.92	-1.04		-1.48
23	X01Y01 to X02Y03	1.20	0.81	-0.43	1.28	
24	X02Y03 to X01Y01	1.20	0.81	-0.44		-1.00
25	X01Y01 to X00Y02	1.30	0.95	-0.48	0.61	

Table A.10: Experiment data of moving time and energy need of driving unit and lifting unit at some positions when $v_{d\text{ imp}} = 3.5\text{ m/s}$, $a_{d\text{ imp}} = 2\text{ m/s}^2$ and $v_{l\text{ imp}} = 3.5\text{ m/s}$, $a_{l\text{ imp}} = 2\text{ m/s}^2$.

	SRV' position	Driving unit			Lifting unit	
		$t_{d\text{ Exper}}$ (s)	$E_{dp\text{ Exper}}$ (kW/s)	$E_{dn\text{ Exper}}$ (kW/s)	$E_{lp\text{ Exper}}$ (kW/s)	$E_{ln\text{ Exper}}$ (kW/s)
1	X00Y02 to X20Y21	4.86	25.21	-10.06	13.81	
2	X20Y21 to X00Y02	4.88	24.63	-9.73		-9.73
3	X00Y02 to X20Y21	4.88	25.51	-9.82	13.63	
4	X20Y21 to X01Y01	4.66	24.83	-10.82		-9.85
5	X01Y01 to X20Y21	4.66	24.67	-10.32	14.25	
6	X20Y21 to X01Y01	4.60	24.38	-10.64		-10.19
7	X01Y01 to X19Y20	4.50	23.51	-10.88	13.63	
8	X19Y20 to X01Y01	4.48	22.54	-9.83		-9.52
9	X01Y01 to X17Y18	4.28	20.94	-9.26	12.15	
10	X17Y18 to X01Y01	4.24	20.93	-9.59		-8.82
11	X01Y01 to X15Y16	4.02	17.93	-8.75	10.71	
12	X15Y16 to X01Y01	4.16	18.27	-9.01		-7.71
13	X01Y01 to X13Y14	3.76	14.91	-7.64	9.01	
14	X13Y14 to X01Y01	3.86	15.53	-7.64		-6.58
15	X01Y01 to X11Y12	3.60	11.88	-5.91	7.54	
16	X11Y12 to X01Y01	3.60	11.70	-5.97		-5.50
17	X01Y01 to X09Y10	3.14	9.72	-5.09	6.24	
18	X09Y10 to X01Y01	3.14	9.55	-5.08		-4.55
19	X01Y01 to X07Y08	2.74	6.76	-3.75	4.87	
20	X07Y08 to X01Y01	2.74	6.78	-3.79		-3.60
21	X01Y01 to X05Y06	2.30	4.36	-2.50	3.32	
22	X05Y06 to X01Y01	2.26	4.08	-2.32		-2.45
23	X01Y01 to X03Y04	1.74	1.91	-1.09	1.96	
24	X03Y04 to X01Y01	1.76	1.81	-1.06		-1.50
25	X01Y01 to X02Y03	1.30	0.83	-0.45	1.30	
26	X02Y03 to X01Y01	1.32	0.78	-0.44		-1.00
27	X01Y01 to X00Y02	1.40	0.91	-0.50	0.62	

Table A.11: Experiment data of moving time and energy need of driving unit and lifting unit at some positions when $v_{dimp} = 4\text{ m/s}$, $a_{dimp} = 2\text{ m/s}^2$ and $v_{limp} = 3\text{ m/s}$, $a_{limp} = 2\text{ m/s}^2$.

	SRV' position	Driving unit			Lifting unit	
		$t_{d\text{ Exper}}$ (s)	$E_{dp\text{ Exper}}$ (kW)	$E_{dn\text{ Exper}}$ (kW)	$E_{lp\text{ Exper}}$ (kW)	$E_{ln\text{ Exper}}$ (kW)
1	X00Y02 to X20Y21	6.14	14.22	-2.59	13.82	
2	X20Y21 to X00Y02	6.08	14.71	-2.80		-9.54
3	X00Y02 to X20Y21	6.12	14.39	-2.78	13.95	
4	X20Y21 to X01Y01	5.86	13.97	-2.72		-9.83
5	X01Y01 to X20Y21	5.80	13.65	-2.85	14.26	
6	X20Y21 to X01Y01	5.84	13.81	-2.84		-10.36
7	X01Y01 to X19Y20	5.60	12.92	-2.82	13.50	
8	X19Y20 to X01Y01	5.58	13.17	-2.71		-10.04
9	X01Y01 to X17Y18	5.10	12.06	-2.96	12.37	
10	X17Y18 to X01Y01	5.25	11.79	-2.94		-8.98
11	X01Y01 to X15Y16	4.64	10.93	-3.07	10.79	
12	X15Y16 to X01Y01	4.60	10.62	-2.68		-7.69
13	X01Y01 to X13Y14	4.10	9.33	-2.81	9.09	
14	X13Y14 to X01Y01	4.16	9.48	-2.88		-6.36
15	X01Y01 to X11Y12	3.68	8.51	-2.96	7.78	
16	X11Y12 to X01Y01	3.58	8.37	-2.80		-5.50
17	X01Y01 to X09Y10	3.30	7.19	-2.95	6.30	
18	X09Y10 to X01Y01	3.10	7.43	-3.03		-4.55
19	X01Y01 to X07Y08	2.64	6.19	-2.98	5.02	
20	X07Y08 to X01Y01	2.70	6.28	-3.04		-3.53
21	X01Y01 to X05Y06	2.22	4.97	-2.61	3.35	
22	X05Y06 to X01Y01	2.20	4.65	-2.48		-2.46
23	X01Y01 to X03Y04	1.60	1.99	-1.13	1.98	
24	X03Y04 to X01Y01	1.60	1.96	-1.11		-1.48
25	X01Y01 to X02Y03	1.30	0.70	-0.34	1.29	
26	X02Y03 to X01Y01	1.30	0.71	-0.35		-0.98
27	X01Y01 to X00Y02	1.33	0.82	-0.42	0.62	

Table A.12: Experiment data of moving time and energy need of driving unit and lifting unit at some positions when $v_{dinp} = 2\text{ m/s}$, $a_{dinp} = 3\text{ m/s}^2$ and $v_{linp} = 2\text{ m/s}$, $a_{linp} = 3\text{ m/s}^2$.

	SRV' position	Driving unit			Lifting unit	
		$t_{d\text{ Exper}}$ (s)	$E_{dp\text{ Exper}}$ (kW)	$E_{dn\text{ Exper}}$ (kW)	$E_{lp\text{ Exper}}$ (kW)	$E_{ln\text{ Exper}}$ (kW)
1	X00Y02 to X20Y21	5.36	19.34	-4.25	13.80	
2	X20Y21 to X00Y02	5.30	19.23	-4.27		-9.36
3	X00Y02 to X20Y21	5.28	18.66	-4.22	13.70	
4	X20Y21 to X01Y01	5.08	17.82	-4.23		-9.94
5	X01Y01 to X20Y21	5.12	17.49	-4.51	14.39	
6	X20Y21 to X01Y01	5.10	17.68	-4.32		-9.83
7	X01Y01 to X19Y20	4.90	16.91	-4.47	13.80	
8	X19Y20 to X01Y01	4.94	17.19	-4.41		-9.40
9	X01Y01 to X17Y18	4.50	15.51	-4.49	12.29	
10	X17Y18 to X01Y01	4.54	14.90	-4.14		-8.36
11	X01Y01 to X15Y16	4.12	13.79	-4.23	10.90	
12	X15Y16 to X01Y01	4.06	13.99	-4.15		-7.40
13	X01Y01 to X13Y14	3.80	12.36	-4.12	9.22	
14	X13Y14 to X01Y01	3.70	12.78	-4.49		-6.29
15	X01Y01 to X11Y12	3.40	10.71	-4.28	7.75	
16	X11Y12 to X01Y01	3.26	10.91	-4.32		-5.34
17	X01Y01 to X09Y10	2.86	9.32	-4.22	6.37	
18	X09Y10 to X01Y01	2.90	9.80	-4.28		-4.42
19	X01Y01 to X07Y08	2.50	8.19	-4.10	4.95	
20	X07Y08 to X01Y01	2.50	8.00	-3.88		-3.46
21	X01Y01 to X05Y06	2.10	5.09	-2.71	3.36	
22	X05Y06 to X01Y01	2.06	4.94	-2.73		-2.34
23	X01Y01 to X03Y04	1.80	2.06	-1.04	1.98	
24	X03Y04 to X01Y01	1.82	1.94	-1.06		-1.41
25	X01Y01 to X02Y03	1.32	0.74	-0.33	1.28	
26	X02Y03 to X01Y01	1.30	0.72	-0.32		-0.97
27	X01Y01 to X00Y02	1.37	0.86	-0.41	0.60	

Table A.13: Experiment data of moving time and energy need of driving unit and lifting unit at some positions when $v_{d\text{ inp}} = 2.5\text{ m/s}$, $a_{d\text{ inp}} = 3\text{ m/s}^2$ and $v_{l\text{ inp}} = 2.5\text{ m/s}$, $a_{l\text{ inp}} = 3\text{ m/s}^2$.

	SRV' position	Driving unit			Lifting unit	
		$t_{d\text{ Exper}}$ (s)	$E_{dp\text{ Exper}}$ (kW/s)	$E_{dn\text{ Exper}}$ (kW/s)	$E_{lp\text{ Exper}}$ (kW/s)	$E_{ln\text{ Exper}}$ (kW/s)
1	X00Y02 to X20Y21	5.00	20.52	-6.63	13.90	
2	X20Y21 to X00Y02	4.80	20.41	-6.23		-9.58
3	X00Y02 to X20Y21	4.96	19.69	-6.14	14.01	
4	X20Y21 to X01Y01	4.60	20.01	-6.56		-10.02
5	X01Y01 to X19Y20	4.70	19.49	-6.88	14.08	
6	X19Y20 to X01Y01	4.60	18.68	-6.16		-9.88
7	X01Y01 to X18Y19	4.26	18.23	-6.46	12.71	
8	X18Y19 to X01Y01	4.46	17.82	-6.51		-8.86
9	X01Y01 to X17Y18	4.10	17.57	-6.92	12.29	
10	X17Y18 to X01Y01	4.34	17.89	-6.70		-8.45
11	X01Y01 to X16Y17	4.00	16.59	-6.39	11.50	
12	X16Y17 to X01Y01	4.25	16.24	-6.23		-7.96
13	X01Y01 to X15Y16	3.96	15.68	-6.27	11.19	
14	X15Y16 to X01Y01	4.00	16.41	-6.35		-7.60
15	X01Y01 to X14Y15	3.80	14.87	-6.29	10.19	
16	X14Y15 to X01Y01	3.64	15.52	-6.39		-7.01
17	X01Y01 to X13Y14	3.56	14.44	-6.55	8.95	
18	X13Y14 to X01Y01	3.64	14.60	-6.42		-6.35
19	X01Y01 to X12Y13	3.46	14.16	-6.83	8.57	
20	X12Y13 to X01Y01	3.40	13.64	-6.43		-6.03
21	X01Y01 to X11Y12	3.34	13.42	-6.53	7.67	
22	X11Y12 to X01Y01	3.15	13.25	-6.79		-5.38
23	X01Y01 to X10Y11	3.14	11.98	-6.25	7.09	
24	X10Y11 to X01Y01	3.05	12.30	-6.79		-4.92
25	X01Y01 to X09Y10	2.82	11.00	-5.92	6.40	
26	X09Y10 to X01Y01	2.80	11.49	-6.07		-4.46
27	X01Y01 to X08Y09	2.70	10.15	-5.68	5.65	
28	X08Y09 to X01Y01	2.72	9.54	-5.32		-3.97
29	X01Y01 to X07Y08	2.65	8.05	-4.79	4.89	
30	X07Y08 to X01Y01	2.60	8.18	-4.58		-3.61
31	X01Y01 to X06Y07	2.50	6.75	-3.83	3.98	
32	X06Y07 to X01Y01	2.56	6.64	-3.89		-3.00
33	X01Y01 to X05Y06	2.32	5.06	-3.08	3.33	
34	X05Y06 to X01Y01	2.15	5.04	-2.85		-2.42
35	X01Y01 to X04Y05	2.06	3.49	-1.98	2.64	
36	X04Y05 to X01Y01	1.95	3.44	-1.89		-1.94
37	X01Y01 to X03Y04	1.65	2.01	-1.12	1.95	
38	X03Y04 to X01Y01	1.55	1.94	-1.12		-1.48
39	X01Y01 to X02Y03	1.30	0.70	-0.34	1.29	
40	X02Y03 to X01Y01	1.30	0.69	-0.35		-1.00
41	X01Y01 to X00Y02	1.32	0.80	-0.42	0.62	

Table A.14: Experiment data of moving time and energy need of driving unit and lifting unit at some positions when $v_{d\text{ inp}} = 3\text{ m/s}$, $a_{d\text{ inp}} = 3\text{ m/s}^2$ and $v_{l\text{ inp}} = 3\text{ m/s}$, $a_{l\text{ inp}} = 4\text{ m/s}^2$.

	SRV' position	Driving unit			Lifting unit	
		$t_{d\text{ Exper}}$ (s)	$E_{dp\text{ Exper}}$ (kW/s)	$E_{dn\text{ Exper}}$ (kW/s)	$E_{lp\text{ Exper}}$ (kW/s)	$E_{ln\text{ Exper}}$ (kW/s)
1	X00Y02 to X20Y21	4.54	24.47	-9.18	13.92	
2	X20Y21 to X00Y02	4.56	24.23	-8.85		-9.58
3	X00Y02 to X20Y21	4.50	24.16	-8.55	14.02	
4	X20Y21 to X01Y01	4.30	23.66	-8.36		-9.89
5	X01Y01 to X20Y21	4.36	23.26	-9.19	14.34	
6	X20Y21 to X01Y01	4.32	23.25	-8.91		10.00
7	X01Y01 to X19Y20	4.16	22.57	-9.10	13.65	
8	X19Y20 to X01Y01	4.22	22.45	-9.24		-9.46
9	X01Y01 to X16Y16	3.80	20.35	-9.24	10.89	
10	X16Y16 to X01Y01	3.72	19.23	-8.33		-7.35
11	X01Y01 to X13Y13	3.32	16.77	-8.19	8.29	
12	X13Y13 to X01Y01	3.30	17.10	-8.29		-5.69
13	X01Y01 to X12Y12	3.20	15.86	-8.09	7.75	
14	X12Y12 to X01Y01	3.22	15.67	-8.62		-5.30
15	X01Y01 to X10Y09	2.94	13.18	-7.47	5.59	
16	X10Y09 to X01Y01	2.90	13.66	-7.86		-3.97
17	X01Y01 to X06Y06	2.40	6.57	-3.67	3.31	
18	X06Y06 to X01Y01	2.30	6.64	-3.83		-2.37
19	X01Y01 to X04Y04	1.94	3.41	-2.07	2.00	
20	X04Y04 to X01Y01	1.96	3.29	-2.00		-1.48
21	X01Y01 to X03Y03	1.76	2.00	-1.09	1.30	
22	X03Y03 to X01Y01	1.80	1.95	-1.11		-1.00
23	X01Y01 to X02Y02	1.30	0.72	-0.35	0.64	
24	X02Y02 to X01Y01	1.30	0.67	-0.34		-0.48
25	X01Y01 to X00Y02	1.36	0.82	-0.42	0.60	

Table A.15: Experiment data of moving time and energy need of driving unit and lifting unit at some positions when $v_{d\text{ imp}} = 3.5\text{ m/s}$, $a_{d\text{ imp}} = 3\text{ m/s}^2$ and $v_{l\text{ imp}} = 3.5\text{ m/s}$, $a_{l\text{ imp}} = 4\text{ m/s}^2$.

	SRV' position	Driving unit			Lifting unit	
		$t_{d\text{ Exper}}$ (s)	$E_{dp\text{ Exper}}$ (kW/s)	$E_{dn\text{ Exper}}$ (kW/s)	$E_{lp\text{ Exper}}$ (kW/s)	$E_{ln\text{ Exper}}$ (kW/s)
1	X00Y02 to X20Y21	4.40	28.10	-10.80	13.90	
2	X20Y21 to X00Y02	4.42	28.90	-11.90		-9.53
3	X00Y02 to X20Y21	4.34	28.00	-11.20	14.00	
4	X20Y21 to X01Y01	4.24	27.20	-11.50		-9.88
5	X01Y01 to X20Y21	4.20	26.30	-11.20	14.40	
6	X20Y21 to X01Y01	4.28	26.00	-11.80		-10.00
7	X01Y01 to X19Y20	4.12	26.80	-11.50	13.80	
8	X19Y20 to X01Y01	4.16	25.50	-10.80		-9.46
9	X01Y01 to X17Y18	3.80	23.00	-10.70	12.24	
10	X17Y18 to X01Y01	3.86	24.10	-11.50		-8.26
11	X01Y01 to X15Y16	3.64	22.30	-10.80	11.00	
12	X15Y16 to X01Y01	3.60	21.00	-10.80		-7.64
13	X01Y01 to X13Y14	3.48	18.80	-9.96	9.23	
14	X13Y14 to X01Y01	3.28	19.10	-11.10		-6.40
15	X01Y01 to X11Y12	3.26	15.30	-8.16	7.50	
16	X11Y12 to X01Y01	3.20	14.90	-8.14		-5.32
17	X01Y01 to X09Y10	2.88	12.30	-6.70	6.30	
18	X09Y10 to X01Y01	2.82	11.30	-6.49		-4.40
19	X01Y01 to X07Y08	2.58	8.50	-4.96	4.94	
20	X07Y08 to X01Y01	2.62	7.97	-4.55		-3.55
21	X01Y01 to X05Y06	2.30	5.17	-2.97	3.29	
22	X05Y06 to X01Y01	2.26	5.07	-2.93		-2.40
23	X01Y01 to X03Y04	1.88	1.94	-1.08	1.98	
24	X03Y04 to X01Y01	1.86	2.00	-1.07		-1.48
25	X01Y01 to X02Y03	1.40	0.72	-0.35	1.30	
26	X02Y03 to X01Y01	1.36	0.70	-0.35		-0.98
27	X01Y01 to X00Y02	1.36	0.82	-0.43	0.60	

Table A.16: Experiment data of moving time and energy need of driving unit and lifting unit at some positions when $v_{d\text{ inp}} = 4\text{ m/s}$, $a_{d\text{ inp}} = 3\text{ m/s}^2$ and $v_{l\text{ inp}} = 4\text{ m/s}$, $a_{l\text{ inp}} = 4\text{ m/s}^2$.

	SRV' position	Driving unit		
		$t_{d\text{ Exper}}$ (s)	$E_{dp\text{ Exper}}$ (kW/s)	$E_{dn\text{ Exper}}$ (kW/s)
1	X00Y02 to X20Y21	4.24	32.38	-12.28
2	X20Y21 to X00Y02	4.24	32.64	-13.58
3	X00Y02 to X20Y21	4.24	33.18	-13.02
4	X20Y21 to X01Y01	4.02	30.13	-12.47
5	X01Y01 to X19Y20	3.90	30.82	-13.78
6	X19Y20 to X01Y01	3.94	29.43	-12.40
7	X01Y01 to X18Y19	3.80	29.96	-13.46
8	X18Y19 to X01Y01	3.84	28.53	-13.52
9	X01Y01 to X17Y18	3.72	27.85	-12.64
10	X17Y18 to X01Y01	3.76	27.64	-13.64
11	X01Y01 to X16Y17	3.58	25.73	-12.35
12	X16Y17 to X01Y01	3.66	25.28	-12.58
13	X01Y01 to X15Y16	3.46	23.63	-10.83
14	X15Y16 to X01Y01	3.50	23.87	-12.31
15	X01Y01 to X14Y15	3.40	22.45	-10.91
16	X14Y15 to X01Y01	3.44	21.74	-11.09
17	X01Y01 to X13Y14	3.30	19.43	-9.36
18	X13Y14 to X01Y01	3.30	20.27	-10.33
19	X01Y01 to X12Y13	3.20	17.95	-9.36
20	X12Y13 to X01Y01	3.24	18.09	-9.14
21	X01Y01 to X11Y12	3.02	15.43	-8.22
22	X11Y12 to X01Y01	3.16	15.33	-7.93
23	X01Y01 to X10Y11	2.86	13.79	-7.10
24	X10Y11 to X01Y01	2.86	13.87	-7.58
25	X01Y01 to X09Y10	2.76	12.22	-6.54
26	X09Y10 to X01Y01	2.74	12.34	-6.55
27	X01Y01 to X08Y09	2.64	10.57	-5.72
28	X08Y09 to X01Y01	2.66	10.44	-5.47
29	X01Y01 to X07Y08	2.60	8.80	-4.58
30	X07Y08 to X01Y01	2.60	8.62	-4.37
31	X01Y01 to X06Y07	2.40	6.68	-3.52
32	X06Y07 to X01Y01	2.34	6.55	-3.79
33	X01Y01 to X05Y06	2.08	5.13	-2.84
34	X05Y06 to X01Y01	2.04	5.07	-2.66
35	X01Y01 to X04Y05	1.92	3.54	-1.93
36	X04Y05 to X01Y01	1.92	3.45	-1.85
37	X01Y01 to X03Y04	1.80	2.05	-1.07
38	X03Y04 to X01Y01	1.80	2.04	-1.06
39	X01Y01 to X02Y03	1.32	0.71	-0.34
40	X02Y03 to X01Y01	1.30	0.71	-0.32
41	X01Y01 to X00Y02	1.40	0.85	-0.38

Table A.17: Experiment data of moving time and energy need of driving unit and lifting unit at some positions when $v_{dinp} = 4.5\text{ m/s}$, $a_{dinp} = 3\text{ m/s}^2$.

Appendix B: The experimental coefficients of the driving unit

- When the driving unit moves with the constant speed, the acceleration is zero. The coefficient $K_t = K_{ics\text{exper}}$ is determined by Table B.1.

$v_{d\text{inp}}$ (m/s)	1	1.5	2	2.5	3	3.5	4	4.5
$K_{ics\text{exper}}$	5.78	7.2	8.34	9.76	10.98	12.42	13.84	15.15

Table B.1: The coefficient $K_{ics\text{exper}}$ depends on the input speed of the driving unit.

- When the driving unit is acceleration, the coefficient $K_t = K_{ta\text{exper}}$ is determined by Table B.2.

$v_{d\text{inp}}$ (m/s)	1	1.5	2	2.5	3	1.5	2	2.5	3	3.5	4	2	2.5	3	3.5	4	4.5
$a_{d\text{inp}}$ (m/s ²)	1	1	1	1	1	2	2	2	2	2	2	3	3	3	3	3	3
$K_{ta\text{exper}}$	1.36	1.39	1.41	1.54	1.54	1.28	1.23	1.35	1.30	1.38	1.42	1.21	1.29	1.26	1.26	1.30	1.37

Table B.2: The coefficient $K_{ta\text{exper}}$ depends on both of the input speed $v_{d\text{inp}}$ and acceleration $a_{d\text{inp}}$ of the driving unit.

- When the driving unit is deceleration, the coefficient $K_t = K_{td\text{exper}}$ is determined by Table B.3.

$v_{d\text{inp}}$ (m/s)	1	1.5	2	2.5	3	1.5	2	2.5	3	3.5	4	2	2.5	3	3.5	4	4.5
$a_{d\text{inp}}$ (m/s ²)	1	1	1	1	1	2	2	2	2	2	2	3	3	3	3	3	3
$K_{td\text{exper}}$	0.69	0.63	0.58	0.53	0.51	0.74	0.75	0.70	0.70	0.69	0.68	0.76	0.73	0.75	0.76	0.74	0.69

Table B.3: The coefficient $K_{td\text{exper}}$ depends on both of the input speed $v_{d\text{inp}}$ and acceleration $a_{d\text{inp}}$ of the driving unit.

Appendix C: Proof by Induction in Section 6.1.3

The logical choice method the pairs of DOC in the entire system to achieve the best efficiencies of the energy need and the moving time: *The farthest storage compartment and the farthest retrieval compartment by horizontal direction are always selected as the first pair and then the second pair is selected at the second farthest storage and retrieval compartments and so on. Finally, the storage and retrieval compartments at the nearest positions to I/O point by horizontal direction are chosen.* (C.1)

Solution

Base case:

When $n=1$ (a pair of DOC) we have: The farther from the I/O point a storage position and a retrieval position chosen for a pair of DOC are and the nearer to each other by horizontal direction they are, the higher the saving efficiencies of the energy need and the moving time in DOC are (Chapter 5).

When $n=2$ (two pairs of DOC) the general method to choose two pairs of DOC from any four positions to achieve the best efficiencies of the energy need and the moving time is shown: The farthest storage position is chosen in a pair with the farthest retrieval position and the remaining storage position is chosen in a pair with the remaining retrieval position (Section 6.1).

Induction hypothesis:

Assume that (C.1) is correct for $n= k \in \mathbb{Z}^+$ (k pairs of DOC). (C.2)

Induction step:

We will now show that $n=k+1$ then (C.1) is correct.

There are $(k+1)$ the storage positions (st_1 to st_{k+1}) and $(k+1)$ the retrieval positions (re_1 to re_{k+1}). It is assumed that: i is big and then the positions of st_i and re_i are far from I/O point by horizontal direction and vice versa.

Assume that st_u and re_v is a pair of DOC in the logical choice method. We must prove $u = v$ then the logical choice method satisfies.

From (C.2), $(k+1)$ pairs of DOC in the logical choice method when $u < v$ are determined by (C.3):

$$\left\{ (st_1, re_1); (st_2, re_2); \dots; (st_{u-1}, re_{u-1}); (st_{u+1}, re_u); (st_{u+2}, re_{u+1}); \dots; (st_v, re_{v-1}); (st_{v+1}, re_{v+1}); \dots; (st_{k+1}, re_{k+1}); \right\} \text{ and } (st_u, re_v) \quad (C.3)$$

In $(k+1)$ pairs of (C.3), we consider $(v-u+1)$ pairs:

$$\left\{ (st_{u+1}, re_u); (st_{u+2}, re_{u+1}); \dots; (st_v, re_{v-1}) \text{ and } (st_u, re_v) \right\} \quad (C.4)$$

It is easy to know: the saving efficiencies of the energy need and the moving time in (C.4) always are smaller than the ones in (C.5):

$$\{(st_u, re_u); (st_{u+1}, re_{u+1}); \dots; (st_{v-1}, re_{v-1}) \text{ and } (st_v, re_v)\} \quad (\text{C.5})$$

It means that st_u to re_v can not be a pair of DOC in the logical choice method when $u < v$.

It is similarly proven: st_u to re_v can not be a pair of DOC in the logical choice method when $u > v$.

As a result, $u = v$ when st_u to re_v is a pair of DOC in the logical choice method.

So $n=k+1$ then (C.1) is correct. Hence by mathematical induction (C.1) is correct for all positive integers n .

Appendix D: The ABC zonings when kinematic parameters change.

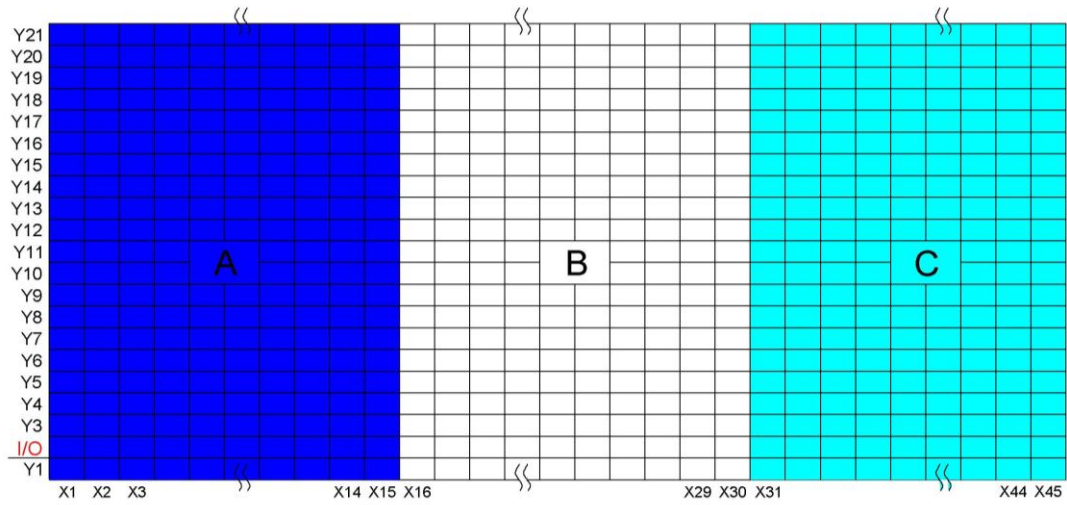

Figure D.1: The time ABC zoning when kinematic parameters of the lifting unit are maximum values.

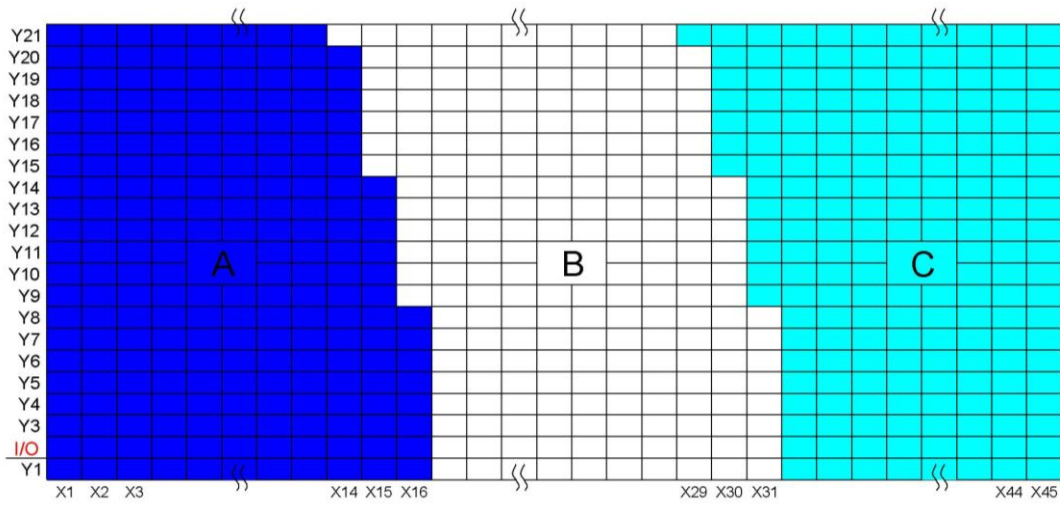

Figure D.2: The energy ABC zoning
when $v_{dinp} = 2 \text{ m/s}$, $a_{dinp} = 3 \text{ m/s}^2$ and $v_{linp} = 4 \text{ m/s}$, $a_{linp} = 4 \text{ m/s}^2$.

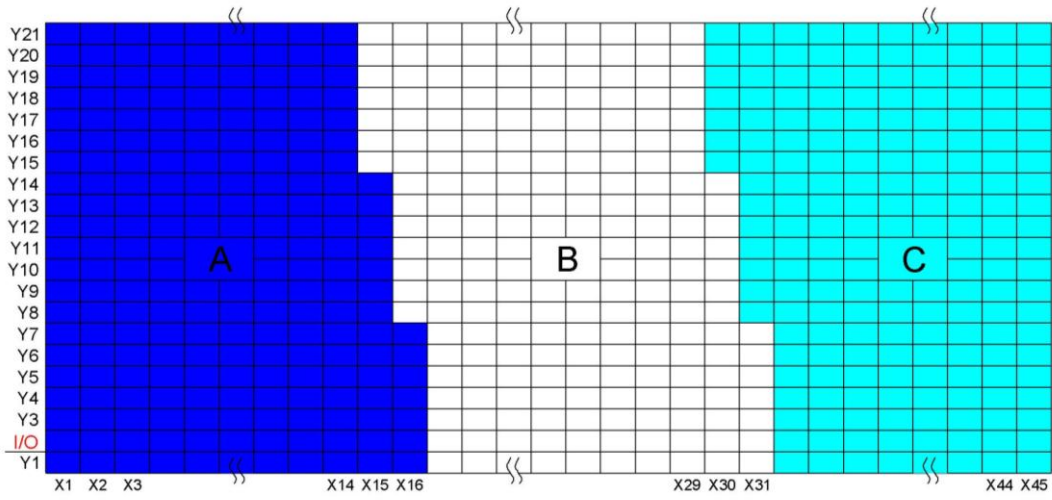

Figure D.3: The energy ABC zoning

when $v_{d\text{inp}} = 3 \div 4 \text{ m/s}$, $a_{d\text{inp}} = 3 \text{ m/s}^2$ and $v_{l\text{inp}} = 4 \text{ m/s}$, $a_{l\text{inp}} = 4 \text{ m/s}^2$.

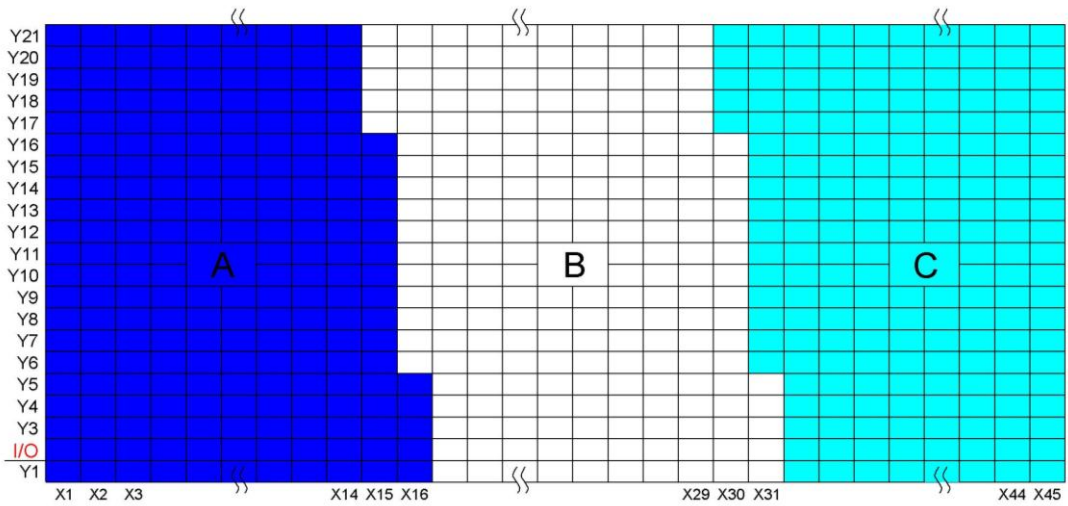

Figure D.4: The energy ABC zoning

when $v_{d\text{inp}} = 5 \text{ m/s}$, $a_{d\text{inp}} = 3 \text{ m/s}^2$ and $v_{l\text{inp}} = 4 \text{ m/s}$, $a_{l\text{inp}} = 4 \text{ m/s}^2$.