

# Imaging the functional networks influenced by VTA stimulation

**Dissertation**

Zur Erlangung des akademischen Grades

**doctor rerum naturalium (Dr. rer. nat.)**

genehmigt durch die Fakultät für Naturwissenschaften  
der Otto-von-Guericke-Universität Magdeburg

von

Magister Marta Jadwiga Brocka  
geb. am 19.10.1989 in Żory

Gutachter: Prof. Dr. Frank Ohl  
Prof. Dr. Mathias Hoehn

Eingereicht am: 6.02.2018; verteidigt am: 24.09.2018

*O to chodzi jedynie,  
By naprzód wciąż iść śmiało,  
Bo zawsze się dochodzi  
Gdzie indziej, niż się chciało.*

*The only point is  
To go ahead boldly  
Because anyway you will always end up  
In a different place than you wanted*

Leopold Staff, Odys

*Mojej Babci*  
*For my Grandma*

## Acknowledgements

Many people have contributed to this work physically, formally and emotionally. I am not even sure if I am able to recall all of them. However, if I did forget anyone, please blame my memory, not my lack of gratitude.

Success (and as such I am defining the submission of this thesis) has in this particular case three fathers. I want to thank my Doktorvater- Prof. Frank Ohl, for giving me the opportunity to perform the experiments and write my PhD thesis in the LIN, and for the support in different forms I received from him in all the years of my PhD. Many thanks to Prof. Frank Angenstein for his cooperativeness, engagement and great patience for my questions and remarks. I appreciate mostly his great calmness in every situation. And last, but definitely not least, I would like to acknowledge Dr. Michael Lippert for almost five years of our common work. I owe him a great deal of things I have learnt during the time I have spent in the LIN. I owe him also a lot of professional and emotional support. He was always accepting my mistakes with admirable amount of cold blood and tranquility.

There were many people who attributed to the experimental work. I would like to thank Dr. Jürgen Goldschmidt for making the SPECT available for us, and for his work and very helpful comments regarding the experiments and publications. Daniel Vincenz greatly contributed to the SPECT experiments and data analysis. Ines Heinemann (Bodewald) and Kristin Böttger spent long hours in the SPECT laboratory, providing not only good technical assistance but also good humor.

The voltammetry measurements would not be possible without Dr. Cornelia Helbing, as well as many optogenetic/fMRI sessions. All the hours spend in fMRI room would be definitely duller without Karla Krautwald. Many thanks to Dr. Thomas Scherf for the electro/fMRI experiments.

I would also like to thank the whole Neurooptics working group: Dr. Dr. Kentaroh Takagaki for his readiness in teaching me new things and for the help when I needed it; Dr. Tim Wanger for his optimism and balanced views; Gonzalo Arias-Gil for his positive, friendly, reasonable and sober attitude; Marcel Brosch especially for our common projects as PhD representatives; Janie (Zifeng) Xia for help and delicious food; Vivekanandhan Viswanathan for his good humour, enthusiasm, friendliness and great curry; Jennifer Tegtmeier for her energy and available car; Theresa Weidner for being there when I needed her and never letting me down; Silvia Vieweg for her hard work, excellent technical assistance and many forms of support.

Many thanks for Poles in Magdeburg: Ela Komarzyńska, Marysia Komarzyńska-Matysiak and Artur Matysiak for the feeling that I can count on them whatever happens; Gabrysia Matuszko for showing me how to deal with the problems; Kasia Wrzosek for being my travel companion; Kasia Grochowska for providing me with the solutions for my problems; Sandra Fieńko for her cheerful and sympathetic attitude.

I would also like to thank my work and free time companions: Torsten Stöter, Aida Hajizadeh, Maggie (Ma Jing), Marie Oule, Dr. Camilla Fusi, Ioana Butnaru, Dr. Gonca Bayraktar, Kritika Sudan, Mael Dumenieu, Alessandro Confettura, Dr. Sujoy Bera, Andrew Curren, Sebastian Samer, Sanchit Rathi, Eneko Pina and the others, for keeping me a bit further away from insanity.

During my time in Germany I also had a constant support from my Polish friends. I would like to thank Ula Górka, for showing me that impossible is possible; Ania Gręda for her advices and trust; Agnieszka Sidek for being a great host and for her organizational talent; Natalia Florek-Szotowicz for her long friendship; Justyna Piekara for her great sense of humor and our existential discussions. Finally, I would like to thank Weronika Waszczuk and Natalia Wilczek for their engagement, for the long hours spent on traveling and board games and for laughing at my problems.

Pegah Azizi was my first real friend I encountered in Magdeburg. Thank you, Pegah, for being my great traveling and working companion; for our endless discussions about life, culture and history; for hosting me in your flat for the whole month and in your home in Iran.

My family was always with me for better or for worse. I would like to thank them in Polish, since some of them do not speak English. Dziękuję moim rodzicom, Danucie i Andrzejowi Brockim, za wsparcie materialne i psychiczne przez te wszystkie lata i za dużą cierpliwość do moich narzekań i humorów. Dziękuję mojej cioci, Joannie Fajdek, za stymulację intelektualną i zaangażowanie. Dziękuję Przemkowi Brockiemu za bycie świetnym bratem i za wino domowej roboty, Magdzie Brockiej za rozwagę i spokój i Jasiowi Brockim za poprawianie mi humoru.

Finally I would like to thank Francisco Santos da Silva, my best friend, for being hidden optimist and for facing my moods and (feminist, life-is-unfair, I-want-to-die, why-did-Polish-people-vote-for-these-guys) rants with great patience and calmness. He provided me with an invaluable emotional support, nice memories, interesting and stimulating discussions. Eu te amo.

This work was supported by the LIN Special Project.

# Table of contents

Abbreviations.....	1
Abstract.....	2
Zusammenfassung.....	3
1. Introduction.....	3
1.1 VTA and dopamine.....	5
1.1.1 Anatomy, cell types and connections .....	5
1.1.2 Dopaminergic receptors.....	7
1.1.3 Reward prediction error theory .....	7
1.1.4 Electrophysiological properties .....	7
1.1.5 Intracranial self-stimulation (ICSS).....	8
1.2 Optogenetics.....	9
1.2.1 Optogenetics to study the role of dopaminergic network.....	9
1.2.2 Animal models used in optogenetic studies .....	9
1.3 Functional neuroimaging .....	11
1.3.1 Neurovascular coupling .....	11
1.3.2 The BOLD signal and neurovascular coupling .....	11
1.3.2.1 Effects of dopamine release on BOLD signal .....	12
1.3.2.2 Considerations when combining fMRI and optogenetics .....	13
1.3.3 <sup>99m</sup> Tc-HMPAO-SPECT .....	14
1.3.3.1 SPECT imaging and dopamine release from the VTA.....	14
2. Aims of the study .....	15
3. Materials and methods .....	15
3.1 Subjects.....	15
3.2 Viral vectors and stereotaxic surgery.....	15
3.3 Implantation of the electrodes .....	16
3.4 ICSS .....	16
3.5 fMRI.....	17
3.6 Optogenetic stimulation.....	18
3.6.1 Pharmacological manipulation: D <sub>1,5</sub> receptor blockade .....	19
3.7 Electrical stimulation .....	19

3.7.1 Pharmacological manipulation: D <sub>1,5</sub> and NMDA receptor blockade .....	20
3.8 Data processing and analysis .....	20
3.9 SPECT .....	21
3.9.1 Data analysis .....	22
3.10 Fast-scan cyclic voltammetry (FSCV).....	22
3.11 Histology .....	23
4. Results .....	23
4.1 Study I.....	23
4.1.1 Evoked BOLD signal depends on cell-specificity of VTA stimulation .....	24
4.1.2 Blockade of dopaminergic D <sub>1,5</sub> receptors does not influence BOLD responses evoked by electrical stimulation .....	25
4.2 Study II.....	26
4.2.1 Intracranial self-stimulation is acquired at comparable levels in case of less-specific and dopamine specific stimulation .....	26
4.2.2 fMRI results confirmed findings from Study I.....	27
4.2.3 Optogenetic less-specific and dopamine specific stimulation has different effects on rCBF.....	30
4.2.4 Temporal dissociation between DA-release and BOLD signal.....	32
5. Discussion .....	35
5.1 Specificity of stimulation .....	35
5.2 Comparison to other optogenetic studies .....	36
5.3 Differences between fMRI and SPECT .....	37
5.4 Relevance for human studies.....	38
5.3.1 Constraints of translating results from animal studies to human studies .....	38
6. Conclusions.....	39
Erklärung.....	40
Scientific publications .....	41
Bibliography .....	42

# Abbreviations

99mTc-HMPAO	Technetium (99mTc) hexamethyl-propyleneamine oxime
ACC	Anterior cingulate cortex
ATP	Adenosine triphosphate
AAV	Adeno-associated virus
BOLD	Blood oxygenation level dependent
BSR	Brain stimulation reward
C1V1	Chimeric opsin variant composed of ChR1 and VChR1 fragments
CaMKII $\alpha$	Ca <sup>2+</sup> /calmodulin-dependent protein kinase II type $\alpha$
CBF	Cerebral blood flow
CT	Computer tomography
DA	Dopamine
DAQ	Data acquisition (card)
EF1 $\alpha$	Eukaryotic translation elongation factor 1 alpha
EPI	Echo planar imaging
eYFP	Enhanced yellow fluorescent protein
fMRI	Functional magnetic resonance imaging
FOV	Field of view
FSCV	Fast-scan cyclic voltammetry
FWHM	Full width at half maximum
GABA	Gamma-aminobutyric acid
GLM	General linear model
HbO	Oxy-hemoglobin
hChR2	Channelrhodopsin type 2 (containing codons optimized for mammalian expression)
HC	Hippocampus
HCl	Hydrogen chloride
ICSS	Intracranial self-stimulation
LFP	Local field potentials
mPFC	Medial prefrontal cortex
N.A	Numerical aperture
NAcc	Nucleus accumbens
NDF	Neutral density filter
NIRS	Near infrared spectroscopy
NMDA	N-methyl-D-aspartate
p2A	"Self-cleaving" peptide
PET	Positron emission tomography
RARE	Rapid Imaging with Refocused Echoes
SN	Substantia nigra
SPECT	Single-photon emission computed tomography
TE	Echo time
Th	Tyrosine hydroxylase
TR	Repetition time
VOI	Volume of interest
VTA	Ventral tegmental area
VTT	Ventral tegmental tail
WT	Wild type



## Abstract

The anatomical structure of the mesolimbic dopamine system has received considerable attention in the past and is therefore well known. It is largely unclear, however, to what degree activity in the system can be imaged with blood-flow based imaging modalities like fMRI and SPECT. Here we investigated how different types of VTA stimulation, differing in specificity for dopaminergic cells, cause functional network activity throughout the brain.

To investigate the impact of non-selective stimulation of VTA neurons on BOLD response, we performed electrical VTA stimulation in rats during fMRI. We observed broad activations in reward-related areas, such as the PFC/ACC, VTA and NAcc. Surprisingly, the application of a D<sub>1,5</sub> receptor blocker did not suppress these signals, indicating that they might not be caused by dopamine release.

To further examine the involvement of dopamine in mesolimbic neurovascular signals, we used two variants of optogenetic VTA stimulation, differing in dopamine specificity. In a less-specific stimulation condition we transduced neurons in wild type (WT) rats with an opsin under the CaMKII $\alpha$  promoter. In a dopamine-specific condition, Th-Cre rats were transduced with floxed opsin, resulting in selective opsin expression in dopaminergic cells. All animals underwent optogenetic intracranial self-stimulation (ICSS) training and the acquisition of conditioned behavior was similar between the groups.

Following training, we performed optogenetic stimulation during fMRI measurements in both groups. Less-specific optogenetic stimulation in the fMRI resulted in activation in many cortical and subcortical areas, whereas the effects of specific stimulation were much weaker. Again, a D<sub>1,5</sub> receptor blocker applied during less-specific stimulation did not suppress the BOLD signal.

To exclude the effect of sedation during fMRI on neurovascular responses, the same animals were used in an awake SPECT study. SPECT data mostly supported fMRI results, revealing higher rCBF in NAcc and VTA in less-specific group, but not in the specific group.

In summary, our findings demonstrate that the effect of dopamine release on neurovascular signals is weak. It cannot explain canonical BOLD signals as they are commonly observed in human participants during rewarding experiences. Rather, the magnitude of the found dopamine-related signals might be better explained by a direct vascular effect of dopamine. Canonical BOLD signals might instead be elicited by glutamatergic activity which is correlated to mesolimbic dopamine release.

## Zusammenfassung

Die anatomischen Strukturen des mesolimbischen Dopaminsystems, wie die VTA, wurden bereits ausgiebig erforscht. Trotzdem ist wenig darüber bekannt, in welchem Umfang neuronale Aktivität in diesem Areal mittels bildgebenden Verfahren der neurovaskulären Kopplung, wie zum Beispiel fMRT und SPECT, visualisiert werden kann. Deshalb möchten wir untersuchen, ob unterschiedliche Varianten der VTA-Stimulation funktionelle Netzwerkaktivitäten im Gehirn auslösen. Die verwendeten Stimulationen unterscheiden sich dabei in ihrer Zellspezifität für Dopamin.

Um den Einfluss nicht-selektiver Stimulation auf VTA Neurone mittels BOLD-Kontrast zu untersuchen, nutzten wir elektrische VTA-Stimulation während fMRT Bildgebung. Dabei beobachteten wir eine weiträumige Aktivierung in Belohnungsarealen wie PFC/ACC, VTA und NAcc. Überraschenderweise hat die Gabe eines  $D_{1,5}$  Rezeptorblockers diese Signale nicht inhibiert. Daraus schlussfolgern wir, dass diese Aktivierung nicht durch Dopaminausschüttung ausgelöst wurde.

Um den spezifischen Einfluss Dopamins auf mesolimbische neurovaskuläre Signale genauer zu erforschen, nutzten wir zwei unterschiedliche Varianten der optogenetischen VTA-Stimulation. Diese unterscheiden sich durch ihre Dopamin-Spezifität. In der weniger spezifischen Variante transduzierten wir Neurone in Wildtyp-Ratten mit einem Opsin (CaMKII $\alpha$  Promotor). In der Dopamin-spezifischen Variante wurden Th-Cre Ratten mit geflochten Opsinen transduziert. Dadurch konnte eine selektive Opsin-Expression in den Dopaminzellen erreicht werden. Alle Tiere wurden einem intrakraniellen Selbststimulationstraining (ICSS) unterzogen. Beide Gruppen zeigten vergleichbares Lernen des konditionierten Verhaltens. Nach dem Training wurde die optogenetische Stimulation während der fMRT Messungen in beiden Gruppen durchgeführt. Dabei zeigte die wenig spezifischere optogenetische Stimulation während des fMRT eine Aktivierung in vielen kortikalen und subkortikalen Arealen. Die Effekte der spezifischen Stimulationen waren hingegen wesentlich schwächer. Die Gabe eines  $D_{1,5}$  Rezeptorblockers während der weniger spezifischen Stimulation inhibierte den BOLD-Kontrast nicht.

Während einer wachen SPECT-Messung wurde untersucht, ob die Sedierung während des fMRT einen Effekt auf die neurovaskuläre Antwort hatte. Die SPECT Daten bestätigen die Erkenntnisse aus dem fMRT. Der regionale zerebrale Blutfluss (rCBF) war höher im NAcc und der VTA in der weniger spezifischen stimulierten Gruppe, jedoch nicht in der spezifischen Gruppe.

Zusammenfassend zeigen unsere Daten, dass der Effekt von Dopamin auf die neurovaskuläre Antwort nur gering ist. Allgemein anerkannte BOLD-Kontraste, die bei menschlichen Probanden während einer Belohnungserfahrung auftreten, können damit nicht erklärt werden.

Vielmehr könnte ein direkter vaskulärer Effekt den Umfang der Dopamin-abhängigen Signale erklären. Die gemessenen BOLD Kontraste könnten stattdessen durch eine glutamaterge Aktivität, welche mit mesolimbischer Dopaminfreisetzung korreliert, hervorgerufen werden.

# 1. Introduction

## 1.1 VTA and dopamine

### 1.1.1 Anatomy, cell types and connections

The ventral tegmental area (VTA) is a dopaminergic nucleus in the midbrain. In rodents it is more easily distinguishable from substantia nigra (SN) than in primates, where sometimes these two regions are treated as one (VTA/SN; Düzel et al., 2009). The VTA is divided into different subregions. According to Aransay et al. (2015), one can distinguish up to eight nuclei included into VTA: parabrachial pigmented, paranigral, parainterfascicular, rostral ventral tegmental area, ventral tegmental tail (VTT), interfascicular, rostral linear, caudal linear. From the research on rodents it is known that there are three major types of cells in the VTA: dopaminergic (>60%), GABAergic (ca. 35%) and glutamatergic (ca. 2-3%) (Nair-Roberts et al., 2008). This distinction though is not very precise, since it is known that some of the cells can release both glutamate and dopamine (DA) or GABA and dopamine (Barker et al., 2016; Stuber et al., 2010; Tritsch et al., 2014) or even glutamate and GABA (Ntamati and Lüscher, 2016; Yoo et al., 2016). Projections from the VTA-DA neurons target many anterior cortical areas, nucleus accumbens, amygdala and dorsal striatum (Beier et al., 2015). Dopamine projections to nucleus accumbens and prefrontal cortex are called mesolimbic and mesocortical pathways, respectively. Many brain structures send their projections into the VTA DA neurons, including dorsal raphe, dorsal striatum, anterior cortex, lateral habenula, nucleus accumbens, ventral pallidum, zona incerta, laterodorsal tegmental nucleus etc. (Beier et al., 2015; Steidl et al., 2016).

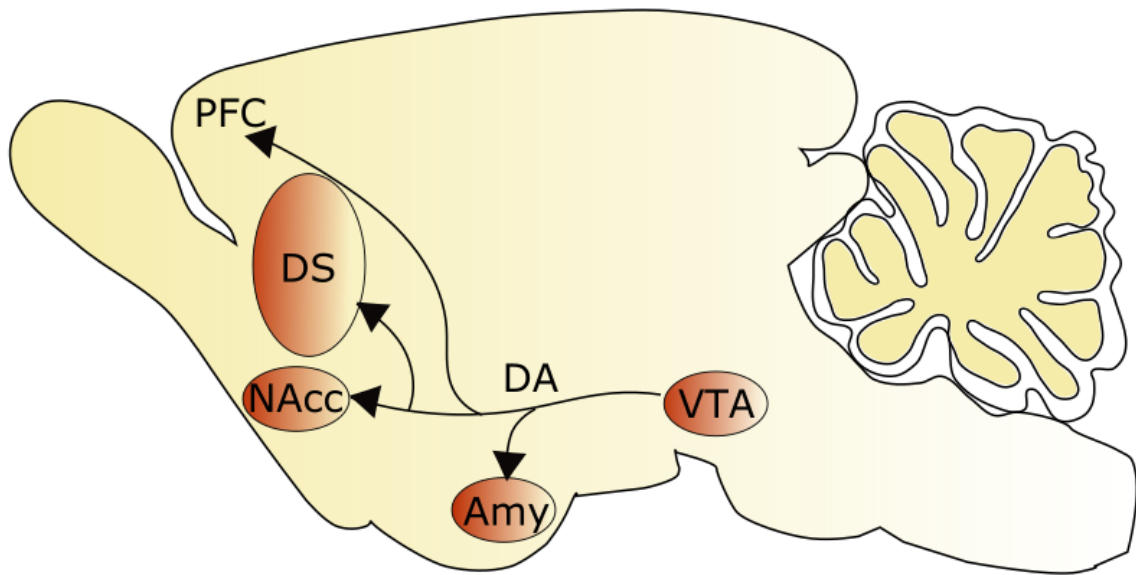

Figure 1. Main dopaminergic projections from the VTA (Amy- amygdala, NAcc- nucleus accumbens, DS- dorsal striatum, PFC- prefrontal cortex).

Dopamine is the main neurotransmitter associated with the VTA and its functions are comparatively well known. A number of recent publications focused, however, also on GABAergic and glutamatergic VTA cells. Glutamatergic cells, expressing vesicular glutamate transporter 2, establish local synapses (Dobi et al., 2010) or project to the nucleus accumbens, lateral habenula, ventral pallidum, and amygdala (Hnasko et al., 2012). They receive inputs from the lateral hypothalamus, raphe, ventral pallidum and cortex (Faget et al., 2016). It has been observed that glutamatergic neurons projecting to NAcc drive aversion (Qi et al., 2016), although according to another report, activity of glutamatergic cells has an appetitive value (Yoo et al., 2016).

Local GABA interneurons inhibit the firing of DA VTA cells, which leads to aversive behavior (Tan et al., 2012) and disrupts reward consumption (van Zessen et al., 2012). Main inputs to GABA-VTA cells are coming from medium-size spiny neurons of NAcc (Xia et al., 2011) and are inhibitory. The GABA projection neurons target NAcc, dorsal striatum (van Zessen et al., 2012), lateral and magnocellular preoptic nuclei, ventral pallidum, lateral hypothalamus, central amygdala, mediodorsal thalamus, lateral habenula, dorsal raphe, deep mesencephalic nuclei and prefrontal cortex (Taylor et al., 2014). Projections to NAcc do not seem to have an effect on neither aversion nor consummatory behavior, but enhance associative learning (Creed et al., 2014).

VTA cells co-releasing glutamate and GABA send their projections to dentate gyrus (Ntamati and Lüscher, 2016), ventral pallidum and lateral habenula (Yoo et al., 2016).

### 1.1.2 Dopaminergic receptors

There are two main families of dopaminergic receptors: The D<sub>1</sub> and D<sub>2</sub>. D<sub>1</sub> and D<sub>5</sub> receptor subtypes belong to the D<sub>1</sub> receptor family and the D<sub>2</sub>, D<sub>3</sub> and D<sub>4</sub> subtypes are part of the D<sub>2</sub> receptor family. All of them are G-protein coupled (Beaulieu and Gainetdinov, 2011). Activation of D<sub>1</sub> receptors results in increase of intracellular cAMP, whereas the activation of the D<sub>2</sub> receptors has an opposite effect (decrease of cAMP by adenylyl cyclase blockade), although some other cAMP-independent mechanism may also occur. The D<sub>1</sub> receptors are located at the postsynaptic side and D<sub>2</sub> receptors may be found on both pre- and postsynapse. Activation of presynaptic D<sub>2</sub> receptors (autoreceptors) inhibits the dopamine release from the cells. The recruitment of either of both dopamine receptor families during tonic and phasic dopamine release is still disputed (Dreyer et al., 2010; Trantham-Davidson, 2004), and probably depends on the investigated region (Dreyer, Haunsgaard, 2013) and on the techniques used.

### 1.1.3 Reward prediction error theory

The VTA and its connections are an important part of the reward system in the brain and play a significant role in cognitive functions like learning, motivation and addiction. A behavior which precedes the release of the DA from the VTA is more likely to be repeated. This effect can be observed in the case of intracranial self-stimulation in animals or drug abuse in humans. Furthermore, DA plays a major role in creating the neuronal connection between cue and reward. According to the theory of reward prediction error, DA neurons change their firing rate bidirectionally if a reward is larger or smaller than expected (Schulz et al., 1997). It was shown that optogenetic phasic activation (20Hz) of the VTA DA neurons can be treated as positive prediction error, because it facilitates cue-reward learning and attenuates the extinction of previously learned association (Steinberg et al, 2013). On the other hand, the short optogenetic inhibition of these neurons reflects negative prediction error (Chang et al., 2015).

### 1.1.4 Electrophysiological properties

There is some confusion in the literature concerning the electrophysiological properties of the VTA dopaminergic neurons. First studies, which also characterized the electrophysiological profile of DA cells, were done mostly on nigrostriatal neurons (Grace and Bunney, 1983) and results from these experiments were widely used to identify VTA-DA neurons (e.g. Floresco et. al, 2001). However, the established identification criteria were very questionable and needed to be updated (Ungless et al., 2004; Ungless and Grace, 2012). Nonetheless, it is

generally assumed that VTA DA neurons have three modes of activity: 1) tonic, less than 10 Hz (Floresco et al., 2001; Floresco et al., 2003; Roeper, 2013; Ungless and Grace, 2012), 2) phasic bursting, signaling the occurrence of salient, mostly rewarding event (Mirenowicz and Schultz, 1996) and 3) depression of activity, connected to omission of reward (Schulz et al., 1993) or to aversive stimuli (Mirenowicz and Schultz, 1996; Ungless et al., 2004).

It was shown that phasic, but not tonic, optogenetic stimulation of the VTA can cause place preference in studied animals (Tsai et al., 2009). Moreover, phasic stimulation is important for the acquisition of ICSS (intracranial self-stimulation) behavior (Ilango et al., 2014a; Beier et al., 2015).

#### 1.1.5 Intracranial self-stimulation (ICSS)

First observed by Olds and Milner (Olds and Milner, 1954), intracranial self-stimulation (ICSS) is a direct stimulation of brain areas, connected to the reward network, by the stimulated animal itself. ICSS leads to brain stimulation reward (BSR; Carlezon and Chartoff, 2007) and works as an operant reinforcer. The reinforced behavior has a form of e.g. nose poking, lever pressing or turning a wheel (Schulteis, 2010). Rewarding effect is achieved by means of chemical (sometimes also called self-administration; Schulteis, 2010), electrical, and optogenetic stimulation. There are several regions, which can be targets for ICSS, e.g. NAcc, substantia nigra, median forebrain bundle, PFC and VTA (Hsu et al., 2014; Ilango et al., 2014a and 2014b; Schenk et al., 1985; Wise, 1996). Optogenetic studies performed in the past few years identified several pathways and neurotransmitters engaged in ICSS (Britt et al., 2012; Gigante et al., 2016; Ilango et al., 2014a; Liu et al., 2014; Prado et al., 2016; Rossi et al., 2013; Steinberg et al., 2014; Witten et al., 2011). Optogenetic stimulation of glutamatergic inputs into NAcc (Britt et al., 2012; Prado et al., 2016) and dopaminergic cells from VTA (Ilango et al., 2014a and 2014b; Witten et al., 2011) and SNc (Ilango et al., 2014b; Rossi et al., 2013) leads to acquisition of self-stimulation behavior. Blockade of dopaminergic input to the NAcc attenuates the operant behavior (Beier et al., 2015; Steinberg et al., 2014). Moreover, glutamate co-release from DA cells does not appear to significantly influence the acquisition of ICSS (Wang et al., 2017). Therefore, the acquisition of ICSS behavior, through the stimulation of dopaminergic cells in the VTA, can be treated as an indirect evidence of dopamine release from the VTA.

## 1.2 Optogenetics

### 1.2.1 Optogenetics to study the role of dopaminergic network

Many studies on the role of the DA are based on the effects of electrical stimulation or pharmacological modulations. Those methods have some clear limitations. Electrical stimulation reaches not only the dopaminergic cells, but all the cells in a stimulated region (in case of VTA also GABA- and glutamatergic neurons). Moreover, it stimulates passing axons and differentially affects all of these components depending on their size and geometry in relation to the electrodes (Ranck, 1975). Pharmacological manipulation is a more precise tool since it is able to block or mimic the effects of the transmitter release. However, the temporal resolution of such a manipulation (minutes, hours) does not allow observing short-term effects of reward-related phasic dopaminergic activity. In addition, unless injected locally, it acts in all cells which carry a certain receptor and therefore often lacks regional specificity.

Optogenetics can overcome some of these limitations. With millisecond precision, light drives excitation or inhibition of neuronal cells through light gated channels, so-called opsins. Use of transgenic animals allows for precise targeting of subset of neuronal cells in a particular structure, such as dopaminergic VTA neurons. All these features mark out optogenetics as a technique of high spatial and temporal resolution.

### 1.2.2 Animal models used in optogenetic studies

In the current study, we used two animal models of different dopamine specificity to compare the effects of stimulation of different subpopulations of VTA cells. Two rat models were used to either target 1) dopaminergic cells, 2) a mixed population of VTA neurons.

We achieved specific targeting of dopaminergic VTA neurons by using Th-Cre rats. Cre recombinase is an enzyme which recognizes two specific sites on DNA (loxP sites) and catalyzes recombination of these two sites. Depending on the orientation of loxP sites, the DNA between them (called "floxed DNA") can be either cut out or inverted (Nagy, 2000). In Th-Cre animals, Cre recombinase is expressed in the cells in which transcription of tyrosine hydroxylase (Th) takes place (Witten et al., 2011). Th is an important enzyme in the metabolic pathway of dopamine synthesis and anti-Th immunohistochemistry is usually used to detect dopaminergic cells. To induce expression of an opsin in Th cells, the DNA construct encoding promoter, opsin, marker, loxP sites and other supporting sequences is encapsulated in the viral vector and injected in close proximity of dopaminergic cells. AAV and lentiviral vectors are mostly used for this purpose. The AAV vector stays outside of the chromosomes or builds into the specific place in the genome. On the other hand, the lentiviral vector integrates into



the genome randomly, unless it is integrase deficient (Parr-Brownlie et al., 2015). Only in the cells with Cre recombinase, floxed DNA is inverted, functional opsins can be produced and transported to the cell membrane. Cre expression in Th-Cre mice is not, however, limited to DA cells, which does not seem to be an issue concerning Th-Cre rats (Pinto and Lammel, 2017). Therefore, good validations of existing models are important to draw accurate conclusions from optogenetic studies.

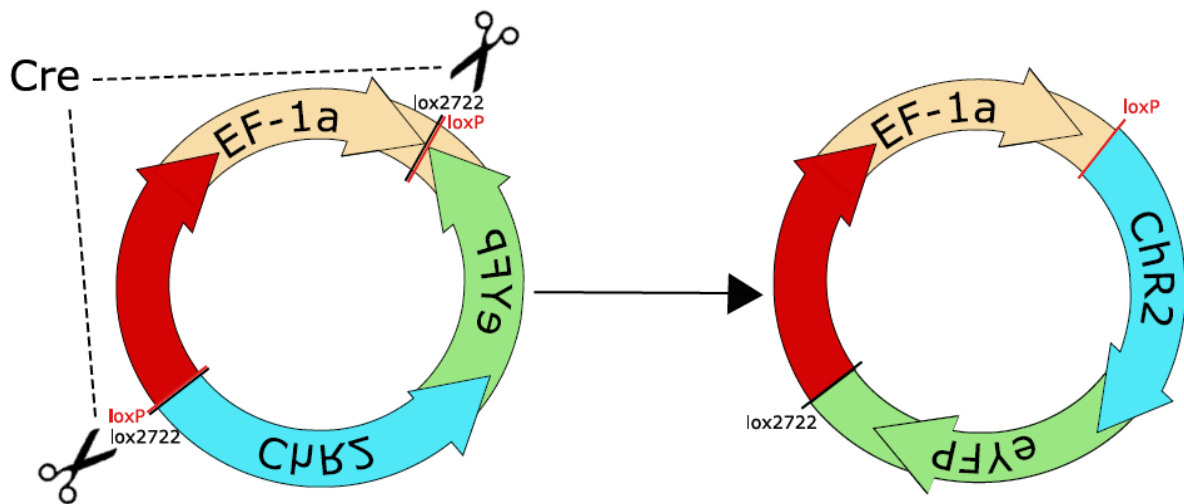

Figure 2. Expression of the functional opsin construct depends on the presence of Cre recombinase in the cell. Cre recombinase recognises loxP sites and inverts the DNA between them.

To target a mixed population of VTA neurons (less-specific), we used wild-type (WT) littermates of Th-Cre rats and injected the viral construct with CaMKII $\alpha$  promoter. An opsin under the CaMKII $\alpha$  promoter, used in the less-specific paradigm, is expressed in dopaminergic cells, but also glutamatergic cells (Liu and Jones, 1996; Sik et al., 1998) and potentially even in inhibitory neurons (Cook-Snyder et al., 2015; Jennings et al., 2013; Johansen et al., 2010; Nieh et al., 2015).

The use of dopamine-specific and less-specific models in the current study allows for the evaluation of the neurovascular responses caused by the activation of different neuronal groups in the VTA.

## 1.3 Functional neuroimaging

### 1.3.1 Neurovascular coupling

Neurovascular coupling is a relationship between the regional neuronal activity and vascular changes in the brain (Huneau et al., 2015; Pasley and Freeman, 2008). Local neuronal activity leads to higher energy consumption (neurometabolic coupling). Energy in living organisms is stored in form of ATP, produced mainly during glucose- and oxygen-dependent aerobic respiration. The need of increased glucose- and oxygen-transport towards active brain areas leads to increase of regional cerebral blood flow (Pasley and Freeman, 2008).

There are several imaging techniques based on measuring the cerebral blood flow (CBF), therefore it is crucial to understand the mechanism of neurovascular coupling to correctly interpret the neuroimaging data. The CBF-sensitive techniques include laser Doppler and laser Speckle flowmetry (in animal models), functional magnetic resonance imaging (fMRI), near infrared spectroscopy (NIRS), positron emission tomography (PET), and single-photon emission computed tomography (SPECT; Huneau et al., 2015; Kolodziej, et al., 2014).

The most comprehensive research on neurovascular coupling was performed with fMRI BOLD.

### 1.3.2 The BOLD signal and neurovascular coupling

One source of the signal in the fMRI (functional magnetic resonance imaging) is the BOLD (blood oxygenation level dependent) contrast. Brain activation causes a rise in the concentration of CBF and oxy-hemoglobin (HbO) in activated areas. Oxygen delivery is higher than oxygen consumption and due to the diamagnetism of HbO, the MRI-signal is affected (Ogawa et al., 1991).

How exactly different types of neuronal activity and BOLD signal are related, is still partially unclear (Attwell & Iadecola, 2002; Ekstrom, 2010; Lippert et al., 2010; Nir et al., 2008; O'Herron et al, 2016). Neuronal activity can be defined as: 1) local field potentials (LFPs), reflecting the synaptic/dendrosomatic/input processes and 2) spikes (action potentials), connected to axonal/output signaling (Pasley and Freeman, 2008). Naturally, these two types of activity are often highly correlated. That leads to the situation when both of them can be a good predictor of BOLD (Smith et al., 2002). However, under some circumstances, the dissociation between spikes and LFPs may occur. According to many studies, in which neuronal responses connected to sensory input were measured, BOLD response reflects better LFPs than action potentials (Lippert et al., 2010, Logothetis et al., 2001; Pasley and

Freeman, 2008). In addition, an optogenetic study (Iordanova et al., 2015), in which not only sensory input but also direct optogenetic stimulation of cells was used, supported this findings, although it is furthermore possible that these both stimulation modalities drive a BOLD response based on different types of neuronal activity (Scott and Murphy, 2012). Nonetheless, more detailed investigation revealed partial decoupling between neuronal activity (both synaptic transmission and action potentials) and hemodynamic reaction (O'Herron et al, 2016).

Some optogenetic studies did not support the simple conclusion of the match between LFPs and BOLD (Ji et al., 2012; Kahn et al., 2013; Lee et al., 2010). Kahn and colleagues (2013), who instead of sensory input used direct optogenetic stimulation of cells, showed a stronger correlation between action potentials and BOLD response than between LFPs and BOLD. Another study demonstrated that depending on the length of the stimulus either LFPs or spikes can be better predictors of BOLD signal changes (Ji et al., 2012). Moreover, it was shown that BOLD response is not an exact reflection of neuronal activity but even exceeds it, although the extent of BOLD response is proportional to the number of activated neurons (Christie et al., 2017).

It is important to remember that the activity of inhibitory neurons may lead to higher energy consumption (Buzsáki et al., 2007) and either decrease or increase of the BOLD signal (Angenstein et al., 2009; Lee et al., 2010; Logothetis, 2008), which also demonstrates the very complex relationship between BOLD and neuronal activity. Neurovascular and neurometabolic coupling depend, among others, on the age of subjects (Kozberg et al., 2016) and on the presence or absence of brain pathologies, such as Alzheimer disease or stroke (Iadecola, 2004). The BOLD signal can be also influenced by various anesthetics used during the fMRI measurement (Krautwald and Angenstein, 2011), the concentration of respiratory gases in the blood under different physiological condition (Cohen, Ugurbil, Kim, 2002) and adaptation mechanisms (Sander et al., 2016). Moreover, different distribution of various neurotransmitter receptors in different species can lead to varied results from fMRI experiments, making it very hard to compare the results between species, although such attempts have been undertaken (Mandeville et al., 2013).

#### 1.3.2.1 Effects of dopamine release on BOLD signal

Taking all problems mentioned before into consideration, it is rather difficult to assess the effect of a single neurotransmitter like dopamine on BOLD response. There were, however, several attempts to investigate this issue. For this purpose, in numerous studies dopamine agonists, antagonists (Shih, 2009), addictive drugs like amphetamine and cocaine (Chen et al, 1997;

Febo et al., 2004; Marota et al., 2000), dopamine sensors (Lee et al., 2014), electrical (Arsenault et al., 2014; Helbing et al., 2016; Settell et al., 2017), chemogenetic (Roelofs et al., 2017) and optogenetic (Decot et al., 2016; Ferenczi et al., 2016; Helbing et al., 2016; Lohani et al., 2016) stimulation, special reward-related cognitive tasks (Alves, 2009; D'Ardenne, 2008) and fMRI combined with PET (Ghahremani et al., 2012; Schott et al., 2008; Urban et al., 2011) were used. In the majority of studies, correlation between DA release and BOLD signal was reported. In their review from 2007, Knutson and Gibbs proposed that the dopamine release leads to an increase of BOLD signal in NAcc via D<sub>1</sub> receptors. However, a study of Choi et al. (2006) showed that the BOLD changes coupled with dopamine release cannot be exclusively explained by neuronal activity but can be associated with the expression of dopamine receptors on microvessels and astroglia. It has also been suggested that a change in BOLD signal, traditionally related to dopamine release, may in some cases be driven by glutamate (Urban et al., 2011). According to newer optogenetic research (Ferenczi et al., 2016; Lohani et al., 2016), dopamine release from the VTA increases the BOLD response mostly in striatum (both dorsal and ventral).

#### 1.3.2.2 Considerations when combining fMRI and optogenetics

The combination of optogenetics and fMRI already appeared in a number of studies published so far. The specificity of the stimulation and the well-known mechanism and time of action are major advantages of this technique. As previously mentioned, optogenetic fMRI studies capitalize, for example, on neurovascular coupling (Christie et al., 2017; Ji et al., 2012; Kahn et al., 2013; Lee et al., 2010; Scott and Murphy, 2012) and on the connection between dopamine release and the BOLD signal (Helbing et al., 2016; Decot et al., 2016; Ferenczi et al., 2016; Lohani et al., 2016). Apart from the obvious advantages of combining these two methods, one should also keep in mind that the light itself can influence the BOLD signal (Christie et al., 2013 & 2017; Pawela et al., 2013; Rungta et al., 2017; Schmid, et al., 2017). Light-driven BOLD response may be connected to:

- 1) activation of visual pathways (Ferenczi et al., 2016; Pawela et al., 2007; Schmid, et al., 2017), which apparently can be eliminated by low-level constant illumination to the eyes (Schmid, et al., 2017),
- 2) vasodilatation occurring even in absence of any neuronal activity (Rungta et al., 2017),
- 3) heating of the tissue (Christie et al., 2013).

Light artifacts are visible especially during application of trains of multiple light pulses (Christie et al., 2017). For this reason, adequate controls (e.g. use of animals which are not expressing opsins) are very important.

### 1.3.3 <sup>99m</sup>Tc-HMPAO-SPECT

One of main drawbacks of fMRI is that the animals have to be either sedated or immobilized, which in itself can affect the state of dopaminergic network. During the tracer infusion for SPECT (single photon emission computed tomography), animals can be awake and move freely, which is a major advantage over fMRI.

The source of the signal in SPECT imaging is the change in regional cerebral blood flow (rCBF) upon the activation of a particular area. <sup>99m</sup>Tc-HMPAO-SPECT therefore relies on a very similar process, the increase in perfusion in activated brain regions, but, unlike fMRI, it measures blood flow instead of oxygenation. In a typical experiment, the subject is injected with the radioactive tracer <sup>99m</sup>Tc-HMPAO (technetium (<sup>99m</sup>Tc) hexamethyl-propyleneamine oxime). This tracer crosses the blood-brain barrier in a rCBF-dependent concentration. After crossing the barrier, the lipophilic complex disintegrates, trapping the radioactive technetium in the brain. Due to the ion's charge, it remains trapped in the extracellular space for hours. A gamma radiation sensitive pinhole-camera can then be used later to image the distribution of the radioactive tracer inside the brain (Meikle et al., 2005). The direct combination of SPECT and CT (computer tomography) allows for an anatomical localization of measured functional signal without distortions induced by magnetic inhomogeneities (Buck et al., 2008). A map of tracer accumulation is required afterwards and for that purpose the animal needs to be immobilized/anesthetized. Therefore, SPECT is characterized by low temporal resolution, since only "frozen" patterns of tracer distribution can be acquired. That means that for every stimulation session or behavioral condition, one image of the whole brain is obtained. It is required that the consecutive scans of one subject should take place with about 48 hours inter-scan interval for radioactive decay to occur.

#### 1.3.3.1 SPECT imaging and dopamine release from the VTA

The work by Kolodziej and colleagues from 2014 has been the only study published so far concerning optogenetic VTA stimulation and small-animal SPECT. In this study, the activations from electrical and optogenetic stimulation in mice were compared. Optogenetic stimulation was, however, not dopamine-specific since WT animals were used and vector construct was expressed in a mixed set of the VTA neurons under the CaMKII $\alpha$  promoter.

## 2. Aims of the study

The influence of dopamine and other neurotransmitters released from the VTA on neurovascular effects on the whole-brain level are not well known. Therefore, in the current study we combined neuroimaging and different methods of VTA stimulation (optogenetic and electrical) to investigate this issue. Use of both neuroimaging techniques (SPECT and fMRI) made it possible to compare the effects of the optogenetic stimulation in awake and sedated state. Furthermore, we explored the differences between the optogenetic stimulation of mixed population of VTA neurons (less-specific) and exclusive stimulation of dopaminergic neurons (dopamine specific) to determine the contribution of dopamine and other neurotransmitters in ICSS acquisition and neurovascular response.

## 3. Materials and methods

Parts of this section have already been published in Helbing et al., 2016 or are included in Brocka et al. 2018.

### 3.1 Subjects

Rats were housed under standard laboratory conditions (constant temperature, 12:12 h light/dark cycle, food and tap water *ad libidum*). Both transgenic Th-Cre rats and their non-transgenic littermates (Long Evans-Tg(Th::Cre), Deis; Witten et al., 2011) were used in the optogenetic experiments. Electrical stimulation data was acquired in Wistar rats. The experiments were performed in compliance with the EU Directive 2010/63/EU for animal experiments and approved by the local ethical committee.

### 3.2 Viral vectors and stereotactic surgery

The following types of viral vectors were used: AAV2/5-CamKII $\alpha$ -C1V1(E162T)-p2A-EYFP (Prakash et al., 2012) for wild type (WT) animals, AAV2/5-Ef1 $\alpha$ -DIO-hChR2(H134R)-eYFP-WPRE-pA for Th-Cre rats and AAV2/5-CaMKII $\alpha$ -EYFP for WT controls. The CamKII $\alpha$ -promoter targets a mixed population of the VTA neurons, which are predominantly, but not exclusively, dopaminergic. In transgenic animals, selectivity is provided by the expression of Cre-recombinase under the Th-promoter, which is exceptionally specific in the rat strain used (Witten et al., 2011). The two different opsins were used due to their ability to match self-stimulation rates across groups. Viral solutions were kindly provided by Karl Deisseroth through the Viral Vector Core of the University of North Carolina.

For virus injection and optical fiber implantation, the rats were anesthetized with pentobarbital (50mg/kg) and fixed in a robotic stereotactic instrument (Neurostar). Two injections of 650 nl viral solution ( $2 \times 10^{12}$  gc/ml) each were conducted in the VTA (-5.8 mm AP, -0.7 mm ML, 7.2 mm for the first injection and 7.6 mm for the second injection DV, speed 100 nl/min, 5-10 min rest after injection). A custom-made optical fiber (200  $\mu$ m core diameter, N.A. 0.39) was implanted above the injection sites (6.8 mm DV). Rats were given at least three weeks to recover and to express the virus.

### 3.3 Implantation of the electrodes

Rats were deeply anesthetized with pentobarbital (40 mg/kg, i.p.) and placed in a stereotactic frame. For electrical stimulation of the VTA, a bipolar stimulation electrode was implanted into the VTA (coordinates: AP -5.6 mm, ML +2.3 mm from Bregma, DV 7.8 mm from dural surface angled 10° to the midline). Following surgery, animals were provided with *ad libitum* food and water and housed individually for a recovery period of 1 week.

### 3.4 ICSS

To confirm the correct fiber placement, animals were trained in an intracranial self-stimulation (ICSS) paradigm for 10 consecutive days (30 min/day). Upon pressing the nosepoke lever, the rat received a brief train of laser light pulses (10 pulses, 25 Hz, 10 ms pulse width, 10 mW at the tip of the fiber; less-specific stimulation: 532 nm, specific stimulation: 473 nm). Animals that did not reach 400 presses per session after 10 days were not used further in the study.

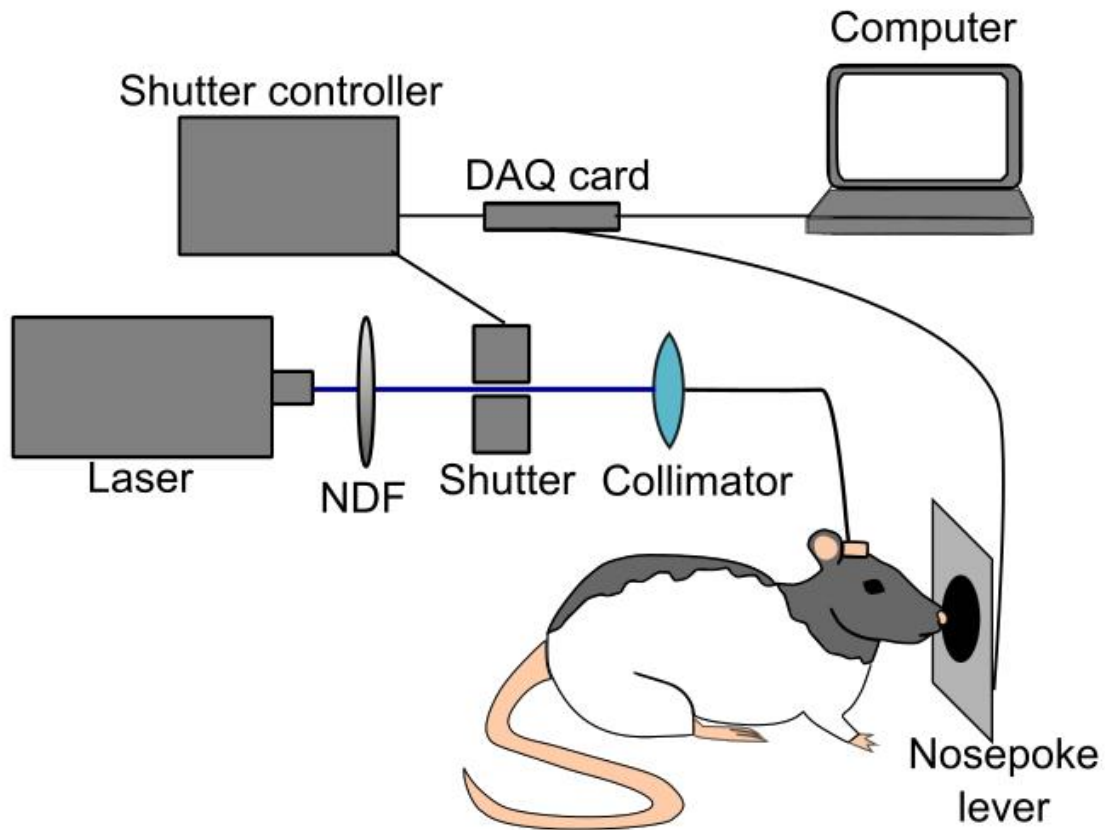

Figure 3. Self-stimulation setup. The rat is placed in the self-stimulation box with an active nose-poke lever. Upon pressing the lever, the shutter opens and the animal receives brief laser light stimulation. The shutter controller is controlled by the LabView® program. Neutral density filter (NDF) is used to adjust the light intensity to 10 mW at the end of the optical fiber. Adapted from Brocka et al. (2018)

### 3.5 fMRI

MRI measurements were performed in combination with optogenetic or electrical stimulation of the VTA. Rats were initially anesthetized with isoflurane (1.5%; in 50:50 N<sub>2</sub>:O<sub>2</sub>; v:v) and fixed into the head holder. Depending on the experiment, they were either connected to recording and stimulation electrodes (electrical stimulation) or to the optical cable (optogenetic stimulation). The anesthesia was switched to deep sedation by application of medetomidine (Dorbene, Pfizer GmbH, bolus: 50 µg/kg s.c. and after 15 min 100 µg/kg per h s.c.; Weber et al., 2006). Breathing, heart rate and oxygen saturation were monitored throughout the experiment by an MRI-compatible pulse oxymeter (MouseOX™; Starr Life Sciences Corp., Pittsburgh, PA, USA). Heating was provided from the ventral site.

All fMRI measurements were performed on a 4.7 T Bruker Biospec 47/20 animal scanner (free bore of 20cm) equipped with BGA09 (400 mT/m) gradient system (Bruker BioSpin GmbH, Ettlingen, Germany. A 50 mm Litzcage small animal imaging system (DotyScientific Inc., Columbus, SC, USA) was used for the RF signal reception.



Anatomical images were obtained with the following parameters: 10 horizontal  $T_2$ -weighted spin-echo images, RARE sequence: TR 4000 ms, TE 15 ms, slice thickness 0.8 mm, FOV 37x37 mm, matrix 256x256, RARE factor 8, number of averages 4. The total scanning time was 8 min 32 s. Functional MRI (fMRI) was performed using a gradient-echo EPI (echo planar imaging) sequence with the following parameters: TR 2000 ms, TE 24 ms, The slice geometry, i.e., ten horizontal slices, was identical to the previously obtained anatomical spin-echo images.

### 3.6 Optogenetic stimulation

Every stimulation protocol was preceded by 2 min baseline acquisition, during which no stimulation was applied. We used the same fMRI optical stimulation protocol as previously described (Helbing et al., 2016). Briefly, it consists of 8 bursts of light (10 pulses, 25 Hz, 10 ms, 10 mW, 532 nm in case of less-specific stimulation, 473 nm in case of specific stimulation and EYFP control rats), spaced one second apart and followed by 52 s of rest. This sequence was repeated 15 times for each animal. Total scanning time was therefore 17 min. In Study I, seven animals for less-specific stimulation and seven for specific stimulation were used. In Study II, the measurements were done on eleven less-specifically stimulated, ten specifically stimulated and two WT controls. During the fMRI measurements for Study II the eyes of the animals were covered with a piece of black foil to decrease the chances of visual artefacts.

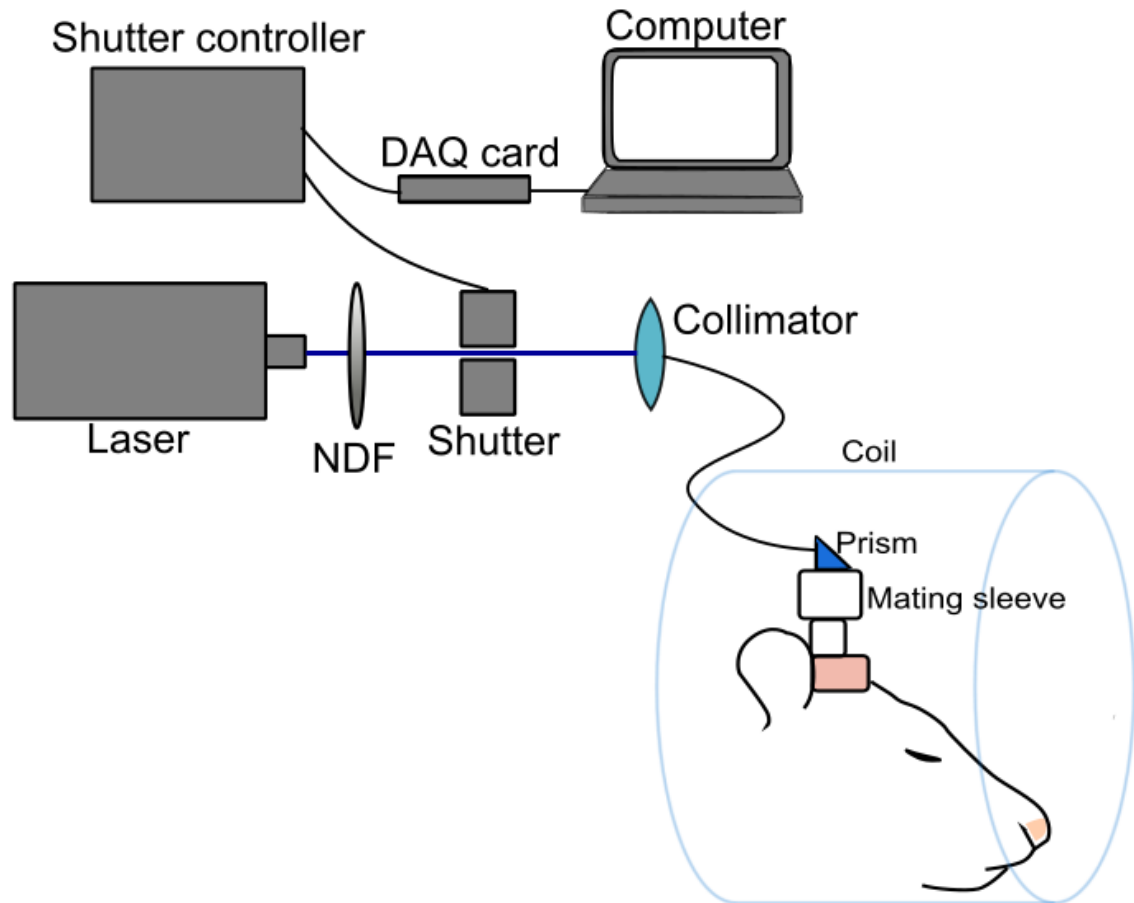

Figure 4. Setup for optogenetic stimulation in the fMRI. The sedated rat is placed in the fMRI scanner and light stimulation is controlled by the LabView® program. A custom-made light coupler, consisting of an optical cable, a prism, and a mating sleeve are used to deliver light to the optical fiber implanted in the brain. Adapted from Brocka et al. (2018)

### 3.6.1 Pharmacological manipulation: D<sub>1,5</sub> receptor blockade

For the D<sub>1,5</sub> receptor blockade experiments both Th-Cre (n=2) and WT rats (n=4) were used; all of the animals received the injections of AAV2/5-CamKII $\alpha$ -C1V1(E162T)-p2A-EYFP virus (less-specific stimulation) and underwent ICSS training. About 30 min before the fMRI/optogenetic stimulation session, the rats were injected with SCH23390 (0.2 mg/kg, i.p.) to test the role of the dopamine D<sub>1,5</sub> receptors in the formation of a BOLD response during less-specific stimulation.

### 3.7 Electrical stimulation

All animals were initially anesthetized with isoflurane (1.5–1.8%; in 50:50 N<sub>2</sub>:O<sub>2</sub>; v:v) and the anesthesia was switched to deep sedation by application of medetomidine (Dorbene, Pfizer

GmbH, bolus: 50 mg/kg s.c. and after 15 min 100 mg/kg per h s.c.) after animals were fixated to the head holder and connected to recording and stimulation electrodes.

During fMRI the VTA was stimulated with discontinuous 100 Hz pulses, i.e., 8 bursts of 10 pulses applied one burst per second. One stimulation train lasted 8 s, so during the one train, 80 identical pulses were applied. The applied stimulation protocol consisted of 10 consecutive stimulation trains, given every minute after the two-minute baseline. The pulse intensity for the VTA stimulation was set to 300  $\mu$ A, which did not cause stimulus-induced movements of the head. In each Study (I and II) seven rats underwent electrical stimulation in the fMRI.

### 3.7.1 Pharmacological manipulation: D<sub>1,5</sub> and NMDA receptor blockade

To test the role of the dopamine D<sub>1,5</sub> receptors in the formation of a BOLD response during electrical stimulation, the animals (n=7) received the dopamine D<sub>1,5</sub> receptor antagonist SCH23390. The combined fMRI and electrophysiological measurement started about 30 min after drug application. The role of N-methyl-D-aspartate (NMDA) receptor activation in the generated BOLD response was tested in an additional group of animals by application of the NMDA receptor antagonist MK801 (0.5 mg/kg, i.p.). MK801 was also applied immediately before the combined fMRI/electrophysiology session.

### 3.8 Data processing and analysis

The fMRI data were analyzed in BrainVoyager QX (Brain Innovation, Maastricht, the Netherlands). A standard sequence of pre-processing steps, including slice scan time correction, 3D motion correction (trilinear interpolation and reduced data using the first volume as reference) and temporal filtering (high pass GLM-Fourier: three sines/cosines and Gaussian filter; FWHM 3 data points) was applied to each data set. Images were reconstructed at 128  $\times$  128 voxels per slice and spatially smoothed (Gaussian filter of 1.4 voxel). Functional activation was analyzed by using the correlation of the observed BOLD signal intensity changes in each voxel with a predictor (hemodynamic response function, HRF), generated from the given stimulus protocol. To calculate the predictor, the square wave representing stimulus on- and off-conditions was convolved with a double gamma HRF (onset 0 s, time to response peak 5 s, time to undershoot peak 15 s). Based on this multi-subject GLM (general linear model) analysis, the appropriate activation map could be generated. All significantly activated voxels were converted into volumes of interest (VOI), from which surface clusters were created and visualized with the BrainVoyager VOI analysis tool. To exclude false

positive voxels in Study I, we only considered those with a significance level  $p$  of less than  $6.8 \times 10^{-7}$  ( $t_{\min}=5$ ) for analysis of the size of the activated area, which was thus clearly above the threshold set by calculating the false discovery rate (FDR) with a  $q$ -value of 0.05 (which corresponds to a  $t$  value greater than three or  $p < 0.005$ ).

To exclude false positive voxels in Study II, we only considered those with a significance level  $p$  above the threshold set by Bonferroni corrected  $p$  value of 0.001 (which corresponds to a  $t$  value greater than 5.6) or by an uncorrected  $p$  value of 0.01 (which corresponds to a  $t$  value greater than 3.2).

In Study II, a volume of interest (VOI) analysis was performed. Individual VOIs, i.e., right and left hippocampus, right and left nucleus accumbens, right and left striatum, septum, prefrontal cortex region and VTA were marked in the 3D standard rat brain. The average BOLD time series of all voxels located in one VOI was then calculated for each individual animal using the volume-of-interest-analysis tool implemented in the BrainVoyager QX2.6.1 software. Each individual BOLD time series was normalized using the averaged BOLD signal intensity as 100%. All normalized BOLD time series were then averaged and depicted as mean BOLD time series  $\pm$  SD. These mean BOLD time series of individual VOIs were used to calculate event related BOLD responses.

Event-related BOLD responses were calculated by measuring the signal intensities starting six frames before stimulus onset ( $-12$  s until  $0$  s), during stimulus presentation (between  $0$  and  $8$  s, which corresponds to four frames) and the following 15 frames ( $8$  s to  $38$  s) after the end of the stimulus. To avoid the confounding effect of putative variations in baseline BOLD signal intensities on the calculated BOLD response (i.e.  $\text{BOLD signal}_{\text{stimulus}}/\text{BOLD signal}_{\text{baseline}} \times 100\%$ ), each BOLD response was related to BOLD signal intensities of the stimulus over the preceding 12 s.

### 3.9 SPECT

Following fMRI scans, animals were implanted with a silicon catheter in the right external jugular vein (Gaudig Laborfachhandel GbR, Sülzetal-Osterwedding, Germany; OD: 1.3 mm, ID: 0.5 mm, catheter length 11 cm). Catheter lock solution (Cath-Loc HGS, SAI Infusion Technologies, USA) was injected into the catheter to prevent from clogging. The animals were given at least one day to recover from surgery before the SPECT measurements. Nine animals for dopamine-specific and nine for less-specific stimulation were used. For each animal, one baseline and one stimulation measurement were performed. Animals were awake during the injection of the radioactive tracer (250 MBq of  $^{99m}\text{Tc}$ -HMPAO in 400  $\mu\text{l}$  volume, for details see

Kolodziej et al., 2014 and Vincenz et al., 2017). In both stimulation conditions, animals were connected to the optical cable and could move freely in a plastic box.

The optical stimulation protocol was similar to the protocol used during fMRI but contained 10 instead of 15 repetitions following previous protocols (Kolodziej et al., 2014) with tracer-injection times of 10 min. After these 10 min, rats were anesthetized with isoflurane and scanned in a small-animal SPECT scanner (NanoSPECT/CT, Mediso, Hungary).

### 3.9.1 Data analysis

Images were reconstructed at an isotropic voxel size of 333  $\mu\text{m}$ . In addition to SPECT, CT scans (45 kVp, 177  $\mu\text{A}$ , 180 projections, 500 ms per projection) were acquired from the same FOV as SPECT-images and reconstructed at an isotropic voxel size of 200  $\mu\text{m}$ . SPECT/CT images were aligned to a rat brain MR-template using the MPI-Tool-Software (Advanced Tomo Vision, Germany). Alignments were based on the best fit of CT- and MR-images and all images were saved with 200  $\mu\text{m}$  isotropic voxel sizes. SPECT-brain data were manually segmented using a whole-brain VOI with Osirix.

SPECT data sets were intensity-normalized to the same global mean. For statistical analysis, voxel-wise paired t-tests were performed. The resulting *P*-maps were smoothed with a median filter using a 3x3x3 voxel kernel. Statistical analysis and smoothing were done with the Magnan-Software (version 2.4, BioCom GbR, Germany). In accordance with previous small-animal radionuclide imaging studies, uncorrected *P*-values are given (Endepols et al., 2010; Michaelides et al., 2013; Thanos et al., 2013). SPECT/MR fusion images were made in Osirix and arranged for illustration using Photoshop CS6 (Adobe Systems, San Jose, USA).

### 3.10 Fast-scan cyclic voltammetry (FSCV)

Rats were anaesthetized with urethane (1.6 g/kg i.p.) and placed in the stereotactic frame. A carbon fiber working electrode was lowered into the right NAcc (shell) (AP: +1.6 mm, ML: +2.2 mm from bregma, DV: 7.0-7.5 mm from the dural surface) and recording started 90 min after implantation of the electrode. The optogenetic stimulation protocol was similar to the one used during fMRI and SPECT (10 trains, 10 pulses, 25 Hz, 10 ms, 10 mW, 532 nm in case of less-specific stimulation, 473 nm in case of specific stimulation).

Fast-scan cyclic voltammetry (FSCV) was performed with polymer-encased carbon fiber electrodes (7  $\mu\text{m}$  diameter, ~ 100  $\mu\text{m}$  length; Toray Carbon Fibers America, Inc., Santa Ana, CA, USA) as an acute procedure. The Ag/AgCl reference electrode was prepared from silver wires (0.5 mm diameter, Sigma-Aldrich, St Louis, MO, USA) chloridized in 0.1 M HCl. All cyclic

voltammograms were obtained with a triangular waveform (scan rate: 10 Hz, resting potential: - 0.4 V, switching potential: 1.2 V, 400 V/s, 1000 samples per scan). Waveform generation and data collection were performed with the Invilog Voltammetric System and Software (Acquisition and Stimulation A&S, Invilog Research Ltd, Kuopio, Finland) and analyzed by a Fast Cyclic Voltammetry Analysis (FSV Analysis, Invilog Research Ltd, Kuopio, Finland) tool, which integrates FSCV and displays electrochemical measurements on a base station computer. The FSCV carbon fiber electrode was placed in the NAcc (AP: 1.6 mm, ML: 1.5 mm from bregma, DV: 6.6–7.5 mm from the dural surface).

Because of the inherent differences in sensitivity between Polymer-coated electrodes, *in vivo* changes in oxidation current recorded with different electrodes (in different animals) cannot be assumed to be equivalent. Thus, valid comparisons are possible only if the sensitivity of each electrode is calibrated against a standard and the electrochemical data are expressed as standard equivalent values. In the present study, DA was used as the standard to calibrate the working electrode sensitivity. Accordingly, *in vivo* changes in oxidation current are expressed as  $\mu\text{M}$  values of dopamine concentration. Therefore, the peak oxidation currents for dopamine in each voltammogram (at approximately 0.6 V) were converted into concentration from a post-experiment calibration against fresh solutions of 0.1 to 2  $\mu\text{M}$  dopamine.

### 3.11 Histology

Rats were perfused transcardially with a 4% paraformaldehyde solution and the brain was sectioned on a vibratome or cryotome. Fiber placement and viral expression were confirmed under a confocal microscope. Primary antibody against tyrosine hydroxylase (1:1000 rabbit anti-Th, Millipore Corporation, Billerica, USA) and fluorescent (Alexa 546, Molecular Probes, Eugene, USA) secondary anti-rabbit antibody were used to stain for dopaminergic cells.

## 4. Results

### 4.1 Study I

In this study, we investigated if/to what extent is dopamine responsible for formation of canonical, reward-related BOLD response.

#### 4.1.1 Evoked BOLD signal depends on cell-specificity of VTA stimulation

In our first study (Helbing et al., 2016), we used 25 Hz phasic less-specific and specific optogenetic stimulation and compared the evoked BOLD signals. We observed clear BOLD responses upon less-specific stimulation which covered e.g. VTA, NAcc, and prefrontal cortex. However, during specific stimulation, we saw only a slight increase in signal in the tectum.

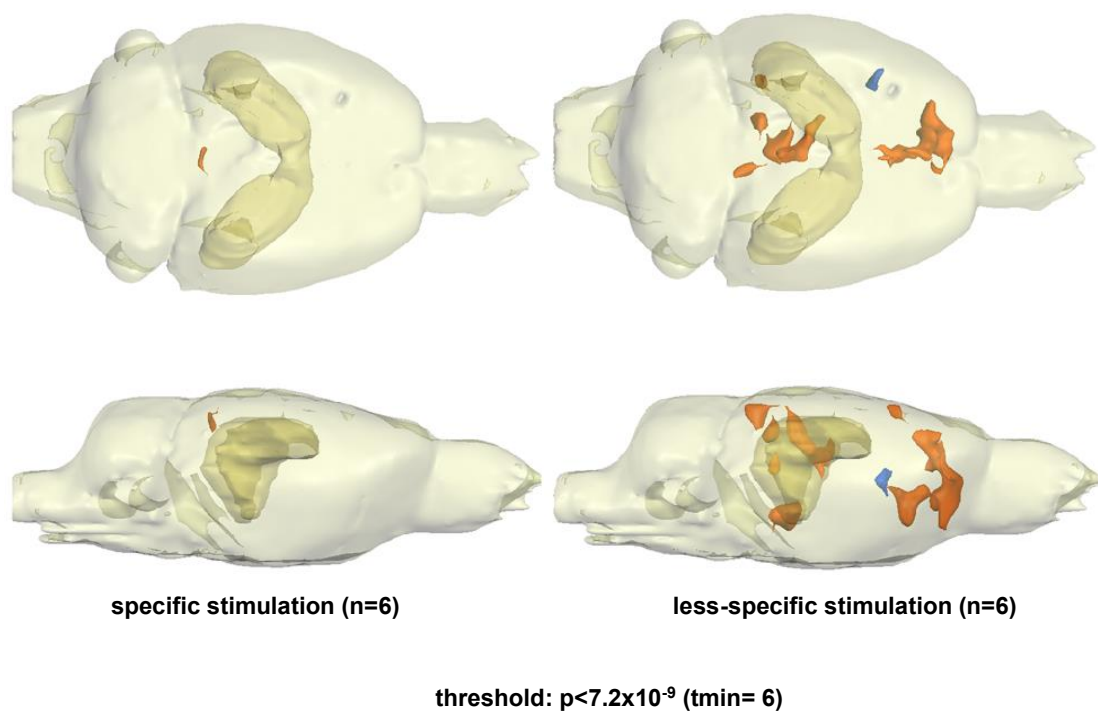

Figure 5. BOLD signals evoked by less-specific and specific optogenetic stimulation. Adapted from Helbing et al., 2016.

Electrical stimulation was for many decades the main technique used to non-specifically modify the activity of neurons. To put our results in context of these classical experiments, we decided to compare the optogenetic stimulation of the VTA with the electrical one (100 Hz, n=7), which resembled 25 Hz optogenetic stimulation. During the electrical stimulation the BOLD signal increased in regions connected to the reward network. These BOLD responses were even more widespread than the once observed upon optogenetic less-specific stimulation. The release of dopamine upon electrical stimulation was confirmed by FSCV.

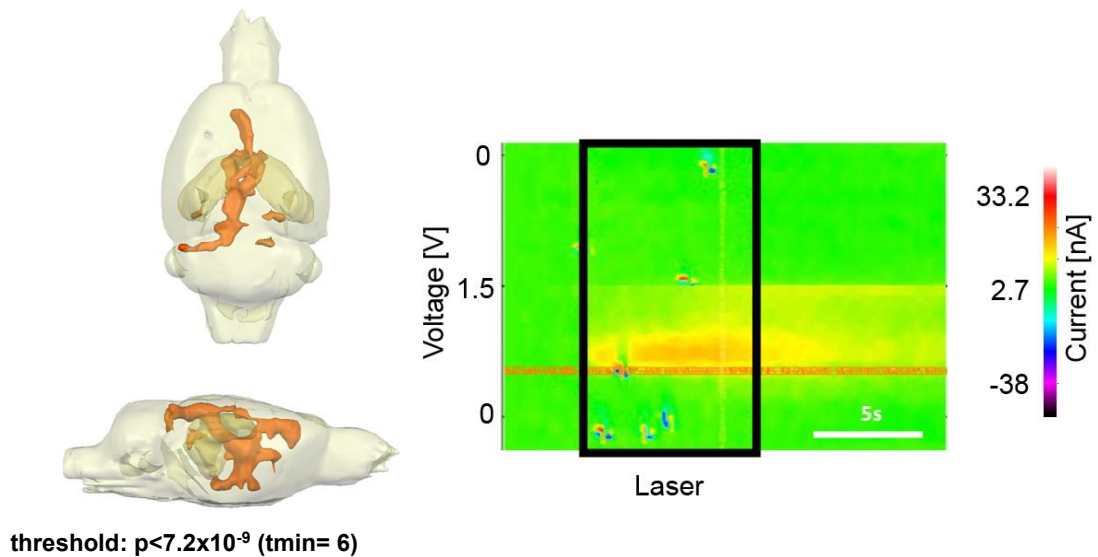

Figure 6. Electrical stimulation of the VTA leads to the widespread increase of BOLD signal ( $n=7$ ) and release of dopamine into NAcc ( $3.5 \pm 0.4 \mu\text{M}$ ). Adapted from Helbing et al., 2016.

#### 4.1.2 Blockade of dopaminergic $D_{1,5}$ receptors does not influence BOLD responses evoked by electrical stimulation

To investigate the source of the signals from electrically stimulated animals ( $n=7$ ), we applied the dopamine  $D_{1,5}$  receptor blocker SCH23390. Surprisingly, the signal was still visible in NAcc and mPFC/ACC. On the other hand, application of MK801 (NMDA receptor blocker) visibly decreased the formation of BOLD responses in these regions. This observation indicates that a canonical BOLD response in the regions connected to reward network may not be directly related to DA release.



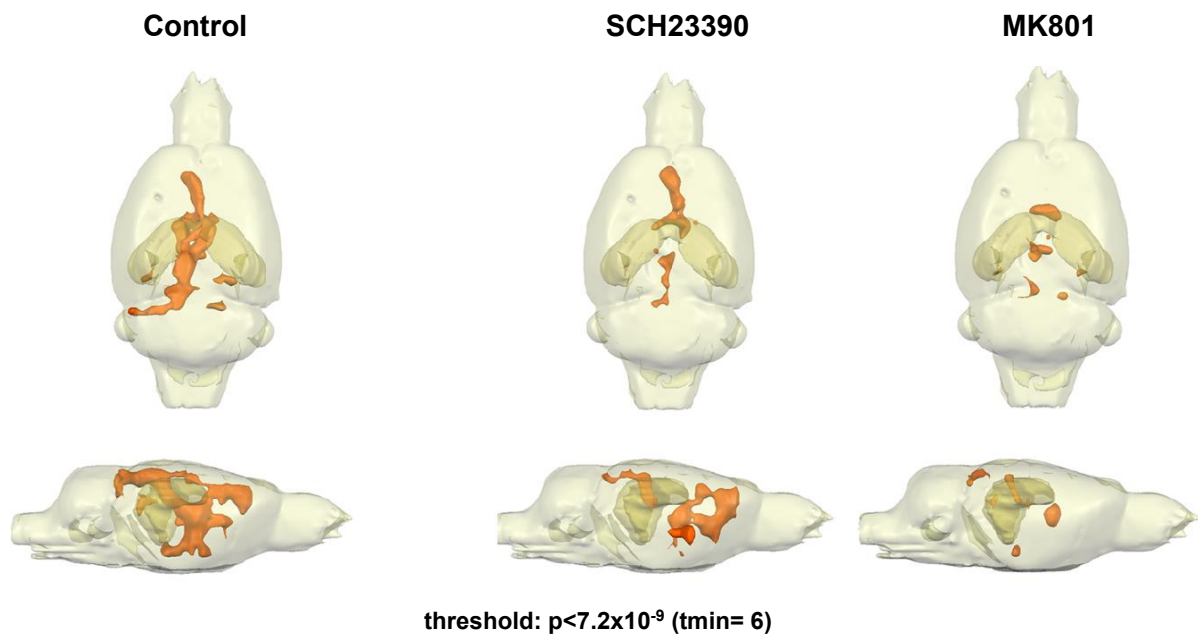

Figure 7. Electrical stimulation of the VTA (n=7). Only application of NMDA receptor blocker (MK801) leads to clear decrease of BOLD signal. Adapted from Helbing et al., 2016.

## 4.2 Study II

Animals placed in fMRI have to be either immobilized or sedated. In our experiments we used medetomidine (dormitor) for sedation. It is known, however, that different pharmacological agents can influence BOLD signals (Krautwald and Angenstein, 2011). On the other hand, immobilization causes distress and discomfort in animals and requires training for a couple of days before the scanning session. All of these undesirable factors may influence fMRI results. Therefore we decided to compare fMRI BOLD measurements of sedated animals with rCBF-SPECT of awake animals.

### 4.2.1 Intracranial self-stimulation is acquired at comparable levels in case of less-specific and dopamine specific stimulation

At first, we wanted to determine if optogenetic stimulation in both rat groups had comparable rewarding values. Thus, all of the subjects underwent ICSS training during 10 consecutive days. The animals were placed in a self-stimulation chamber with a nose-poke lever. Upon pressing the lever, they received light stimulation to their VTA. The acquisition of behavior was very similar between the two groups, which confirms the observation that dopamine is

necessary for ICSS (Beier et al., 2015; Ilango et al., 2014; Steinberg et al., 2014; Witten et al., 2011). The animals which pressed more than 400 times during 30 min of training were included in further experiments.

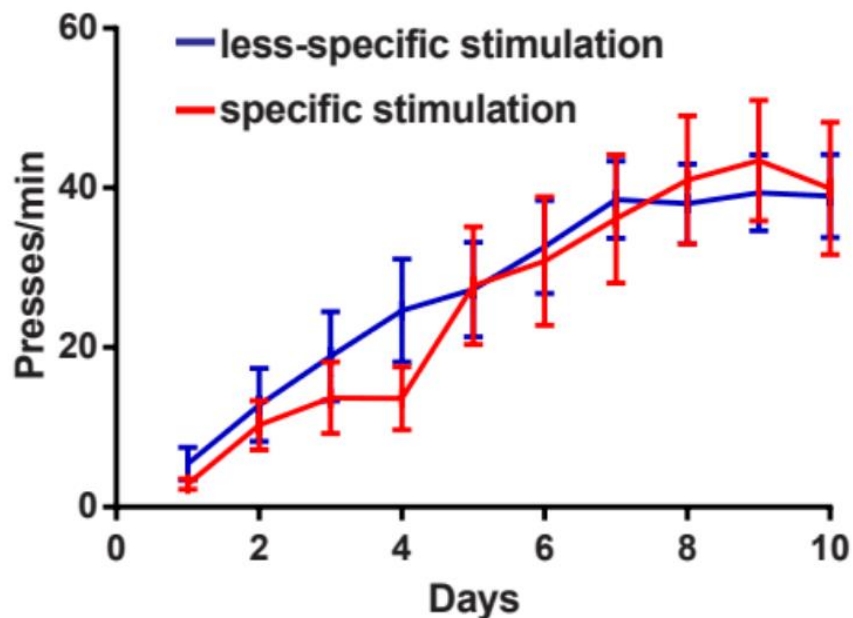

Figure 8. ICSS training results. Mean press rates for rats which underwent dopamine specific and less-specific stimulation were not significantly different (Wilcoxon rank sum test,  $p=0.375$ ). Adapted from Brocka et al. (2018).

#### 4.2.2 fMRI results confirmed findings from Study I

After the training, animals underwent fMRI measurement (optogenetic stimulation of 25 Hz, 10 mW from the tip of the fiber, 15 trains). We also used 7 other animals for electrical stimulation of the VTA (with the parameters from Study I). New fMRI results confirmed our previous observations — upon stimulation, we saw broad patterns of BOLD responses due to electrical and less-specific stimulation, whereas upon specific stimulation changes were focused in the thalamus and tectum. Control animals, which expressed only an eYFP marker, but no opsin in the VTA, showed only a slight increase in BOLD signal in the thalamus.

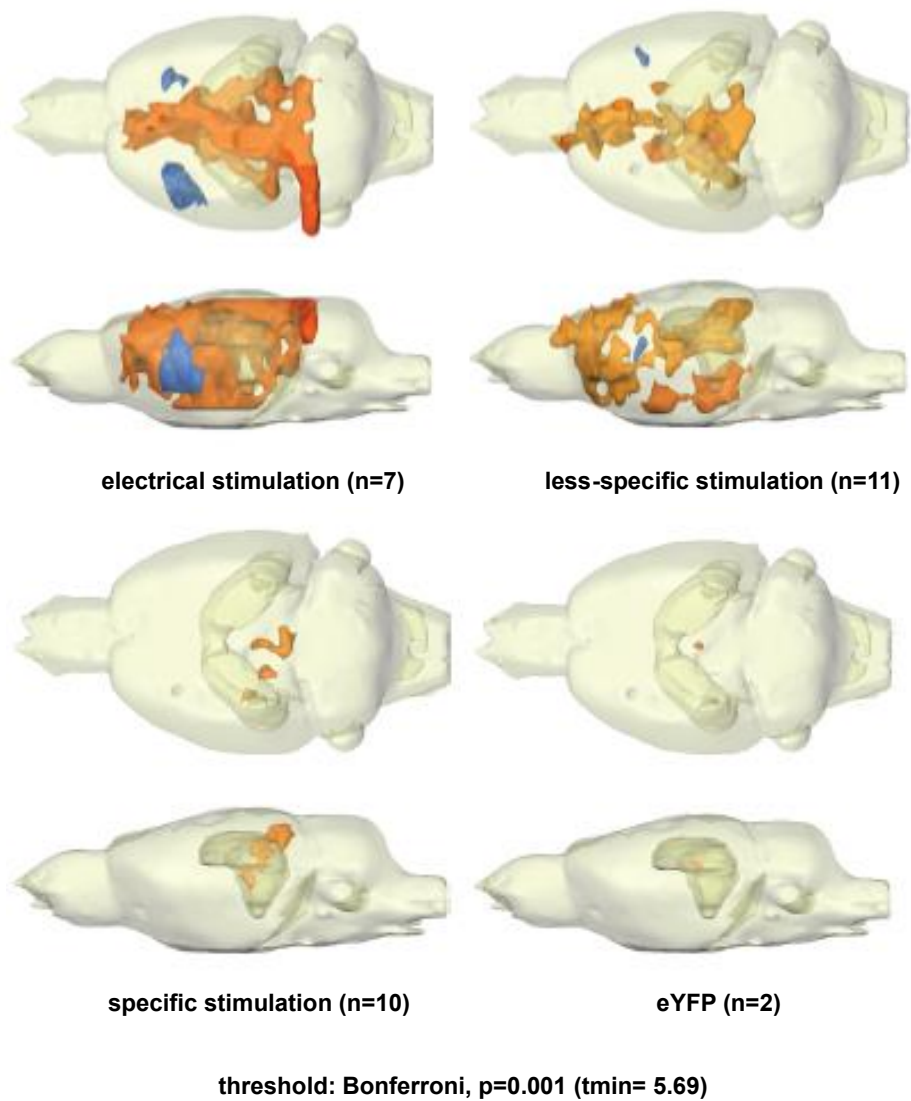

Figure 9. Distribution of BOLD signal during electrical, optogenetic specific and less-specific stimulation and in controls (expressing only eYFP, but no opsin). Adapted from Brocka et al. (2018).

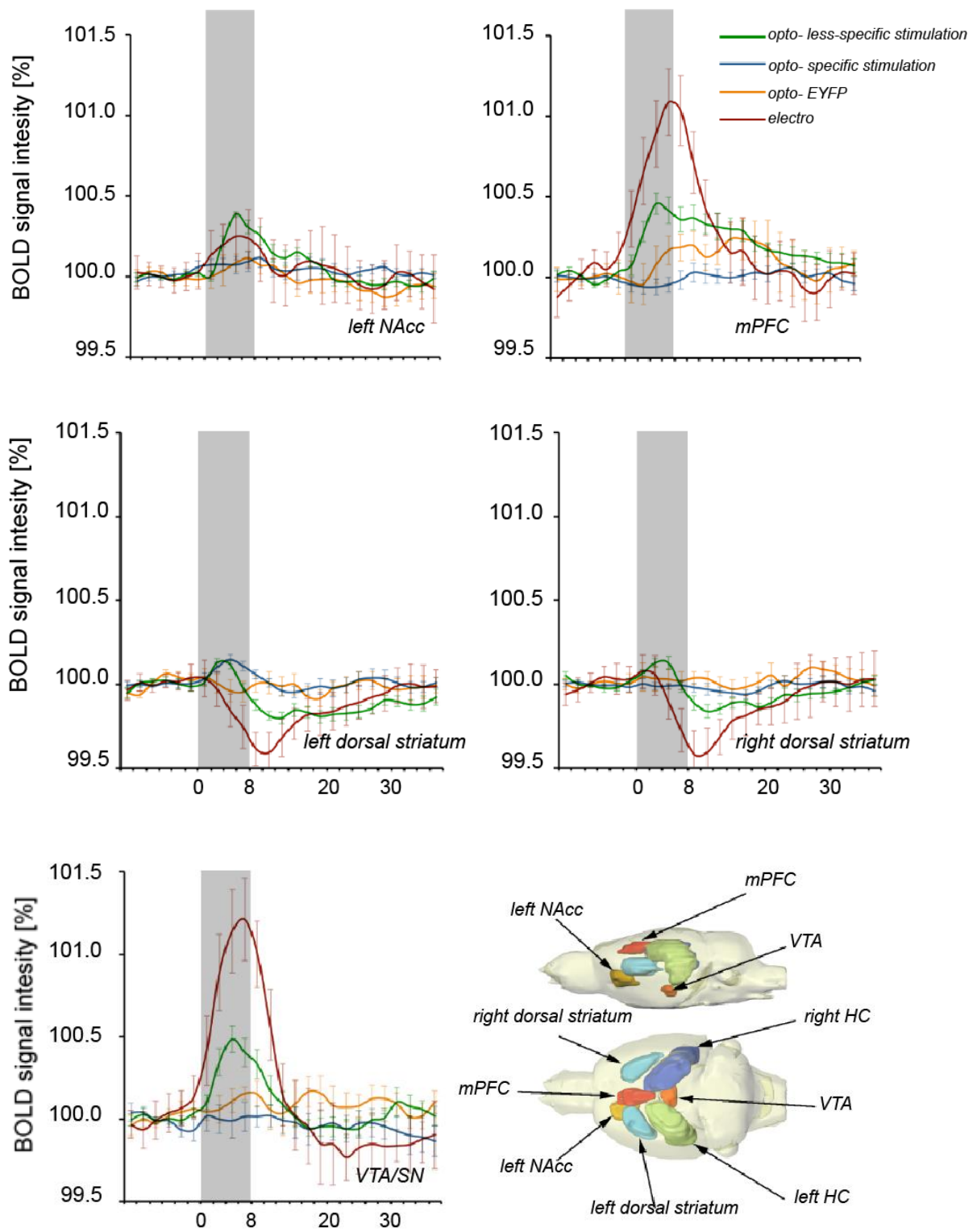

Figure 9. Magnitude of BOLD responses in volumes of interest (VOI). BOLD time series in selected brain structures are shown averaged across all voxels and trains (gray bar indicates stimulation duration). Adapted from Brocka et al. (2018).

Blockade of dopamine D<sub>1,5</sub> receptors by SCH23390 was not accompanied by the decrease of BOLD signal during less-specific stimulation.

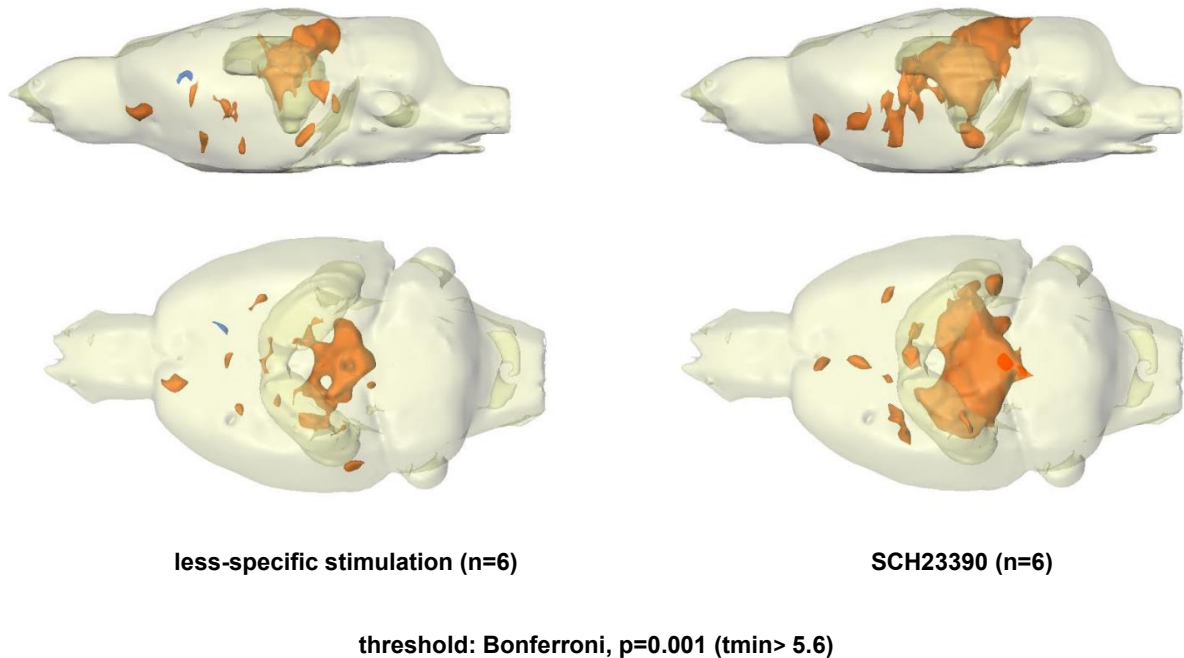

Figure 10. Blockade of D<sub>1,5</sub> receptors did not cause the decrease of BOLD response. Adapted from Brocka et al. (2018).

#### 4.2.3 Optogenetic less-specific and dopamine specific stimulation has different effects on rCBF

Subsequently, the same opsin-expressing rats underwent awake SPECT measurements. During the injection of radioactive tracer, the animals were stimulated optogenetically with the same parameters, as were used during fMRI scan. The only difference was that trains were repeated 10 times instead of 15 times. The results from SPECT resembled those from fMRI. Less-specific stimulation led to the increase of blood flow in stimulated area and left NAcc, whereas we did not observe any comparable results upon specific stimulation. In contrast to fMRI, we did not detect increased activity in mPFC, but rather a decrease in tracer accumulation in prelimbic/infralimbic cortex for both stimulation paradigms.

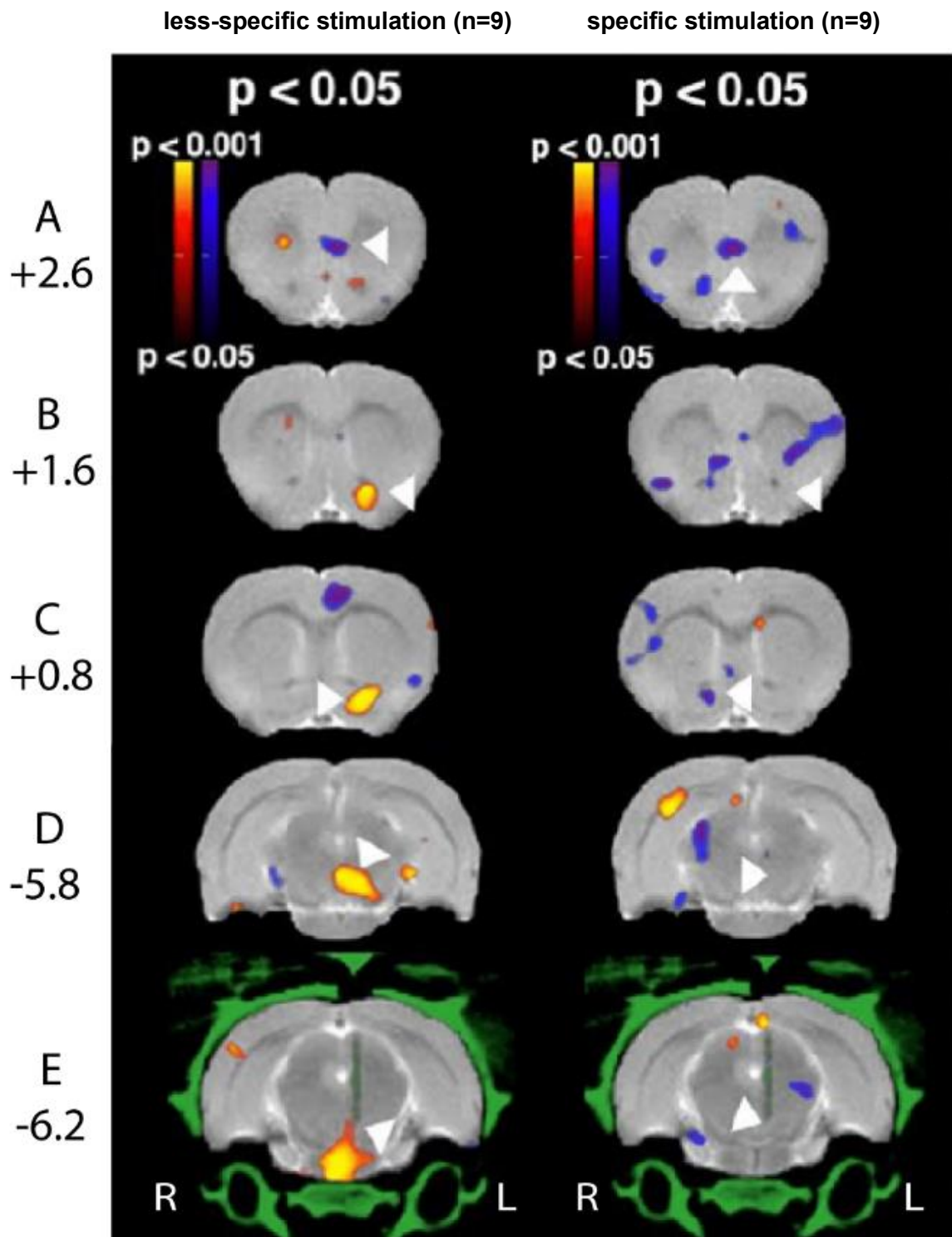

Figure 11. Changes in rCBF induced by optogenetic VTA stimulation. Significant increases (yellow) and decreases (blue/violet) of  $^{99m}\text{TcHMPAO}$  tracer uptake are shown in the map. Maps of statistically significant voxels are overlaid on a reference MR. An overlay of the added CTs of all individuals in each group is shown in green in D. The location of optical fibers is indicated by arrows in D. Significant increase in tracer uptake is observed in case of less-specific, but not specific VTA stimulation in NAcc (A,B) and VTA (C,D). Adapted from Brocka et al. (2018).



#### 4.2.4 Temporal dissociation between DA-release and BOLD signal

We used FSCV to investigate if differences visible in neuroimaging emerged from different levels of dopamine release between the groups. Animals were anesthetized with urethane and the electrode was placed in the right NAcc (shell). DA release upon optogenetic stimulation of the VTA was measured during 10 consecutive stimulation trains (with parameters used during fMRI and SPECT experiments). In both animal groups, optogenetic stimulation caused a similar DA release in the nucleus accumbens and also exhibited similar temporal release characteristics.

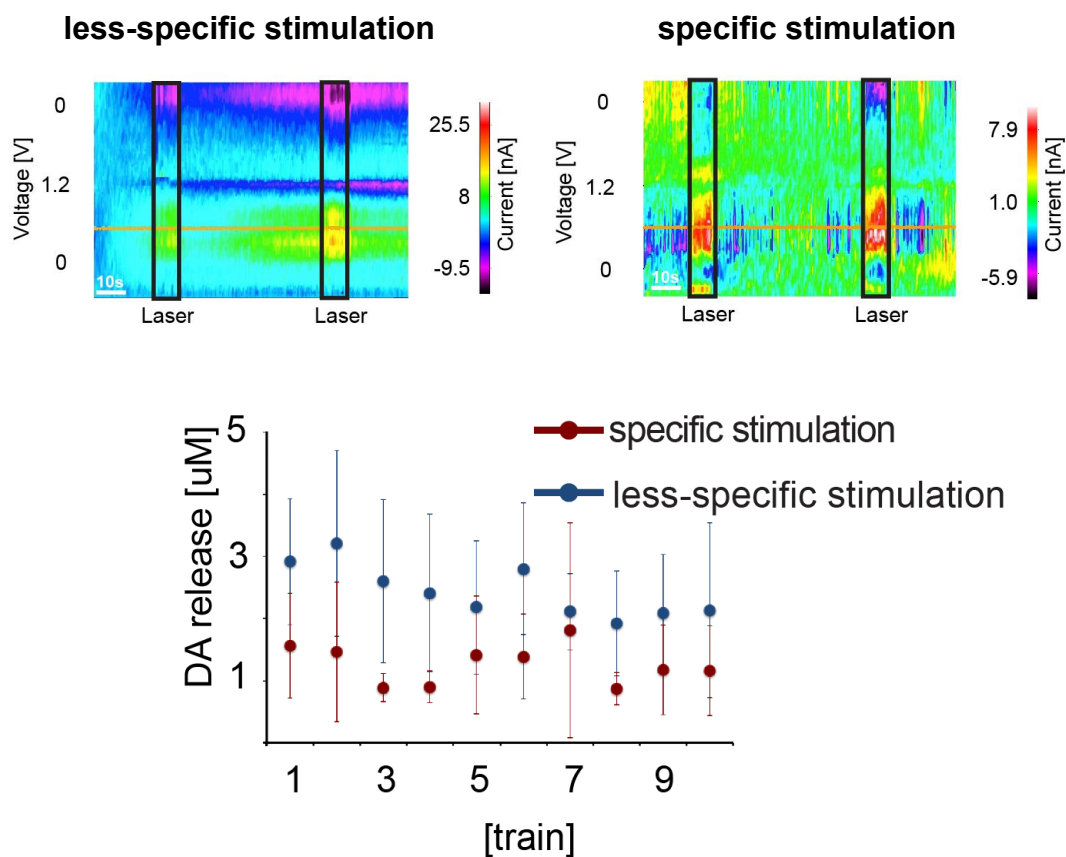

Figure 12. Dopamine release into the nucleus accumbens as detected by in vivo fast-scan cyclic voltammetry during less-specific (n=3) and specific (n=4) optogenetic VTA stimulation. The dopamine release was transient and repeatable during consecutive stimulations. The amount of dopamine released during optogenetic stimulation was similar between the groups. Adapted from Brocka et al. (2018).

We also observed the dissociation of neurovascular responses during less-specific stimulation and DA release, measured by FSCV. After about six stimulation trains, the BOLD responses started to disappear, while the DA release in NAcc was still relatively stable. Therefore, we cannot directly assume that BOLD signals measured during less-specific stimulation unequivocally mirror the DA release.

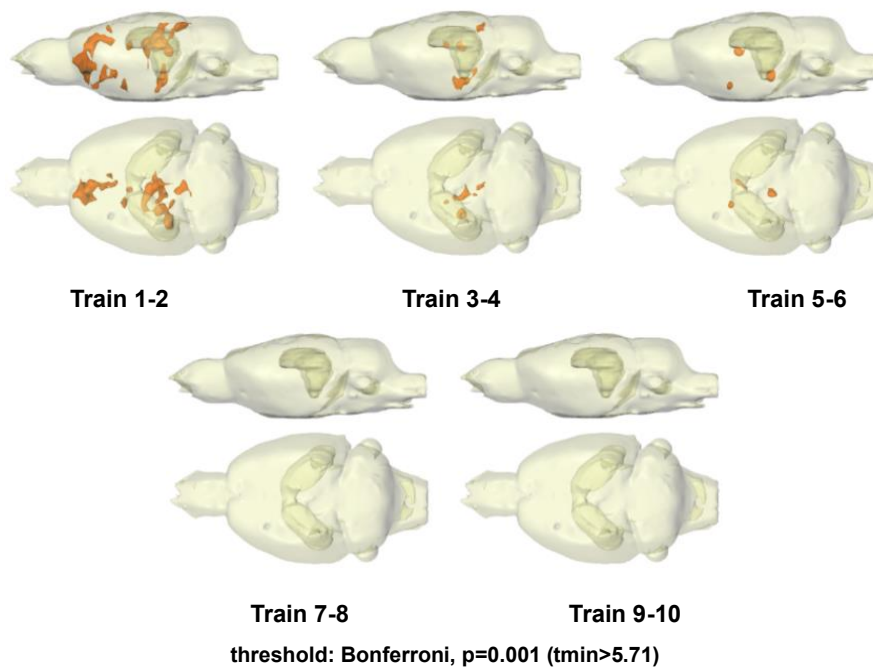

Figure 13. BOLD signal during the less-specific stimulation. Note gradual weakening of the signal during consecutive trains. Adapted from Brocka et al. (2018).

As expected, inspection of histological data revealed that the opsin in Th-Cre rats (specific stimulation) was mainly located in Th expressing cells, whereas in WT rats (less-specific stimulation) this expression was present also in Th-negative neurons.



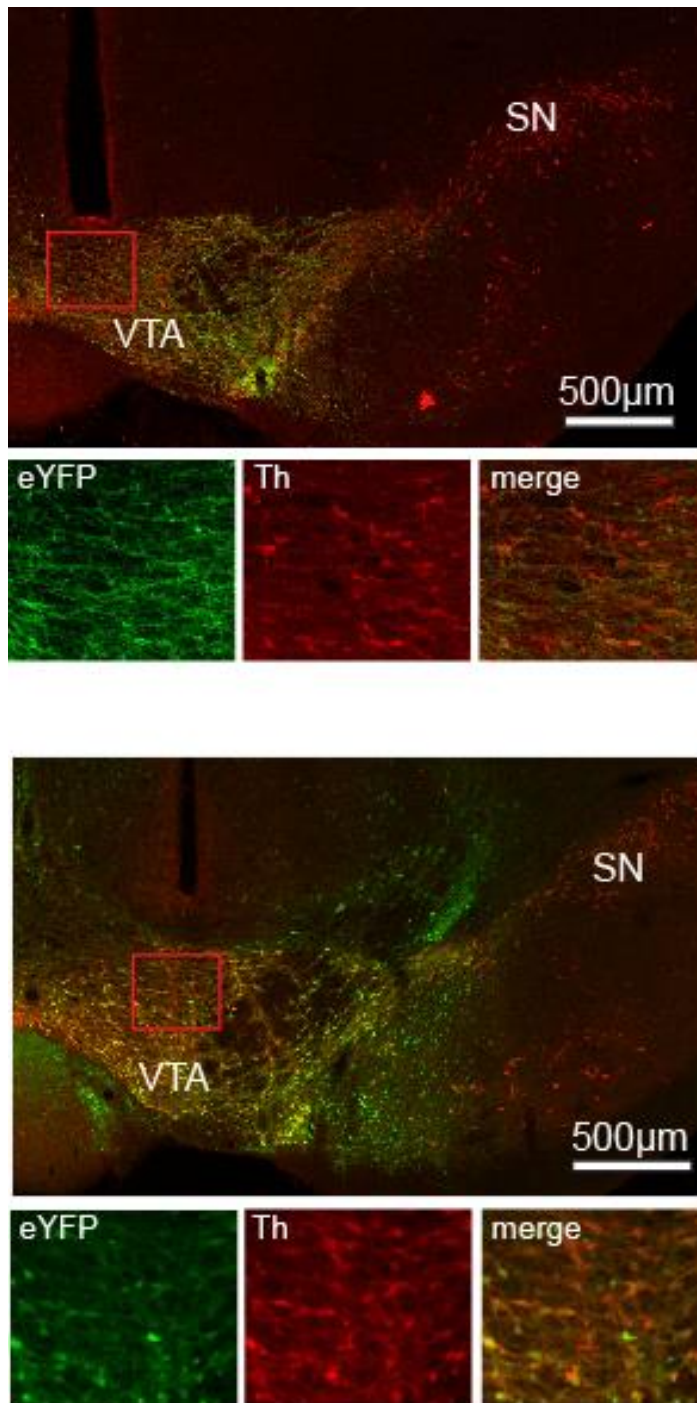

Figure 14. Picture above: Viral construct (EYFP, green cells) in Th-Cre animals (dopamine-specific stimulation) is mostly expressed in Th-positive dopaminergic cells (red cells). Picture below: In rats expressing viral construct under CaMKIIa promotor (less-specific stimulation) the opsin was also present in Th-negative cells. Adapted from Brocka et al. (2018).

## 5. Discussion

Our data show that the results from neuroimaging studies, focused on reward network, should be treated with caution. Activity detected in reward related structures may not be directly related to VTA dopamine release and, on the other hand, the absence of this activity does not equal absence of dopamine release.

The most interesting observation from the current study is that optogenetic less-specific and dopamine specific VTA stimulation led to very similar behavioral (ICSS) effects and comparable DA release (FSCV) yet resulted in surprisingly different neurovascular effects (fMRI and SPECT). Whereas during less-specific stimulation we observed broad BOLD responses in VTA and connected areas and increase of rCBF in NAcc and VTA, specific stimulation was followed only by increase in BOLD signal in visual areas. The pattern of signals evoked by electrical stimulation was similar to optogenetic less-specific stimulation, although the magnitude was higher.

### 5.1 Specificity of stimulation

The methods used in the current work targeted dopaminergic cells with different specificity. The least specific would be electrical stimulation. As already mentioned above, electrical stimulation non-selectively activates or inhibits cells, depending on their orientation and distance from the electrode (Ranck, 1975). Not only does it send anterograde impulses to the VTA target regions, but in contrast to optogenetics, also retrogradely stimulates regions projecting onto the VTA. By using the NMDA receptor blocker MK801 we confirmed that BOLD responses were mainly driven by glutamate, whereas dopamine only played a marginal role (Fig.7).

Less-specific optogenetic stimulation targeted mixed population of VTA neurons in WT rats. It results in release of different neurotransmitters from the VTA cells. This combined release appears to be crucial for increase in BOLD signal and rCBF. Moreover, dopamine release measured by FSCV is relatively stable over 10 trains of stimulation, yet the BOLD signal disappears over time. Even if we assume that dopamine may drive the BOLD response at the beginning of the stimulation, release of this neurotransmitter does not reliably predict the BOLD response.

The most specific of the used methods is optogenetic stimulation of dopaminergic cells in Th-Cre rats. Although the dopaminergic cells are targeted with high precision (Witten et al., 2011), it is worth mentioning that the stimulation of dopaminergic cells does not equal dopamine release alone. It is known that some dopaminergic cells also corelease glutamate and GABA (Tritsch et al., 2012, 2014, 2016). Our results, however, indicate that none of these other

neurotransmitters released from dopaminergic cells, have a great impact on the formation of BOLD response and changes in rCBF. Moreover, BOLD responses, which crossed the statistical threshold, were located in visual areas. These were likely visual artefacts (not visible to that extent in control animals due to differences in the number of subjects) or indications of plastic changes, which originated from pairing the light used for optogenetic stimulation with dopamine release.

## 5.2 Comparison to other optogenetic studies

The influence of dopamine on neurovascular responses has been further investigated by other research groups. Ferenczi et al. (2016) and Lohani et al. (2016) also used optogenetic stimulation of the VTA dopaminergic cells to investigate the influence of dopamine on the formation of a BOLD response. Upon stimulation, they observed an increase in BOLD signals mainly in the striatum. To explain the discrepancy between these studies and our current work, we compared the experimental designs.

- 1) Animal state: Ferenczi et al. used awake rats for fMRI measurements; Lohani et al. anesthetized animals with isoflurane, whereas we used medetomidine sedation. It is understandable that the result of the stimulation may depend on the initial state of an animal. To address this problem, we obtained rCBF-SPECT images of awake rats, stimulated optogenetically. These images, however, mostly confirmed our fMRI results: specific stimulation did not lead to increased tracer accumulation in reward-related regions.
- 2) Stimulation parameters: Each group used different stimulation parameters. Lohani et al. referred to our study (Helbing et al., 2015) and claimed that the lack of observed BOLD signal changes results from too short stimulation. It is, however, hard to find the justification for using longer stimulation. First, our paradigm leads to clear dopamine release, which does not seem to have an impact neither on BOLD signal nor on rCBF. Second, in physiological conditions burst firing of dopaminergic neurons lasts about one hundred milliseconds (Schulz et al., 1997), so prolonged stimulation with high frequency may have no physiological relevance. Third, the observed BOLD signal after long stimulation of VTA neurons may not be directly connected to dopamine release, but to secondary effects evoked by overstimulation.
- 3) Scanner magnetic field: Ferenczi et al. and Lohani et al. performed their measurements in 7 T and 9.4 T scanners, respectively. The magnetic field of our

scanner is lower (4.7 T), but still enables us to compare our results with human studies, which have typically been carried out in lower field scanners than what is currently available for rodent research (Alves et al., 2010; D'Ardenne et al., 2008; Knutson et al., 2004). In the current study we still could observe a canonical BOLD response evoked by electrical and less-specific optogenetic stimulation. Scanners using higher magnetic fields are better in detecting smaller changes in BOLD signal, but the physiological meaning of these changes is not clear.

According to Ferenczi et al. and Lohani et al., stimulation of dopaminergic VTA cells leads to an increase of BOLD response mostly in dorsal and ventral striatum. Our results, however, confirm these observations only partially. Specific stimulation of dopaminergic VTA neurons results in very low levels of BOLD signal in nucleus accumbens and the dorsal striatum. Using standard statistical methods, these activations would not be detectable in our experiments. The magnitude of the activations in the region of below 0.2-0.5% is comparable to previous research (Ferenczi et al., 2016) but small compared to effects observed upon less-specific or electrical stimulation.

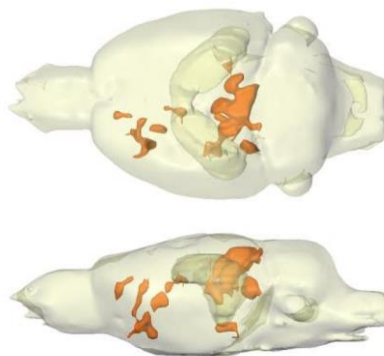

**specific stimulation (n=10)**

**Threshold: no correction,  $p=0.01$  ( $t_{min}=3.54$ )**

Figure 15. Dopamine specific stimulation after lowering the threshold and removing Bonferroni correction. Even at a low threshold, significantly activated voxels are mainly located in the thalamus and tectal area, however, some responses also appear in reward related areas. Adapted from Brocka et al. (2018).

### 5.3 Differences between fMRI and SPECT

In the current work we compared the results from fMRI (sedated animals) with SPECT (awake animals). Regardless of the technique, we observed higher activation of reward-related

network upon less-specific stimulation than upon specific stimulation. However, only in SPECT we observed a decrease in prefrontal/infralimbic cortex in both animal models. These differences may originate from the state of the animals (awake vs sedated), but also from the specifics of both neuroimaging methods. The BOLD responses are stimulus-locked, which means that the signal alterations can be observed with relatively high temporal resolution. SPECT detects the rCBF changes accumulated during the whole stimulation period. Long stimulation may lead to the shift in neuronal baseline activity, which cannot be filtered out from the “frozen” rCBF signal.

#### 5.4 Relevance for human studies

Motivation, decision making, and learning are well-known cognitive processes regulated by DA. The dopaminergic system also plays an important role in psychiatric conditions in humans such as schizophrenia, depression and addiction. That is why the contribution of dopamine to the BOLD response is a widely discussed topic (Düzel et al., 2009; Knutson and Gibbs, 2007). If the BOLD signal in output regions of the VTA was directly correlated to the DA release, we would obtain a good tool to study the functions and malfunctions of the dopaminergic system. Although such a scenario has been suggested (D’Ardenne et al., 2008; Knutson and Gibbs, 2007; Schott et al., 2008), our results demonstrate that caution is necessary when interpreting BOLD signals with respect to underlying dopaminergic activity.

##### 5.4.1 Constraints of translating results from animal studies to human studies

Optogenetics has an advantage over non-invasive human experiments in studying particular phenomena (like dopamine release) because of its high precision and temporal resolution. Notwithstanding, there are several constraints of animal models (like the one used in our study) which should be considered.

- 1) As already pointed out by Düzel et al. (2009), the anatomical and functional distinction between VTA and SN is very clear in rodents, but not in primates, in which the border between these structures is not visible.
- 2) In the current study, we targeted one part of the VTA which is defined by supporting reliable self-stimulation behavior. However, the VTA is significantly more diverse and parcellated into different subfields, which target different brain regions (Aransay et al.,

2015). The profile and number of dopaminergic neurons also differs between these subfields (Barker et al., 2016). Moreover, the receptor profile of the target neurons differs among targets, leading to rather activating ( $D_1$  receptor dominates) or deactivating effects ( $D_2$  receptor dominates). As a result, the stimulation of different VTA subfields might lead to differing results.

- 3) The ratio of  $D_1$  to  $D_2$  receptors is higher in the rats than in mice, non-human primates and humans (Mandeville et al., 2013). That may contribute to the differences in neuroimaging results between rats and other species. Higher ratio of  $D_1$  to  $D_2$  receptors should, however, increase the possibility of detecting dopamine-mediated BOLD signals, since according to Knutson and Gibbs (2007), activation of  $D_1$  receptors in NAcc increases the local BOLD response. If the theory of Knutson and Gibbs was correct, we should be more likely to observe changes in BOLD signal in rats than in other species. However, our results (from specific optogenetic stimulation and less-specific stimulation in presence of  $D_{1,5}$  receptor blocker) question the aforementioned theory.

## 6. Conclusions

Unlike the selective optogenetic stimulation of DA VTA neurons, optogenetic or electrical stimulation caused much more widespread changes in BOLD, reminiscent of the patterns observed in human studies. Therefore, we suggest that reward-related neurovascular signals, classically associated with dopamine release, are unlikely to be driven by dopamine. We consider it therefore possible that the activity of glutamatergic cells, inhibition from co-stimulated inhibitory cells, or non-neuronal processes are mainly driving observed classical BOLD signals. This should be, however, determined in the future studies. The main aim of this work is to point out that the dopamine may play a less important role in driving neurovascular responses than currently assumed. Therefore, we call for cautious interpretation of neuroimaging data.

## Erklärung

Magister Brocka, Marta

Tel. 01785592314

Ebendorfer Str, 52

39108 Magdeburg

## Erklärung

Hiermit erkläre ich, dass ich die von mir eingereichte Dissertation zum dem Thema:

Imaging the functional networks influenced by VTA stimulation

selbständig verfasst, nicht schon als Dissertation verwendet habe und die benutzten Hilfsmittel und Quellen vollständig angegeben wurden.

Weiterhin erkläre ich, dass ich weder diese noch eine andere Arbeit zur Erlangung des akademischen Grades doctor rerum naturalium (Dr. rer. nat.) an anderen Einrichtungen eingereicht habe.

Magdeburg, den 6.02.2018

## Scientific publications:

**Brocka, M.**, Helbing, C., Vincenz, D., Scherf, T., Montag, D., Goldschmidt, J., Angenstein, F., Lippert, M. (2018). Contributions of dopaminergic and non-dopaminergic neurons to VTA-stimulation induced neurovascular responses in brain reward circuits. *NeuroImage*, 177, 88-97, doi:10.1016/j.neuroimage.2018.04.059

Helbing, C., **Brocka, M.**, Scherf, T., Lippert, M. T., & Angenstein, F. (2016). The role of the mesolimbic dopamine system in the formation of blood-oxygen-level dependent responses in the medial prefrontal/anterior cingulate cortex during high-frequency stimulation of the rat perforant pathway. *Journal of Cerebral Blood Flow and Metabolism*, 36(12), 2177-2193. doi:10.1177/0271678X15615535

Górska, U., Koculak, M., **Brocka, M.**, & Binder, M. (2014). Disorders of consciousness - clinical and ethical perspective. *Aktualności Neurologiczne*, 14(3), 190-198. doi:10.15557/AN.2014.0022

Górska, U., Gociewicz K., Koculak, M., Jurasinska A., **Brocka, M.**, & Binder, M. (2016). Disorders of consciousness in view of neuroimaging. *Aktualności Neurologiczne*, 16 (1), 37-49 doi:10.15557/AN.2016.0006



## Bibliography

- Alves, F Da Silva, et al. "Dopaminergic Modulation of Human Reward System: a Placebo Controlled Dopamine Depletion fMRI Study." *NeuroImage*, vol. 47, 2009.
- Angenstein, F., et al. "The BOLD Response in the Rat Hippocampus Depends Rather on Local Processing of Signals than on the Input or Output Activity. A Combined Functional MRI and Electrophysiological Study." *Journal of Neuroscience*, vol. 29, no. 8, 2009, pp. 2428–2439.
- Aransay, Ana, et al. "Long-Range Projection Neurons of the Mouse Ventral Tegmental Area: a Single-Cell Axon Tracing Analysis." *Frontiers in Neuroanatomy*, vol. 9, 2015.
- Arsenault, John T., et al. "Role of the Primate Ventral Tegmental Area in Reinforcement and Motivation." *Current Biology*, vol. 24, no. 12, 2014, pp. 1347–1353.
- Attwell, David, and Costantino Iadecola. "The Neural Basis of Functional Brain Imaging Signals." *Trends in Neurosciences*, vol. 25, no. 12, 2002, pp. 621–625.
- Barker, David J., et al. "Multiplexed Neurochemical Signaling by Neurons of the Ventral Tegmental Area." *Journal of Chemical Neuroanatomy*, vol. 73, 2016, pp. 33–42.
- Beaulieu, J.-M., and R. R. Gainetdinov. "The Physiology, Signaling, and Pharmacology of Dopamine Receptors." *Pharmacological Reviews*, vol. 63, no. 1, Aug. 2011, pp. 182–217.
- Beier, Kevin T., et al. "Circuit Architecture of VTA Dopamine Neurons Revealed by Systematic Input-Output Mapping." *Cell*, vol. 162, no. 3, 2015, pp. 622–634.
- Britt, Jonathan P., et al. "Synaptic and Behavioral Profile of Multiple Glutamatergic Inputs to the Nucleus Accumbens." *Neuron*, vol. 76, no. 4, 2012, pp. 790–803.
- Buck, A. K., et al. "SPECT/Ct." *Journal of Nuclear Medicine*, vol. 49, no. 8, 2008, pp. 1305–1319.
- Buzsáki, György, et al. "Inhibition and Brain Work." *Neuron*, vol. 56, no. 5, 2007, pp. 771–783.
- Carlezon, William A, and Elena H Chartoff. "Intracranial Self-Stimulation (ICSS) in Rodents

- to Study the Neurobiology of Motivation.” *Nature Protocols*, vol. 2, no. 11, 2007, pp. 2987–2995.
- Chang, Chun Yun, et al. “Brief Optogenetic Inhibition of Dopamine Neurons Mimics Endogenous Negative Reward Prediction Errors.” *Nature Neuroscience*, vol. 19, no. 1, July 2015, pp. 111–116.
- Chen, Yin Ching I., et al. “Detection of Dopaminergic Neurotransmitter Activity Using Pharmacologic MRI: Correlation with PET, Microdialysis, and Behavioral Data.” *Magnetic Resonance in Medicine*, vol. 38, no. 3, 1997, pp. 389–398.
- Choi, Ji-Kyung, et al. “Brain Hemodynamic Changes Mediated by Dopamine Receptors: Role of the Cerebral Microvasculature in Dopamine-Mediated Neurovascular Coupling.” *NeuroImage*, vol. 30, no. 3, 2006, pp. 700–712.
- Christie, Isabel N., et al. “fMRI Response to Blue Light Delivery in the Naïve Brain: Implications for Combined Optogenetic fMRI Studies.” *NeuroImage*, vol. 66, 2013, pp. 634–641.
- Christie, Isabel N., et al. “Volumetric Spatial Correlations of Neurovascular Coupling Studied Using Single Pulse Opto-fMRI.” *Scientific Reports*, vol. 7, Aug. 2017, p. 41583.
- Cohen, Eric R., et al. “Effect of Basal Conditions on the Magnitude and Dynamics of the Blood Oxygenation Level-Dependent fMRI Response.” *Journal of Cerebral Blood Flow & Metabolism*, vol. 22, no. 9, 2002, pp. 1042–1053.
- Cook-Snyder, Denise R., et al. “A Retrograde Adeno-Associated Virus for Collecting Ribosome-Bound mRNA from Anatomically Defined Projection Neurons.” *Frontiers in Molecular Neuroscience*, vol. 8, 2015.
- Creed, Meaghan C., et al. “VTA GABA Neurons Modulate Specific Learning Behaviors through the Control of Dopamine and Cholinergic Systems.” *Frontiers in Behavioral Neuroscience*, vol. 8, 2014.
- D’Ardenne, K., et al. “BOLD Responses Reflecting Dopaminergic Signals in the Human Ventral Tegmental Area.” *Science*, vol. 319, no. 5867, 2008, pp. 1264–1267.
- Decot, Heather K, et al. “Coordination of Brain-Wide Activity Dynamics by Dopaminergic

- Neurons." *Neuropsychopharmacology*, vol. 42, no. 3, Dec. 2016, pp. 615–627.
- Dobi, A., et al. "Glutamatergic and Nonglutamatergic Neurons of the Ventral Tegmental Area Establish Local Synaptic Contacts with Dopaminergic and Nondopaminergic Neurons." *Journal of Neuroscience*, vol. 30, no. 1, June 2010, pp. 218–229.
- Dreyer, J. K., et al. "Influence of Phasic and Tonic Dopamine Release on Receptor Activation." *Journal of Neuroscience*, vol. 30, no. 42, 2010, pp. 14273–14283.
- Dreyer, J. K., and Jørn Hounsgaard. "Mathematical Model of Dopamine Autoreceptors and Uptake Inhibitors and Their Influence on Tonic and Phasic Dopamine Signaling." *Journal of Neurophysiology*, vol. 109, no. 1, 2013, pp. 171–182.
- Düzel, Emrah, et al. "Functional Imaging of the Human Dopaminergic Midbrain." *Trends in Neurosciences*, vol. 32, no. 6, 2009, pp. 321–328.
- Ekstrom, Arne. "How and When the fMRI BOLD Signal Relates to Underlying Neural Activity: The Danger in Dissociation." *Brain Research Reviews*, vol. 62, no. 2, 2010, pp. 233–244.
- Endepols, H., et al. "Effort-Based Decision Making in the Rat: An [18F]Fluorodeoxyglucose Micro Positron Emission Tomography Study." *Journal of Neuroscience*, vol. 30, no. 29, 2010, pp. 9708–9714.
- Faget, Lauren. "Afferent Inputs to Transmitter-Defined Cell Types in the Ventral Tegmental Area." *Intrinsic Activity*, vol. 4, no. Suppl. 2, 2016.
- Febo, Marcelo, et al. "Imaging Cocaine-Induced Changes in the Mesocorticolimbic Dopaminergic System of Conscious Rats." *Journal of Neuroscience Methods*, vol. 139, no. 2, 2004, pp. 167–176.
- Ferenczi, E. A., et al. "Prefrontal Cortical Regulation of Brainwide Circuit Dynamics and Reward-Related Behavior." *Science*, vol. 351, no. 6268, 2015.
- Floresco, Stan B, et al. "Glutamatergic afferents from the hippocampus to the nucleus accumbens regulate activity of ventral tegmental area dopamine neurons." *Journal of Neuroscience*, vol. 21, no. 13, 2001, pp. 4915–4922.
- Floresco, Stan B, et al. "Afferent Modulation of Dopamine Neuron Firing Differentially

- Regulates Tonic and Phasic Dopamine Transmission.” *Nature Neuroscience*, vol. 6, no. 9, Mar. 2003, pp. 968–973.
- Ghahremani, D. G., et al. “Striatal Dopamine D2/D3 Receptors Mediate Response Inhibition and Related Activity in Frontostriatal Neural Circuitry in Humans.” *Journal of Neuroscience*, vol. 32, no. 21, 2012, pp. 7316–7324.
- Gigante, Eduardo D., et al. “Optogenetic Activation of a Lateral Hypothalamic-Ventral Tegmental Drive-Reward Pathway.” *Plos One*, vol. 11, no. 7, July 2016.
- Grace, A.a., and B.s. Bunney. “Intracellular and Extracellular Electrophysiology of Nigral Dopaminergic Neurons—3. Evidence for Electrotonic Coupling.” *Neuroscience*, vol. 10, no. 2, 1983, pp. 333–348.
- Helbing, Cornelia, et al. “The Role of the Mesolimbic Dopamine System in the Formation of Blood-Oxygen-Level Dependent Responses in the Medial Prefrontal/Anterior Cingulate Cortex during High-Frequency Stimulation of the Rat Perforant Pathway.” *Journal of Cerebral Blood Flow & Metabolism*, vol. 36, no. 12, 2016, pp. 2177–2193.
- Hnasko, T. S., et al. “Ventral Tegmental Area Glutamate Neurons: Electrophysiological Properties and Projections.” *Journal of Neuroscience*, vol. 32, no. 43, 2012, pp. 15076–15085.
- Hsu, Y.-W. A., et al. “Role of the Dorsal Medial Habenula in the Regulation of Voluntary Activity, Motor Function, Hedonic State, and Primary Reinforcement.” *Journal of Neuroscience*, vol. 34, no. 34, 2014, pp. 11366–11384.
- Huneau, Clément, et al. “Investigating Human Neurovascular Coupling Using Functional Neuroimaging: A Critical Review of Dynamic Models.” *Frontiers in Neuroscience*, vol. 9, 2015.
- Iadecola, Costantino. “Neurovascular Regulation in the Normal Brain and in Alzheimer's Disease.” *Nature Reviews Neuroscience*, vol. 5, no. 5, 2004, pp. 347–360.
- Ilango, Anton, et al. “Phasic Excitation of Ventral Tegmental Dopamine Neurons Potentiates the Initiation of Conditioned Approach Behavior: Parametric and Reinforcement-

- Schedule Analyses." *Frontiers in Behavioral Neuroscience*, vol. 8, June 2014a.
- Ilango, Anton, et al. "Similar Roles of Substantia Nigra and Ventral Tegmental Dopamine Neurons in Reward and Aversion." *The Journal of Neuroscience*, vol. 34, no. 3, 2014b, pp. 817–822.
- Iordanova, Bistra, et al. "Neural and Hemodynamic Responses to Optogenetic and Sensory Stimulation in the Rat Somatosensory Cortex." *Journal of Cerebral Blood Flow & Metabolism*, vol. 35, no. 6, Nov. 2015, pp. 922–932.
- Jennings, Joshua H., et al. "Distinct Extended Amygdala Circuits for Divergent Motivational States." *Nature*, vol. 496, no. 7444, 2013, pp. 224–228.
- Ji, Lijun, et al. "Cortical Neurovascular Coupling Driven by Stimulation of Channelrhodopsin-2." *PLoS ONE*, vol. 7, no. 9, 2012.
- Johansen, Joshua P., et al. "Optical Activation of Lateral Amygdala Pyramidal Cells Instructs Associative Fear Learning." *Proceedings of the National Academy of Sciences*, vol. 107, no. 28, 2010, pp. 12692–12697.
- Kahn, I., et al. "Optogenetic Drive of Neocortical Pyramidal Neurons Generates fMRI Signals That Are Correlated with Spiking Activity." *Brain Research*, vol. 1511, 2013, pp. 33–45.
- Knutson, Brian, et al. "Amphetamine Modulates Human Incentive Processing." *Neuron*, vol. 43, no. 2, 2004, pp. 261–269.
- Knutson, Brian, and Sasha E. B. Gibbs. "Linking Nucleus Accumbens Dopamine and Blood Oxygenation." *Psychopharmacology*, vol. 191, no. 3, June 2007, pp. 813–822.
- Kolodziej, Angela, et al. "SPECT-Imaging of Activity-Dependent Changes in Regional Cerebral Blood Flow Induced by Electrical and Optogenetic Self-Stimulation in Mice." *NeuroImage*, vol. 103, 2014, pp. 171–180.
- Kozberg, Mariel G., et al. "Rapid Postnatal Expansion of Neural Networks Occurs in an Environment of Altered Neurovascular and Neurometabolic Coupling." *The Journal of Neuroscience*, vol. 36, no. 25, 2016, pp. 6704–6717.
- Krautwald, Karla, and Frank Angenstein. "Low Frequency Stimulation of the Perforant

- Pathway Generates Anesthesia-Specific Variations in Neural Activity and BOLD Responses in the Rat Dentate Gyrus.” *Journal of Cerebral Blood Flow & Metabolism*, vol. 32, no. 2, 2011, pp. 291–305.
- Lee, Jin Hyung, et al. “Global and Local fMRI Signals Driven by Neurons Defined Optogenetically by Type and Wiring.” *Nature*, vol. 465, no. 7299, 2010, pp. 788–792.
- Lee, T., et al. “Molecular-Level Functional Magnetic Resonance Imaging of Dopaminergic Signaling.” *Science*, vol. 344, no. 6183, Jan. 2014, pp. 533–535.
- Lippert, Michael T., et al. “Coupling of Neural Activity and fMRI-BOLD in the Motion Area MT.” *Magnetic Resonance Imaging*, vol. 28, no. 8, 2010, pp. 1087–1094.
- Liu, X. B., and E. G. Jones. “Localization of Alpha Type II Calcium Calmodulin-Dependent Protein Kinase at Glutamatergic but Not Gamma-Aminobutyric Acid (GABAergic) Synapses in Thalamus and Cerebral Cortex.” *Proceedings of the National Academy of Sciences*, vol. 93, no. 14, Sept. 1996, pp. 7332–7336.
- Liu, Zhixiang, et al. “Dorsal Raphe Neurons Signal Reward through 5-HT and Glutamate.” *Neuron*, vol. 81, no. 6, 2014, pp. 1360–1374.
- Logothetis, Nikos K., et al. “Neurophysiological Investigation of the Basis of the fMRI Signal.” *Nature*, vol. 412, no. 6843, Dec. 2001, pp. 150–157.
- Logothetis, Nikos K. “What We Can Do and What We Cannot Do with fMRI.” *Nature*, vol. 453, no. 7197, 2008, pp. 869–878.
- Lohani, S, et al. “Unexpected Global Impact of VTA Dopamine Neuron Activation as Measured by Opto-fMRI.” *Molecular Psychiatry*, vol. 22, no. 4, 2016, pp. 585–594.
- Mandeville, Joseph B., et al. “A Receptor-Based Model for Dopamine-Induced fMRI Signal.” *NeuroImage*, vol. 75, 2013, pp. 46–57.
- Marota, John J.a., et al. “Cocaine Activation Discriminates Dopaminergic Projections by Temporal Response: An fMRI Study in Rat.” *NeuroImage*, vol. 11, no. 1, 2000, pp. 13–23.
- Meikle, Steven R, et al. “Small Animal SPECT and Its Place in the Matrix of Molecular Imaging Technologies.” *Physics in Medicine and Biology*, vol. 50, no. 22, 2005.

- Michaelides, Michael, et al. "Whole-Brain Circuit Dissection in Free-Moving Animals Reveals Cell-Specific Mesocorticolimbic Networks." *Journal of Clinical Investigation*, vol. 123, no. 12, 2013, pp. 5342–5350.
- Mirenowicz, Jacques, and Wolfram Schultz. "Preferential Activation of Midbrain Dopamine Neurons by Appetitive Rather than Aversive Stimuli." *Nature*, vol. 379, no. 6564, 1996, pp. 449–451.
- Nagy, Andras. "Cre Recombinase: The Universal Reagent for Genome Tailoring." *Genesis*, vol. 26, no. 2, 2000, p. 99.
- Nair-Roberts, R.g., et al. "Stereological Estimates of Dopaminergic, GABAergic and Glutamatergic Neurons in the Ventral Tegmental Area, Substantia Nigra and Retrorubral Field in the Rat." *Neuroscience*, vol. 152, no. 4, 2008, pp. 1024–1031.
- Nieh, Edward H., et al. "Decoding Neural Circuits That Control Compulsive Sucrose Seeking." *Cell*, vol. 161, no. 6, 2015, pp. 1468–1471.
- Nir, Yuval, et al. "BOLD and Spiking Activity." *Nature Neuroscience*, vol. 11, no. 5, 2008, pp. 523–524.
- Ntamati, N. R., and C. Lüscher. "VTA Projection Neurons Releasing GABA and Glutamate in the Dentate Gyrus." *ENeuro*, vol. 3, no. 4, 2016.
- Ogawa, S et al. "Brain Magnetic Resonance Imaging with Contrast Dependent on Blood Oxygenation." *Proceedings of the National Academy of Sciences*, vol. 87, no. 24, 1990, pp. 9868–9872.
- Olds, James, and Peter Milner. "Positive Reinforcement Produced by Electrical Stimulation of Septal Area and Other Regions of Rat Brain." *Journal of Comparative and Physiological Psychology*, vol. 47, no. 6, 1954, pp. 419–427.
- O'Herron, Philip, et al. "Neural Correlates of Single-Vessel Haemodynamic Responses in Vivo." *Nature*, vol. 534, no. 7607, 2016, pp. 378–382.
- Parr-Brownlie, Louise C., et al. "Lentiviral Vectors as Tools to Understand Central Nervous System Biology in Mammalian Model Organisms." *Frontiers in Molecular Neuroscience*, vol. 8, 2015.

- Pasley, Brian N., and Ralph D. Freeman. "Neurovascular Coupling." *Scholarpedia*, [www.scholarpedia.org/article/Neurovascular\\_coupling](http://www.scholarpedia.org/article/Neurovascular_coupling).
- Pawela, Christopher P., et al. "Modeling of Region-Specific fMRI BOLD Neurovascular Response Functions in Rat Brain Reveals Residual Differences That Correlate with the Differences in Regional Evoked Potentials." *NeuroImage*, vol. 41, no. 2, 2008, pp. 525–534.
- Pinto, Daniel F. Cardozo, and Stephan Lammel. "Viral Vector Strategies for Investigating Midbrain Dopamine Circuits Underlying Motivated Behaviors." *Pharmacology Biochemistry and Behavior*, 2017.
- Prado, Luis, et al. "Activation of Glutamatergic Fibers in the Anterior NAc Shell Modulates Reward Activity in the ANAcSh, the Lateral Hypothalamus, and Medial Prefrontal Cortex and Transiently Stops Feeding." *The Journal of Neuroscience*, vol. 36, no. 50, 2016, pp. 12511–12529.
- Qi, Jia, et al. "VTA Glutamatergic Inputs to Nucleus Accumbens Drive Aversion by Acting on GABAergic Interneurons." *Nature Neuroscience*, vol. 19, no. 5, 2016, pp. 725–733.
- Ranck, James B. "Which Elements Are Excited in Electrical Stimulation of Mammalian Central Nervous System: A Review." *Brain Research*, vol. 98, no. 3, 1975, pp. 417–440.
- Roelofs, Theresia J.m., et al. "A Novel Approach to Map Induced Activation of Neuronal Networks Using Chemogenetics and Functional Neuroimaging in Rats: A Proof-of-Concept Study on the Mesocorticolimbic System." *NeuroImage*, vol. 156, 2017, pp. 109–118.
- Roelofs, Theresia J.m., et al. "A Novel Approach to Map Induced Activation of Neuronal Networks Using Chemogenetics and Functional Neuroimaging in Rats: A Proof-of-Concept Study on the Mesocorticolimbic System." *NeuroImage*, vol. 156, 2017, pp. 109–118.
- Roeper, Jochen. "Dissecting the Diversity of Midbrain Dopamine Neurons." *Trends in Neurosciences*, vol. 36, no. 6, 2013, pp. 336–342.



- Rossi, Mark A., et al. "Operant Self-Stimulation of Dopamine Neurons in the Substantia Nigra." *PLoS ONE*, vol. 8, no. 6, 2013.
- Rungta, Ravi L, et al. "Light Controls Cerebral Blood Flow in Naive Animals." *Nature Communications*, vol. 8, 2017, p. 14191., doi:10.1038/ncomms14191.
- Sander, Christin Y, et al. "Imaging Agonist-Induced D2/D3 Receptor Desensitization and Internalization In Vivo with PET/fMRI." *Neuropsychopharmacology*, vol. 41, no. 5, 2015, pp. 1427–1436.
- Schenk, S, et al. "Spatio-Temporal Integration in the Substrate for Self-Stimulation of the Prefrontal Cortex." *Physiology & Behavior*, vol. 35, no. 2, 1985, pp. 303–306.
- Schmid, Florian, et al. "True and Apparent Optogenetic BOLDfMRI Signals." *Magnetic Resonance in Medicine*, vol. 77, no. 1, 2016.
- Schott, B. H., et al. "Mesolimbic Functional Magnetic Resonance Imaging Activations during Reward Anticipation Correlate with Reward-Related Ventral Striatal Dopamine Release." *Journal of Neuroscience*, vol. 28, no. 52, 2008, pp. 14311–14319.
- Schultheis, G. "Brain Stimulation and Addiction" in *Encyclopedia of behavioral neuroscience*. Elsevier, 2010.
- Schultz, W., et al. "Responses of monkey dopamine neurons to reward and conditioned stimuli during successive steps of learning a delayed response task." *Journal of Neuroscience*, vol. 3, no. 13, 1993, pp.900-913.
- Schultz, W., et al. "A Neural Substrate of Prediction and Reward." *Science*, vol. 275, no. 5306, 1997, pp. 1593–1599.
- Scott, Nadia A., and Timothy H. Murphy. "Hemodynamic Responses Evoked by Neuronal Stimulation via Channelrhodopsin-2 Can Be Independent of Intracortical Glutamatergic Synaptic Transmission." *PLoS ONE*, vol. 7, no. 1, 2012.
- Settell, Megan L., et al. "Functional Circuitry Effect of Ventral Tegmental Area Deep Brain Stimulation: Imaging and Neurochemical Evidence of Mesocortical and Mesolimbic Pathway Modulation." *Frontiers in Neuroscience*, vol. 11, Mar. 2017.
- Shih, Y.-Y. I., et al. "A New Scenario for Negative Functional Magnetic Resonance Imaging

- Signals: Endogenous Neurotransmission." *Journal of Neuroscience*, vol. 29, no. 10, Nov. 2009.
- Sik, A., et al. "The Absence of a Major Ca<sup>2+</sup> Signaling Pathway in GABAergic Neurons of the Hippocampus." *Proceedings of the National Academy of Sciences*, vol. 95, no. 6, 1998, pp. 3245–3250.
- Smith, A. J., et al. "Cerebral Energetics and Spiking Frequency: The Neurophysiological Basis of fMRI." *Proceedings of the National Academy of Sciences*, vol. 99, no. 16, 2002, pp. 10765–10770.
- Steidl, Stephan, et al. "Optogenetic Excitation in the Ventral Tegmental Area of Glutamatergic or Cholinergic Inputs from the Laterodorsal Tegmental Area Drives Reward." *European Journal of Neuroscience*, vol. 45, no. 4, 2016, pp. 559–571.
- Steinberg, Elizabeth E, et al. "A Causal Link between Prediction Errors, Dopamine Neurons and Learning." *Nature Neuroscience*, vol. 16, no. 7, 2013, pp. 966–973.
- Steinberg, Elizabeth E., et al. "Positive Reinforcement Mediated by Midbrain Dopamine Neurons Requires D1 and D2 Receptor Activation in the Nucleus Accumbens." *PLoS ONE*, vol. 9, no. 4, 2014.
- Stuber, G. D., et al. "Dopaminergic Terminals in the Nucleus Accumbens But Not the Dorsal Striatum Corelease Glutamate." *Journal of Neuroscience*, vol. 30, no. 24, 2010, pp. 8229–8233.
- Tan, Kelly R., et al. "GABA Neurons of the VTA Drive Conditioned Place Aversion." *Neuron*, vol. 73, no. 6, 2012, pp. 1173–1183.
- Taylor, Seth R., et al. "GABAergic and Glutamatergic Efferents of the Mouse Ventral Tegmental Area." *Journal of Comparative Neurology*, vol. 522, no. 14, 2014, pp. 3308–3334.
- Thanos, P. K., et al. "Mapping Brain Metabolic Connectivity in Awake Rats with PET and Optogenetic Stimulation." *Journal of Neuroscience*, vol. 33, no. 15, Oct. 2013, pp. 6343–6349.
- Trantham-Davidson, H. "Mechanisms Underlying Differential D1 versus D2 Dopamine

- Receptor Regulation of Inhibition in Prefrontal Cortex.” *Journal of Neuroscience*, vol. 24, no. 47, 2004, pp. 10652–10659.
- Tritsch, Nicolas X, et al. “Midbrain Dopamine Neurons Sustain Inhibitory Transmission Using Plasma Membrane Uptake of GABA, Not Synthesis.” *ELife*, vol. 3, 2014.
- Tritsch, Nicolas X., et al. “Dopaminergic Neurons Inhibit Striatal Output through Non-Canonical Release of GABA.” *Nature*, vol. 490, no. 7419, Mar. 2012, pp. 262–266.
- Tritsch, Nicolas X., et al. “Mechanisms and Functions of GABA Co-Release.” *Nature Reviews Neuroscience*, vol. 17, no. 3, Nov. 2016, pp. 139–145.
- Tsai, H.-C., et al. “Phasic Firing in Dopaminergic Neurons Is Sufficient for Behavioral Conditioning.” *Science*, vol. 324, no. 5930, 2009, pp. 1080–1084.
- Ungless, Mark A., et al. “Uniform Inhibition of Dopamine Neurons in the Ventral Tegmental Area by Aversive Stimuli.” *Science*, vol. 303, no. 5666, 2004, pp. 2040–2042.
- Ungless, Mark A., and Anthony A. Grace. “Are You or Aren’t You? Challenges Associated with Physiologically Identifying Dopamine Neurons.” *Trends in Neurosciences*, vol. 35, no. 7, 2012, pp. 422–430.
- Urban, Nina B. L., et al. “Imaging Human Reward Processing with Positron Emission Tomography and Functional Magnetic Resonance Imaging.” *Psychopharmacology*, vol. 221, no. 1, Apr. 2011, pp. 67–77.
- van Zessen, Ruud, et al. “Activation of VTA GABA Neurons Disrupts Reward Consumption.” *Neuron*, vol. 73, no. 6, 2012, pp. 1184–1194.
- Wang, Dong V., et al. “Disrupting Glutamate Co-Transmission Does Not Affect Acquisition of Conditioned Behavior Reinforced by Dopamine Neuron Activation.” *Cell Reports*, vol. 18, no. 11, 2017, pp. 2584–2591.
- Wise, R. A. “Addictive Drugs and Brain Stimulation Reward.” *Annual Review of Neuroscience*, vol. 19, no. 1, Jan. 1996, pp. 319–340.
- Witten, Ilana B., et al. “Recombinase-Driver Rat Lines: Tools, Techniques, and Optogenetic Application to Dopamine-Mediated Reinforcement.” *Neuron*, vol. 72, no. 5, 2011, pp. 721–733.

Xia, Y., et al. "Nucleus Accumbens Medium Spiny Neurons Target Non-Dopaminergic Neurons in the Ventral Tegmental Area." *Journal of Neuroscience*, vol. 31, no. 21, 2011, pp. 7811–7816.

Yoo, Ji Hoon, et al. "Ventral Tegmental Area Glutamate Neurons Co-Release GABA and Promote Positive Reinforcement." *Nature Communications*, vol. 7, 2016, p. 13697.